

XL³ 400

201 53/54/55/56/57/73/74/75/76/77

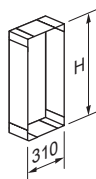

H (mm)	Réf.	H (mm)	Réf.
600	201 53	600	201 73
750	201 54	750	201 74
900	201 55	900	201 75
1050	201 56	1050	201 76
1200	201 57	1200	201 77

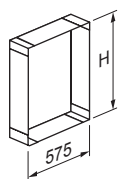
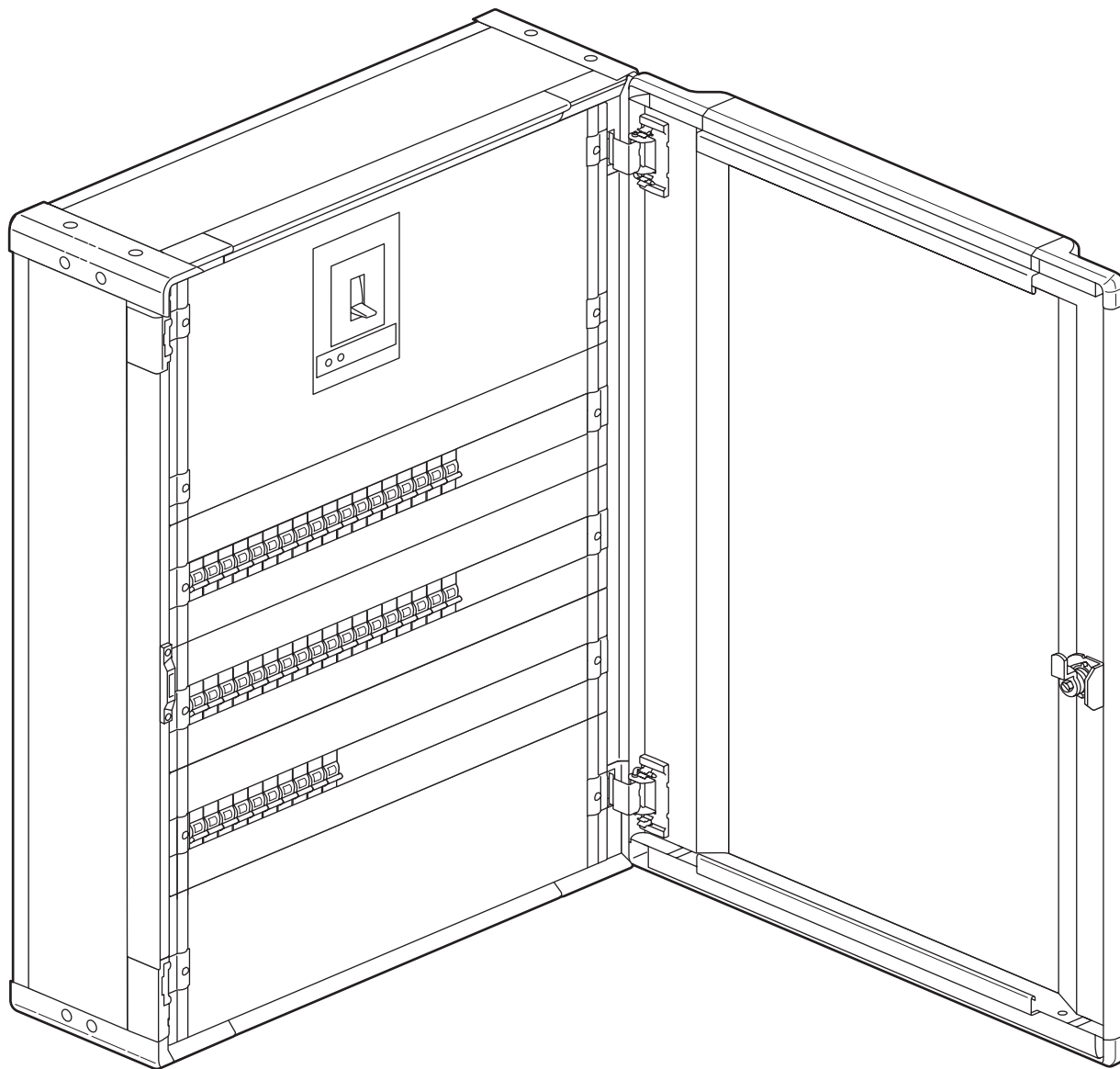
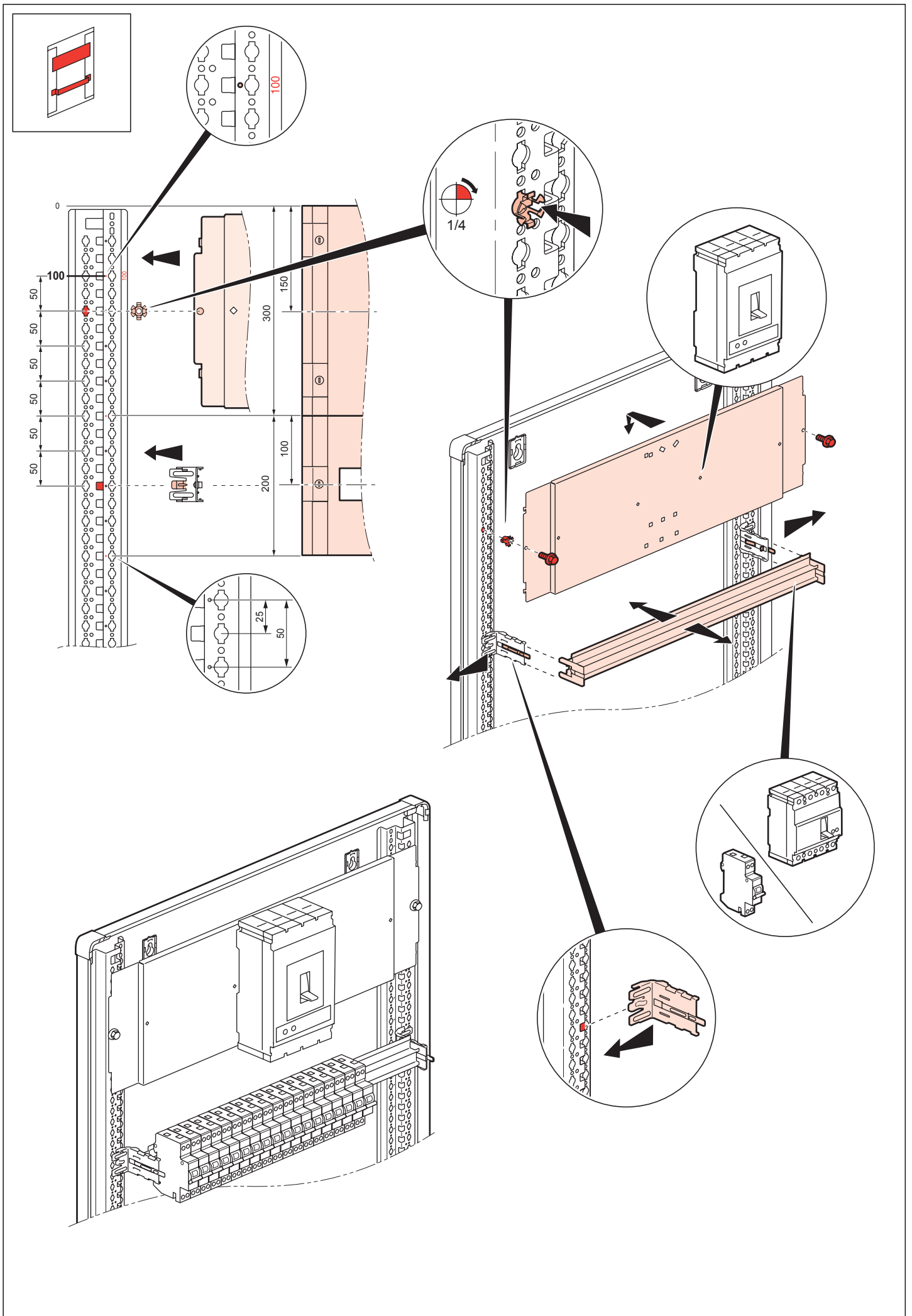

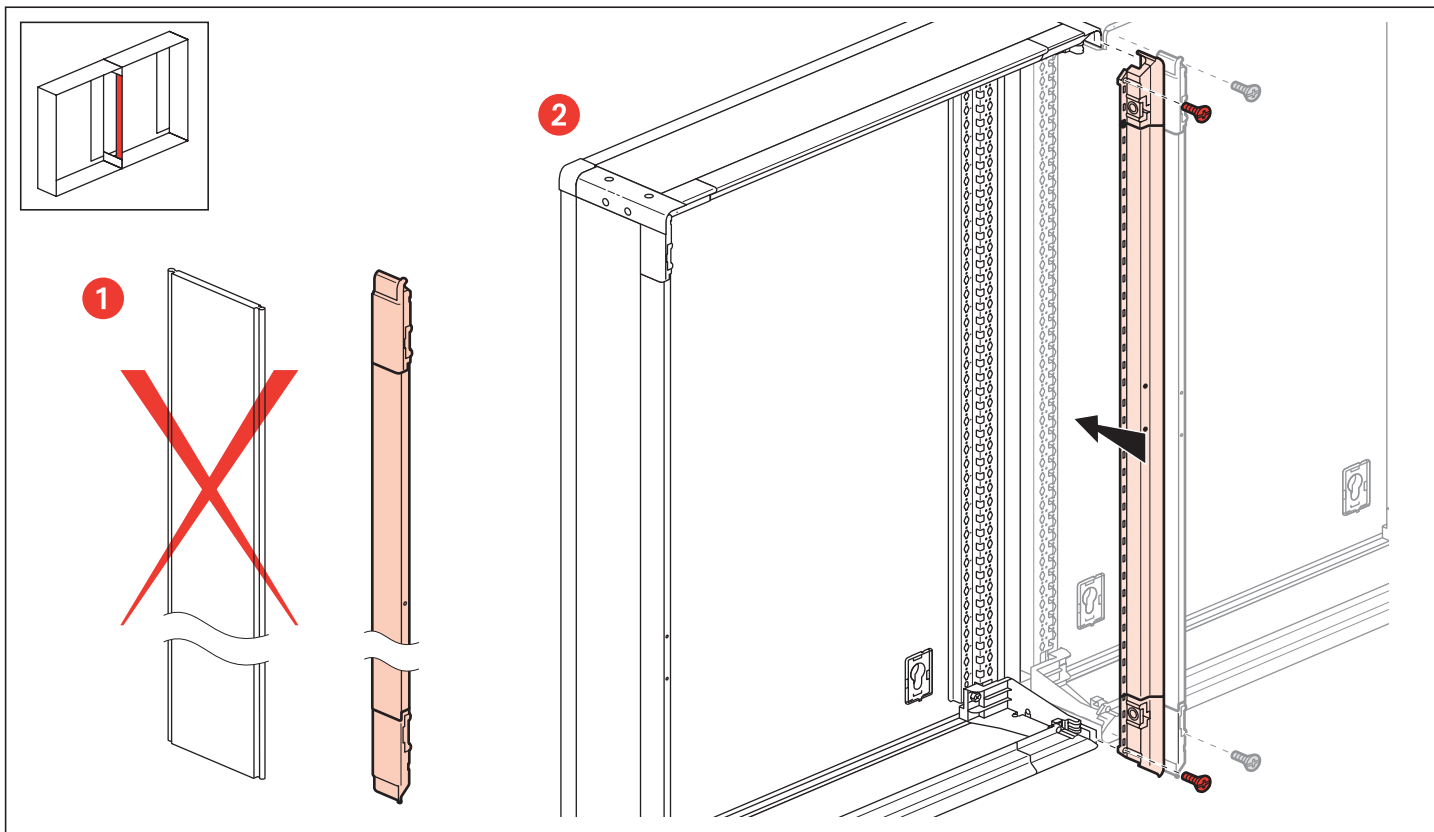
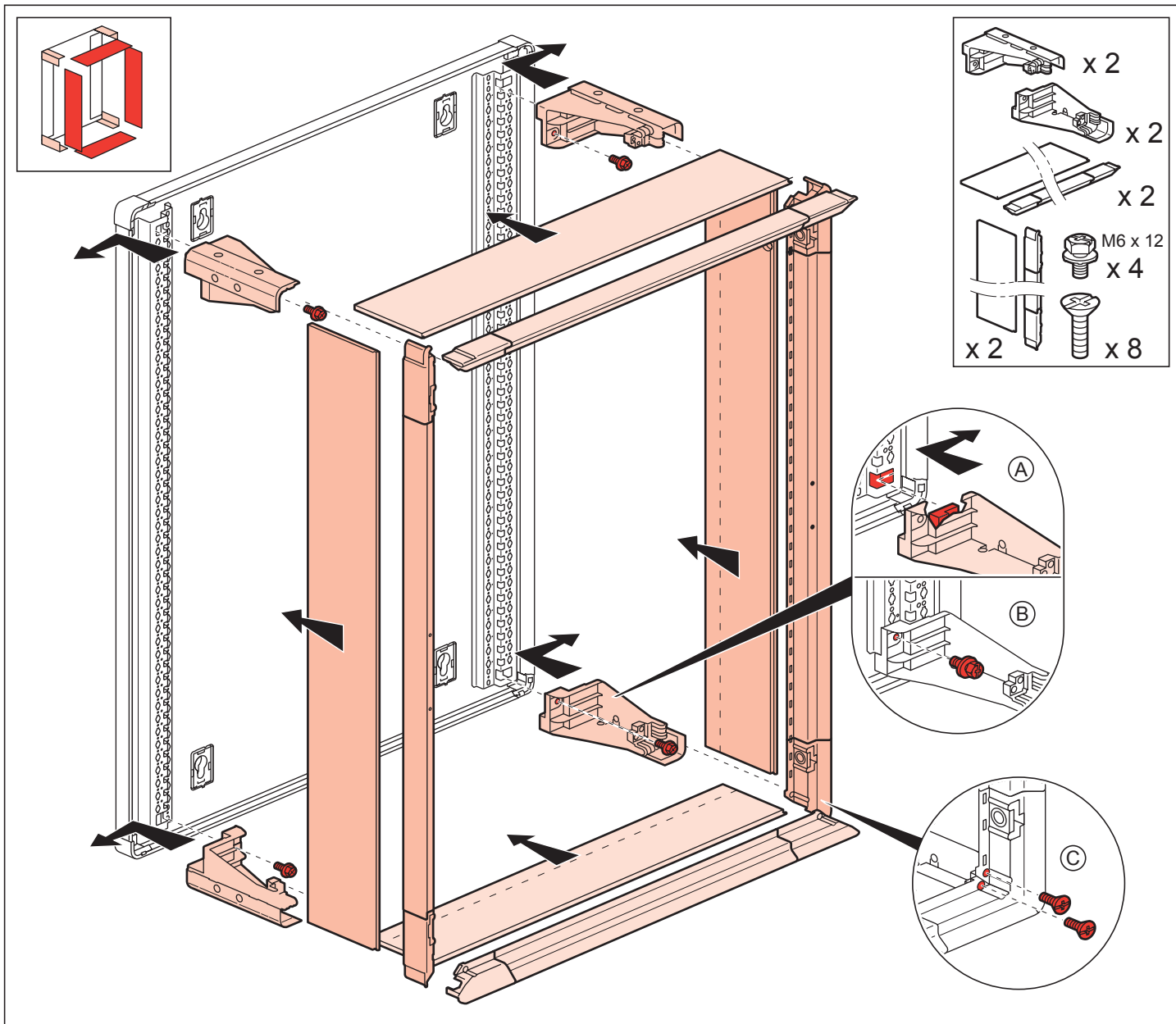

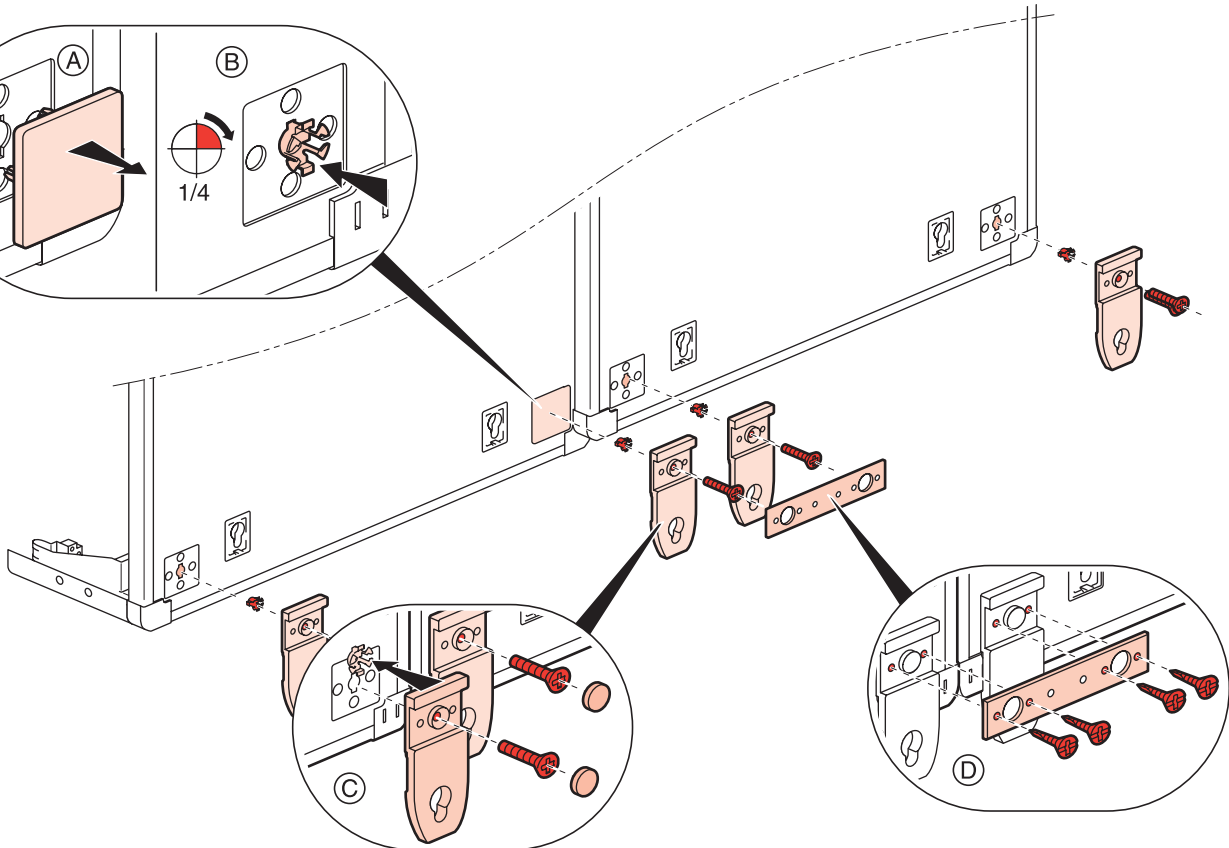
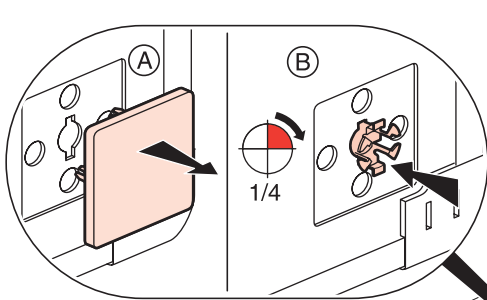
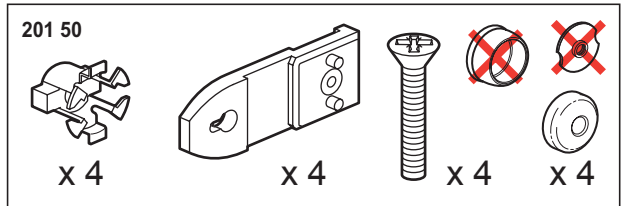
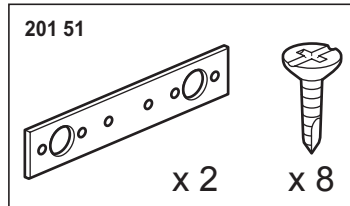
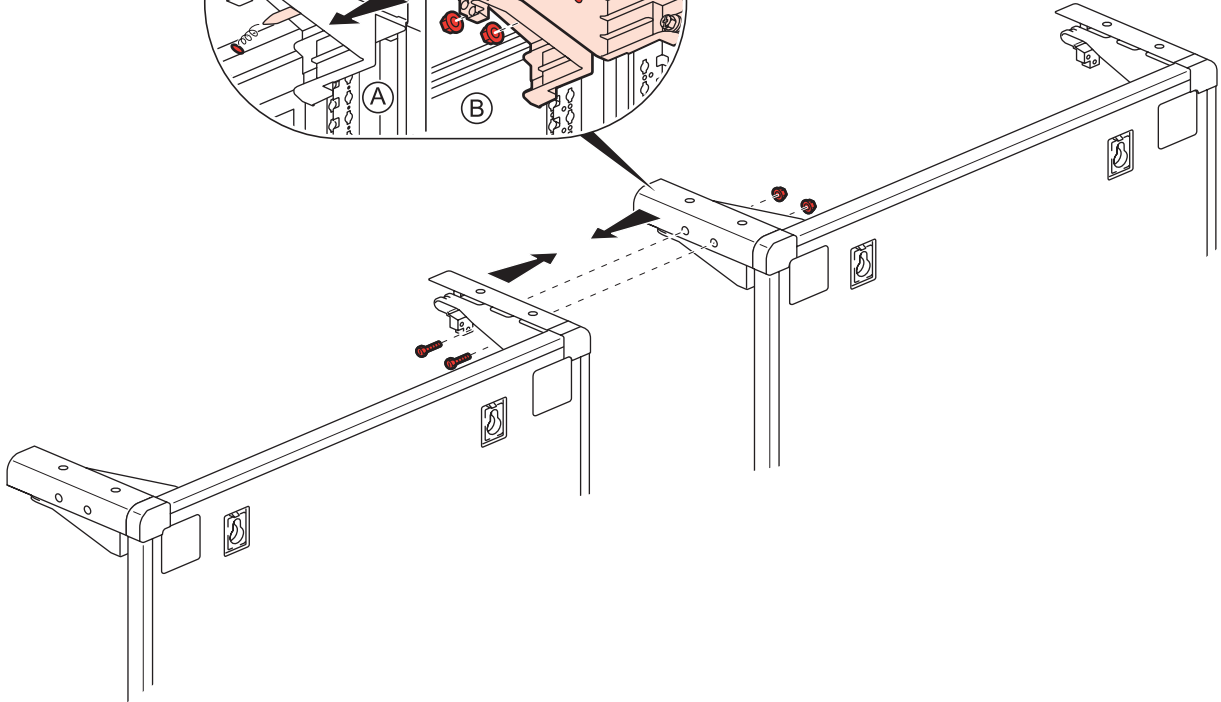
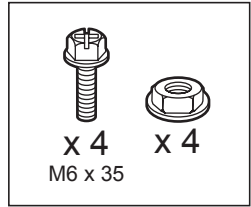
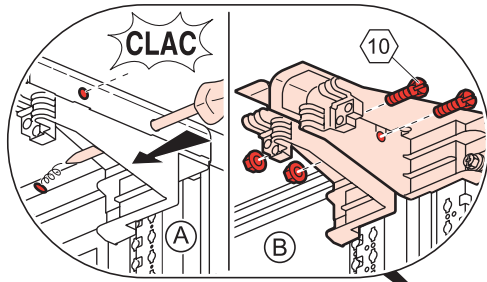
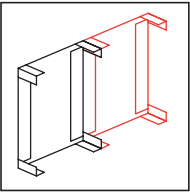

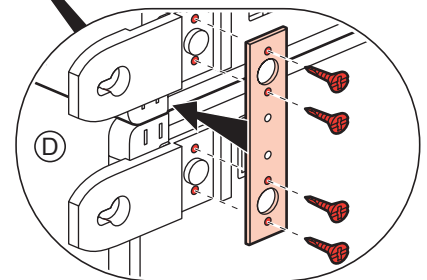
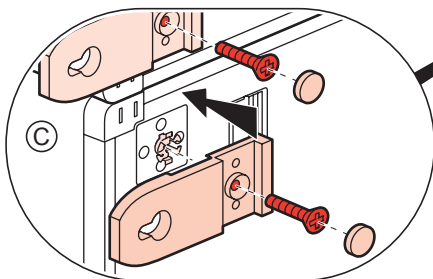
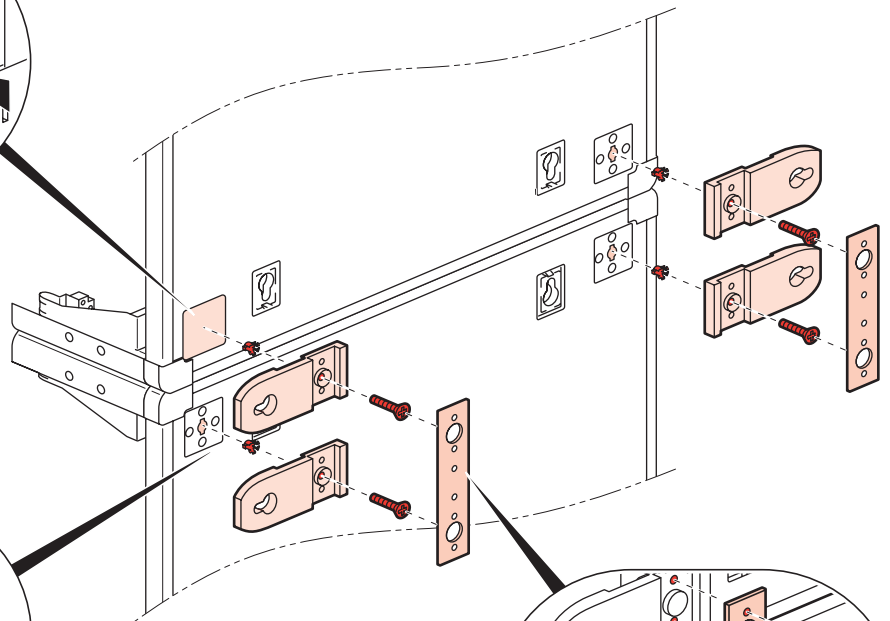
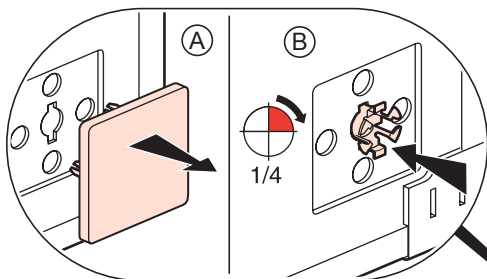
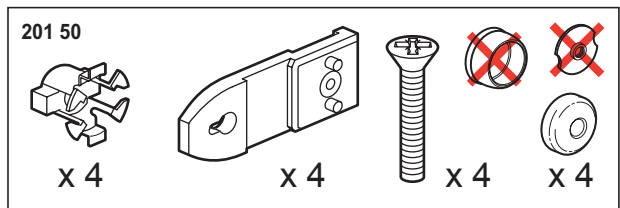
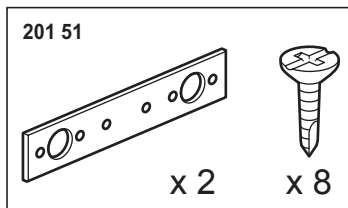
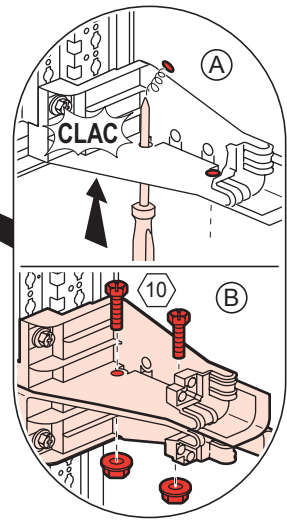
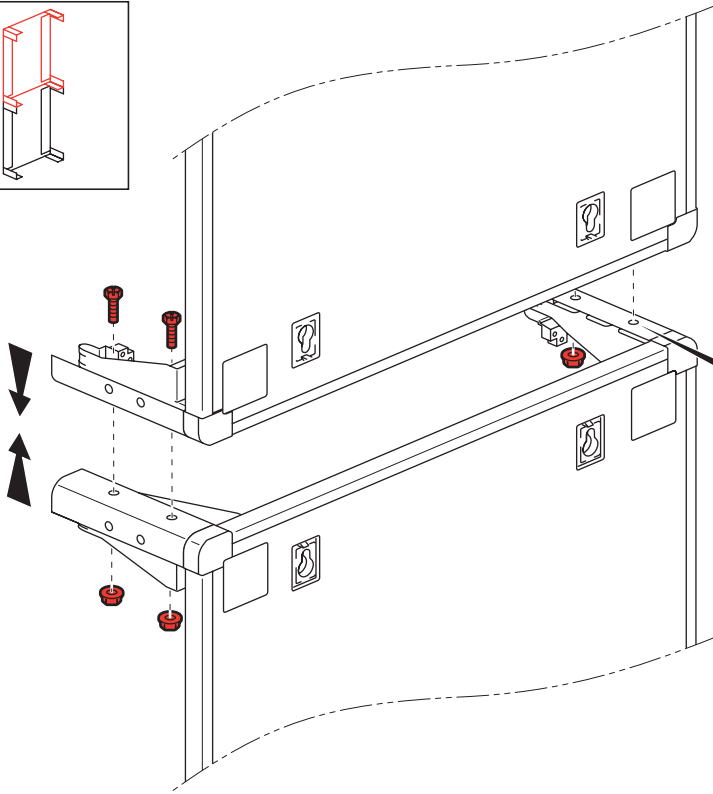
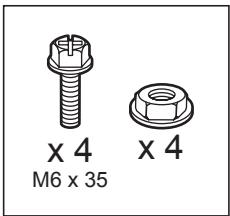
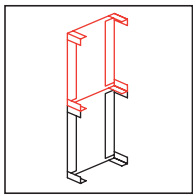

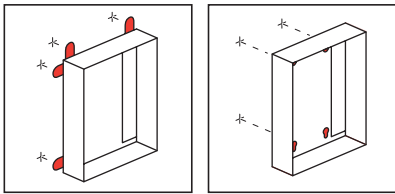

201 50



x 4

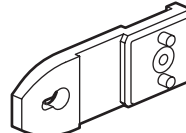

x 4

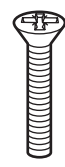

x 4

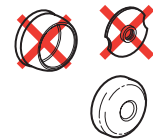

x 4

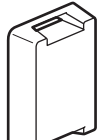

x 4

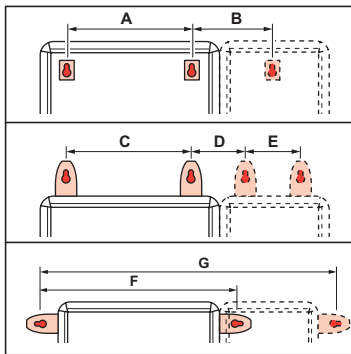
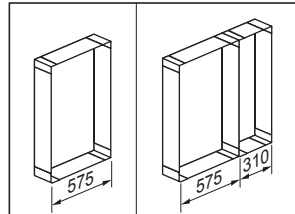

A = 330

A = 330
B = 277,5

C = 475

C = 475
D = 100
E = 210

F = 625

G = 935

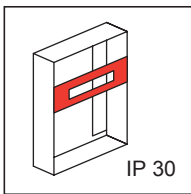
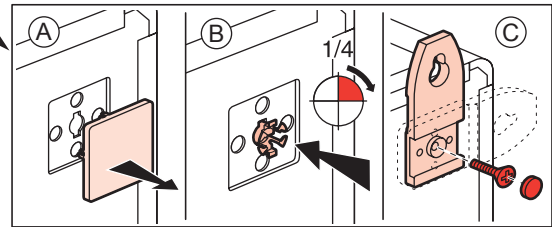
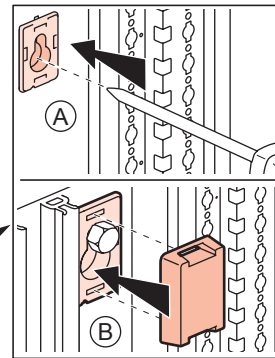

IP 30

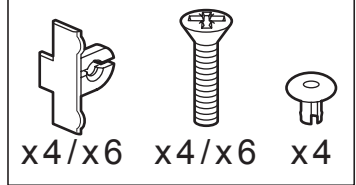

x4/x6

x4/x6

x4

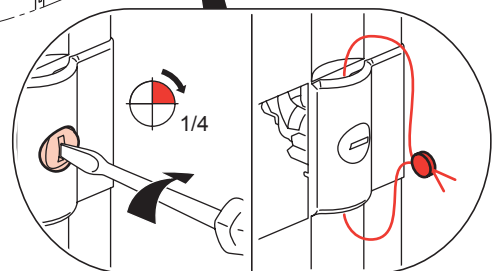
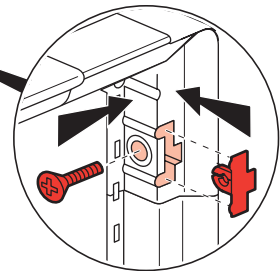
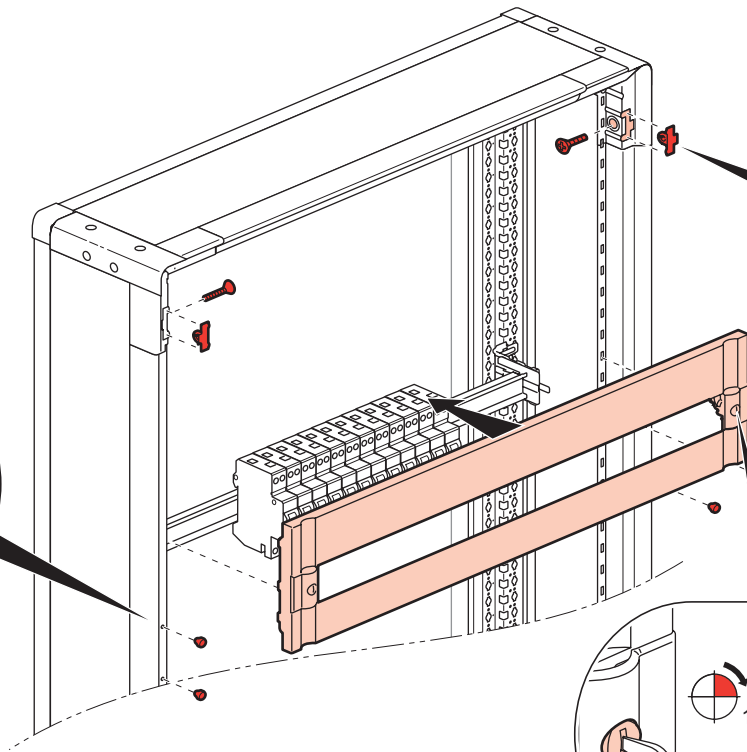
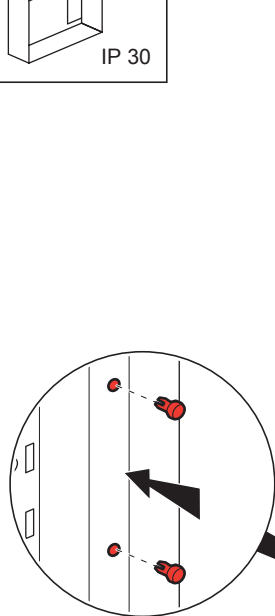

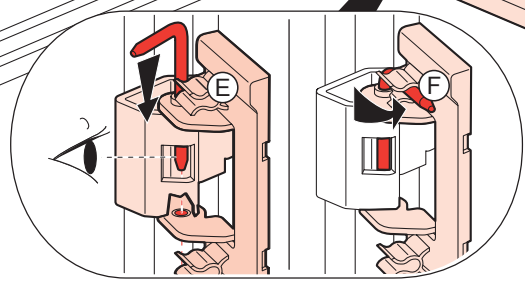
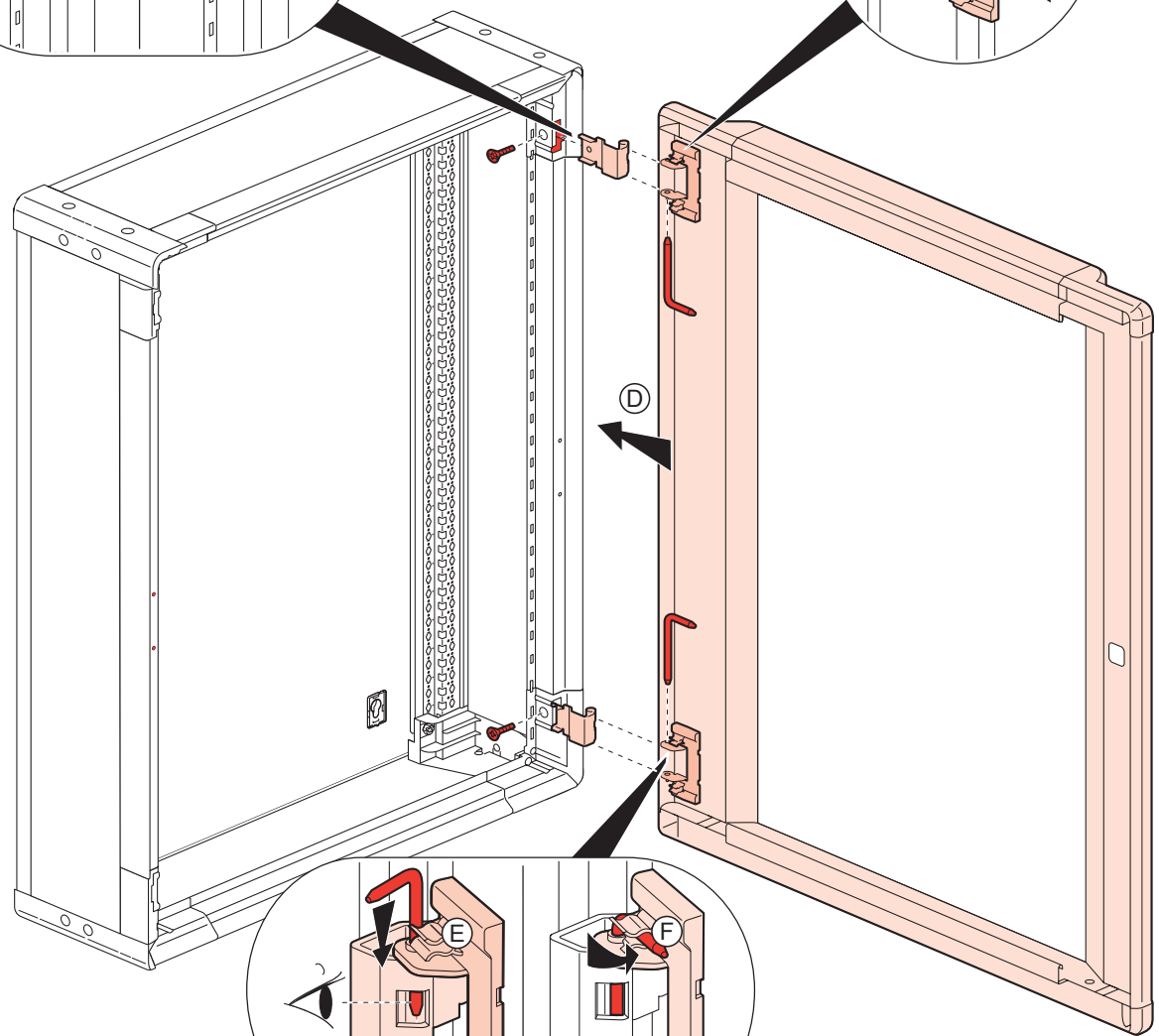
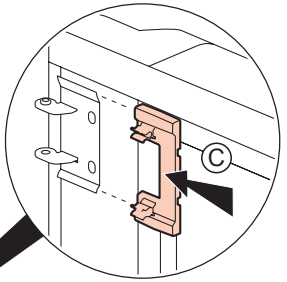
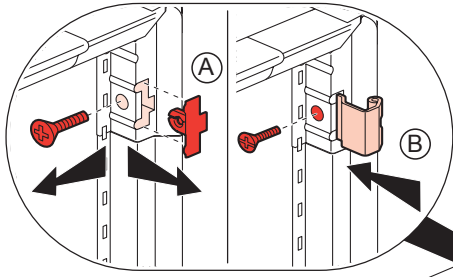
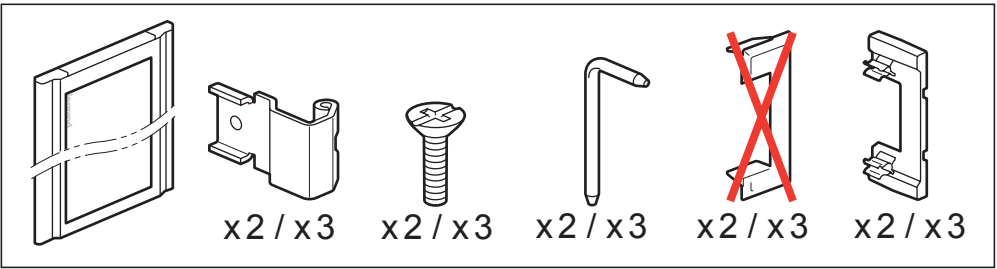
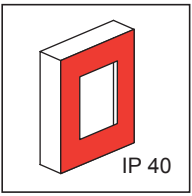

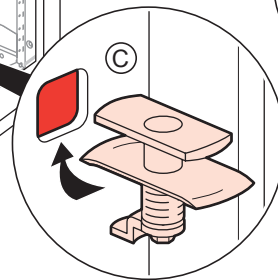
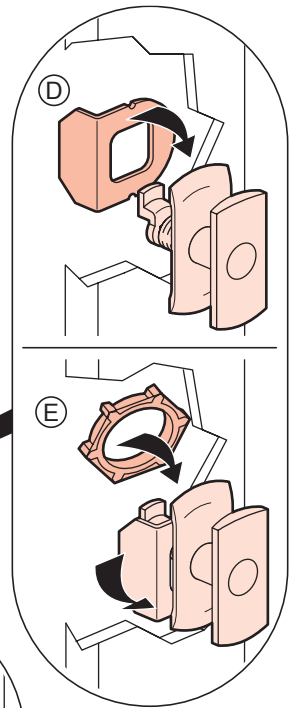
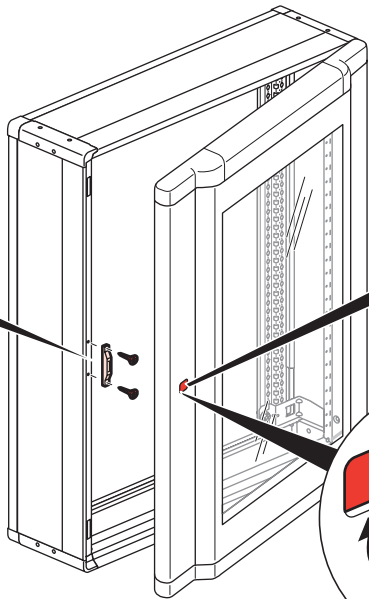
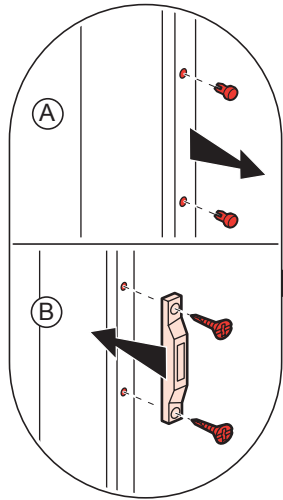
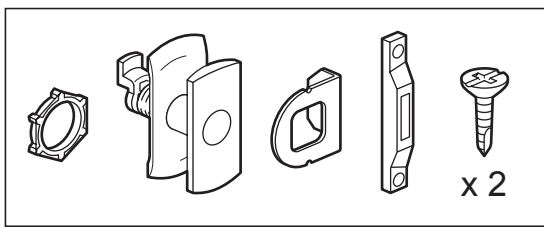
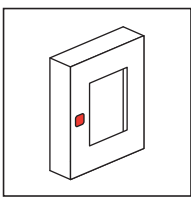

	202 91 N° 405
	202 92 N° 455
	202 93 1242 E
	202 94 2433 A
	202 96

