

Contents

1. System requirements	4
2. Compatible Devices	5
2.1 Measuring / metering devices	5
2.2 Devices without measuring / metering data	5
3. Languages available	6
4. Implementation	6
4.1 Local settings	6
4.2 Connecting the device to a PC - Programming	6
4.3 Display default settings	6
4.4 LAN configuration of the computer	7
4.5 Configuration of the Panel Board Display	9
4.5.1 Network Settings: personal configuration	9
4.6 Data and Time settings	13
4.7 Changing of the Panel Board Display's language	15
4.8 Remote settings	16
4.9 Connection scheme of the Display to the Network- Normal Use	16
4.10 Configuration of the electric installation in the Panel Board Display - System configuration	17
4.10.1 Gateways and Devices configuration	18
4.10.2 Loads configuration	26
4.10.3 Bill of Energy configuration	30
5. Use	31
5.1 Access	31
5.1.1 Access rights	31
5.1.2 Creating a new User	32
5.1.3 Changing of the access rights	33
5.1.4 Logout procedure	34
5.2 Data display pages	35
5.2.1 Devices	35
6. Backup and Restore	37
6.1 Backup procedure	37
6.2 Restore procedure	39
7. Network type and access mode	41
7.1 LAN/Intranet	41
7.1.1 Ports	41
7.2 WAN/Internet	42
7.2.1 Ports	43

1. System requirements

Display possible on:

- PC (Web Browser):
 - Internet Explorer : version 8.0 and following (v8.0+)
 - Firefox : v4.0+
 - Chrome : v12.0+
 - Opera : v11.0+
 - Safari : v5.0+
- Tablet (Device, Operating system, Browser):
 - iPad (all versions), iOS 4+, Safari

“Panel Board Display”

- Management up to 8 devices

Software version 1.0.10

2. Compatible devices

2.1 Measuring / metering devices

- Range **EMDX³**
 - Multifunction measuring devices:
 - Modular - Cat. No **046 76**
 - Standard - Cat. No **146 68**
 - Top - Cat. No **146 69**
 - Energy counters RS485 :
 - Single-phase direct connection – Cat.Nos **046 77** (Standard), **046 79** (MID)
 - Three-phase direct connection – Cat.Nos **046 80** (Standard), **046 83** (MID)
 - Three-phase connection with CT – Cat.Nos **046 84** (Standard), **046 86** (MID)
 - Energy counters pulse output (with the Concentrator Cat. No **046 87**):
 - Single-phase direct connection – Cat.Nos **046 70/72/81** (Standard), **046 78** (MID)
 - Three-phase direct connection – Cat.Nos **046 73** (Standard), **046 82** (MID)
 - Three-phase connection with CT – Cat.Nos **046 74** (Standard), **046 85** (MID)
- Range **DPX³**
 - **DPX³ 250 electronic** only versions with **integrated measurement unit**
 - via the communication module Cat.No **4 210 75**
- Range **DMX³** with protection unit – touchscreen (Cat.Nos **288 03/04**)
 - via the communication module Cat.No **288 05**

2.2 Devices without measuring / metering data

- Range **DPX³**
 - **DPX³ 160 thermal-magnetic with integrated RCD**
 - **DPX³ 250 electronic, electronic with integrated RCD and thermal-magnetic with integrated RCD**
 - via the communication module Cat.No **4 210 75**
- Range **DMX³** with protection unit – LCD screen (Cat.Nos **288 00/01/02**)
 - via the communication module Cat.No **288 05**

3. Languages available

Languages:

- English
- Italian
- Spanish
- Russian

4. Implementation

4.1 Local settings

Local settings / configurations

- Procedure to configure the Display from a computer directly connected to it.

Materials required

- Panel Board Display's instruction sheet
- Panel Board Display's user manual
- PC with a web browser (IE8+, Firefox, etc.)

Useful information

- IP network parameters for the Display (use the **Parameters Table of the Panel Board Display** contained in the CD Rom)

4.2 Connecting the device to a PC - Programming

- Connect the Display directly to a PC by the Ethernet cable. (is possible to pass through a switch)
 - **Note:** In this phase don't connect the Display to other devices (Gateways, etc.) or to the Building Network
- Supply the Display

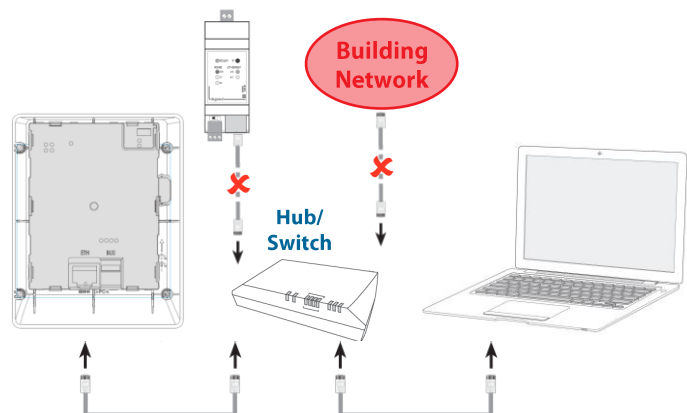

4.3 Display default settings

- IP Address: 192.168.1.100
- Subnet Mask: 255.255.255.0
- Default Gateway: 192.168.1.1

Note: Display and Gateway have the same default settings

4.4 LAN configuration of the computer

Follow the procedure:

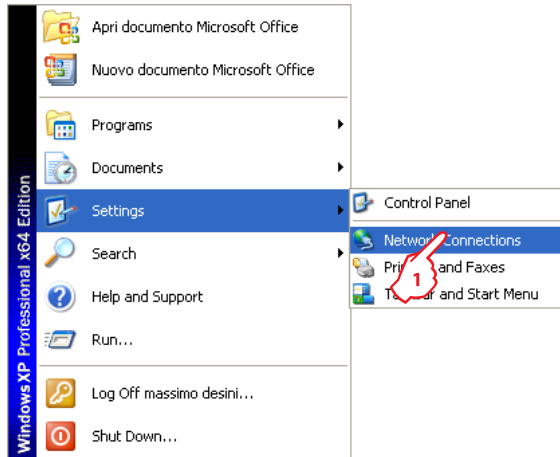

1. In the Start menu choose "Settings" then click "Network Connections"

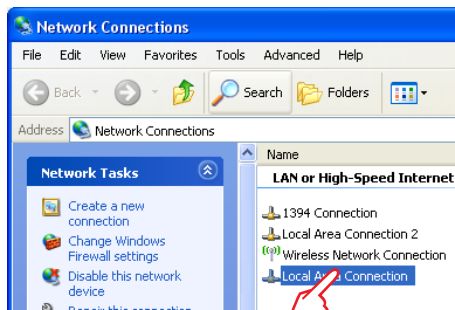

2. Click "Local Area Connection"

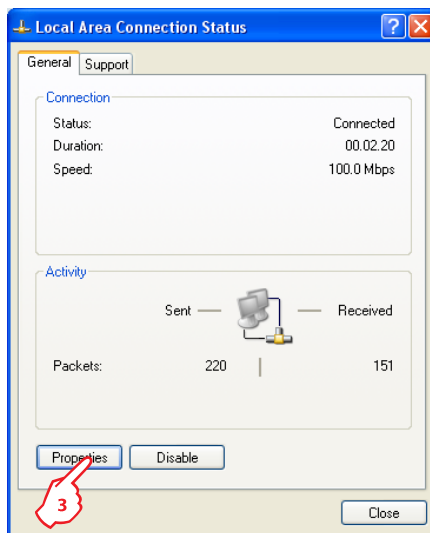

3. Click "Properties"

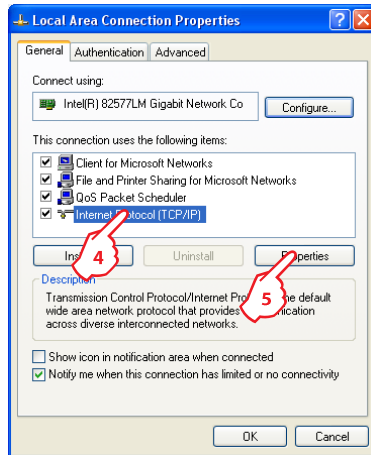

4. Click "Internet Protocol (TCP/IP)"
5. Click "Properties"

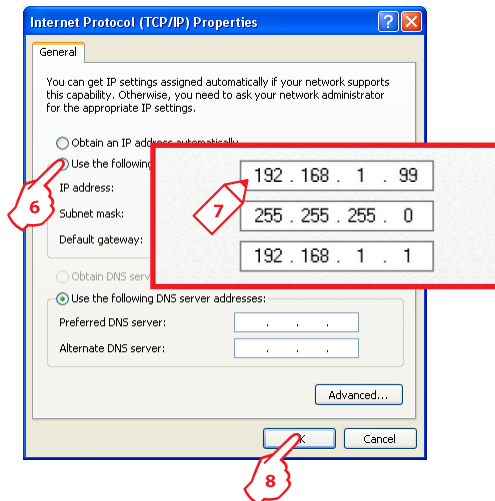

6. Click "Use the following IP address"
7. Enter the LAN parameters as shown
8. Click "OK" to confirm

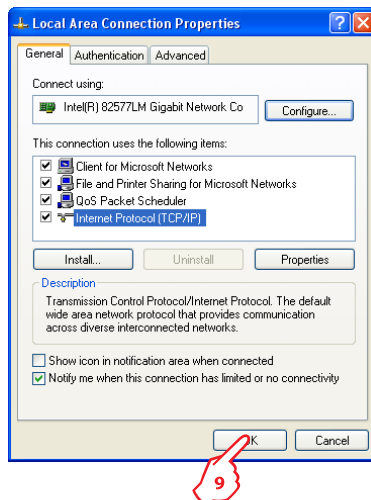

9. Click "OK" to confirm

4.5 Configuration of the Panel Board Display

4.5.1 Network Settings - Personal configuration

To access to the Display, type the IP address **192.168.1.100** (default IP) in the web browser.



Panel Board Display's Home page appears

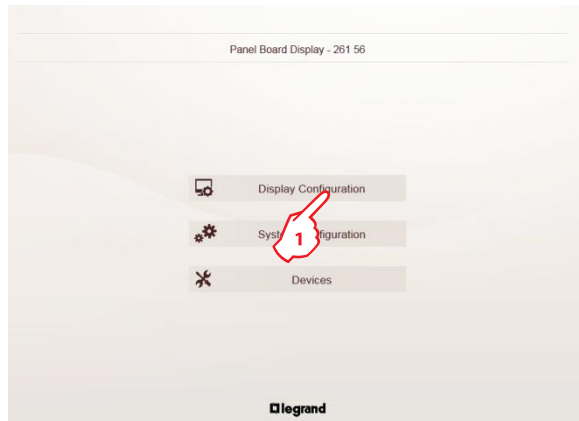

1. Click "Display configuration"

Login page appears

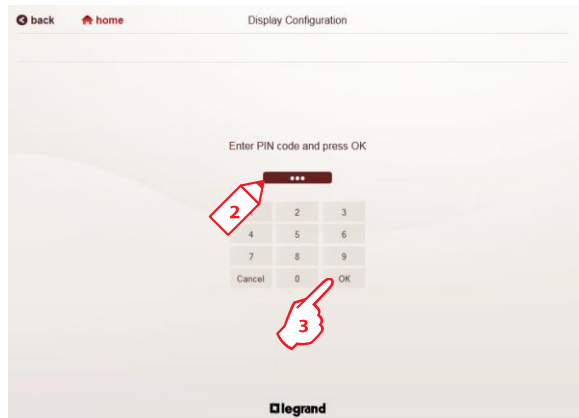

2. Type the access PIN code **99999** (default PIN)

3. Click "OK"

Panel Board Display's configuration page appears

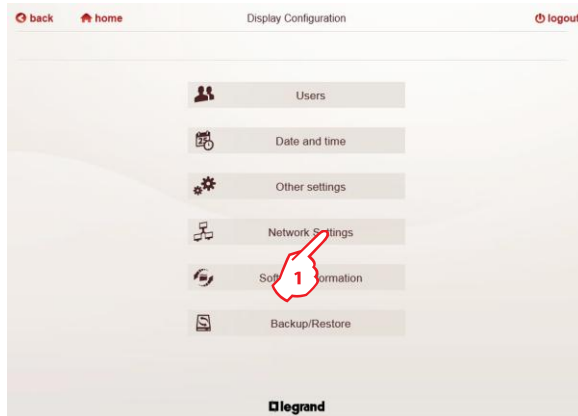

1. Click "Network settings" to configure the LAN properties of the Display

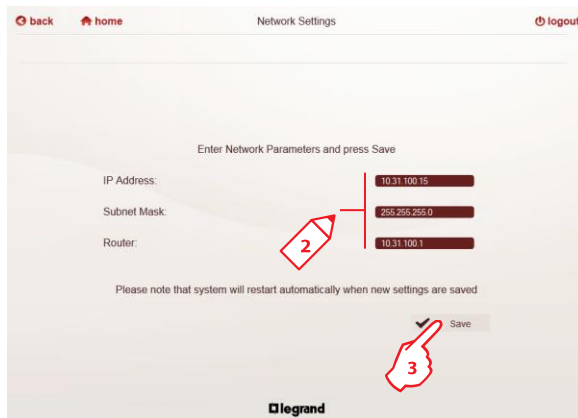

2. Enter the new LAN settings

example of IP network settings to configure on the Display

- IP Address: **10.31.100.15**
- Subnet mask: **255.255.255.0**
- Default gateway: **10.31.100.1**

3. Click "Save" to confirm

Note: the device restart automatically.

- After changing of the Network parameters of the Display, it is necessary to reset the LAN parameters of the PC as shown below:

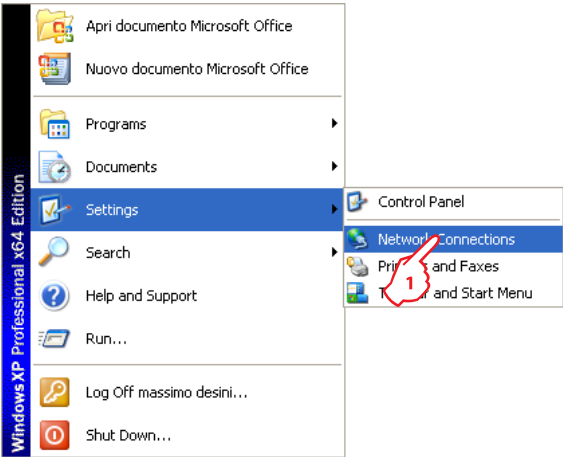

1. In the Start menu choose “Settings” then click “Network Connections”

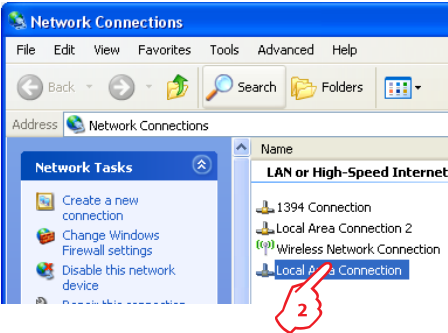

2. Click “Local Area Connection”

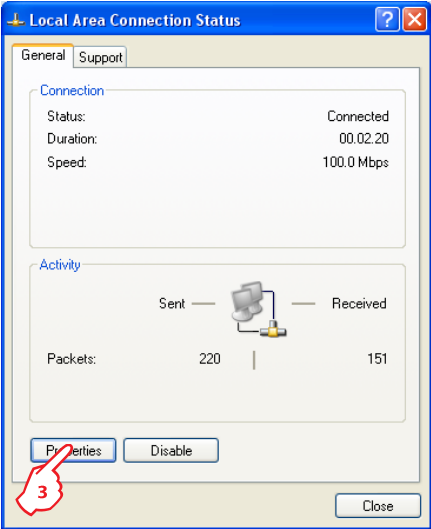

3. Click “Properties”

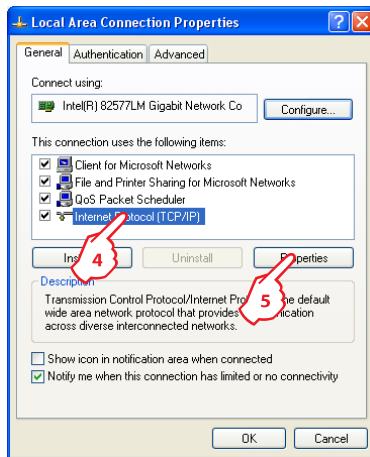

4. Click "Internet Protocol (TCP/IP)"
5. Click "Properties"

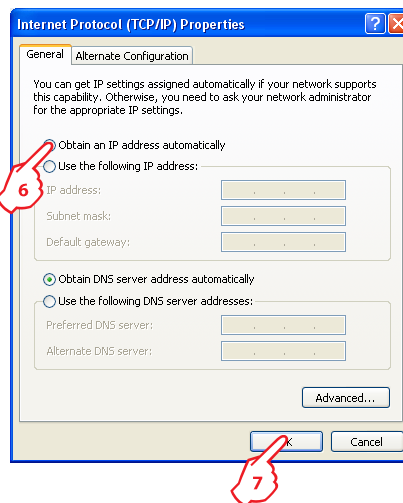

6. Click "Obtain an IP address automatically"
7. Click "OK" to confirm

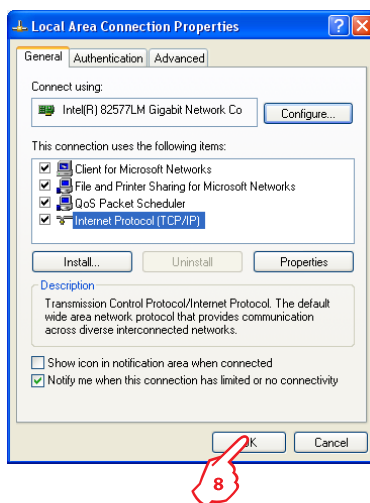

8. Click "OK" to confirm

4.6 Data and Time settings

Connect to the Display typing the **new IP address** (**10.31.100.15** in the example) in the web browser.

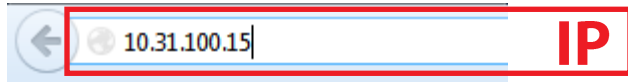

Panel Board Display's Home page appears

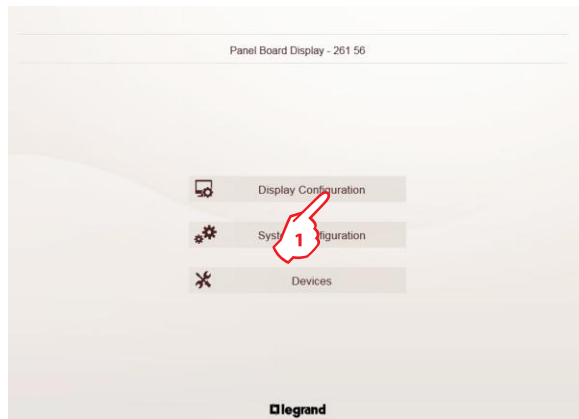

1. Click "Display configuration"

Login page appears

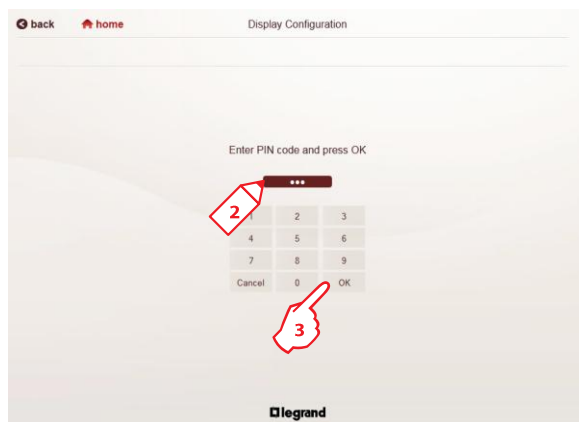

2. Type the access PIN code **99999** (default PIN)

3. Click "OK"

Panel Board Display's configuration page appears

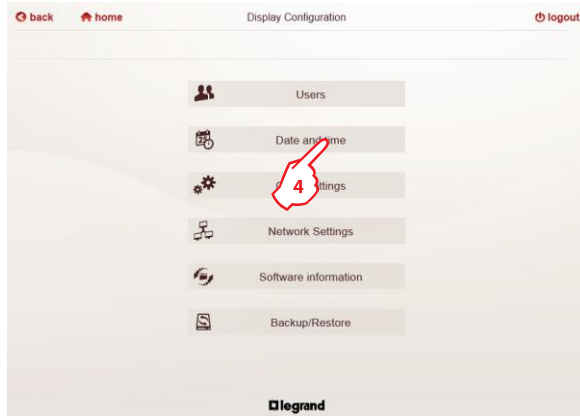

4. Click "Data and Time" to set these parameters on the device

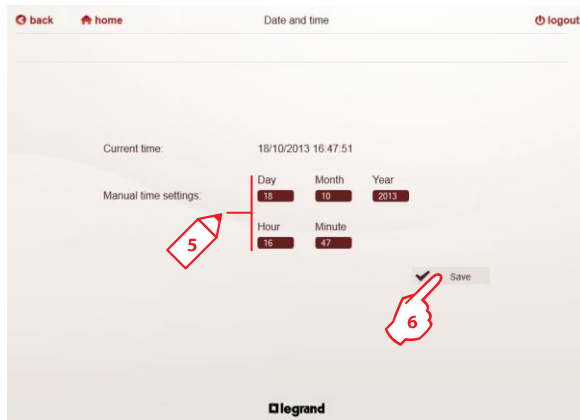

- 5. Enter the new parameters:
 - Date: day, month and year
 - Time: hour and minutes
- 6. Click "Save" to confirm

4.7 Changing of the Panel Board Display's language

– Procedure for changing the language

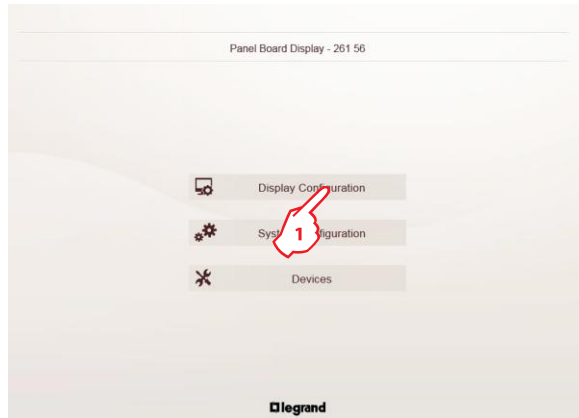

In the Panel Board Display's home page

1. Click "Display configuration"

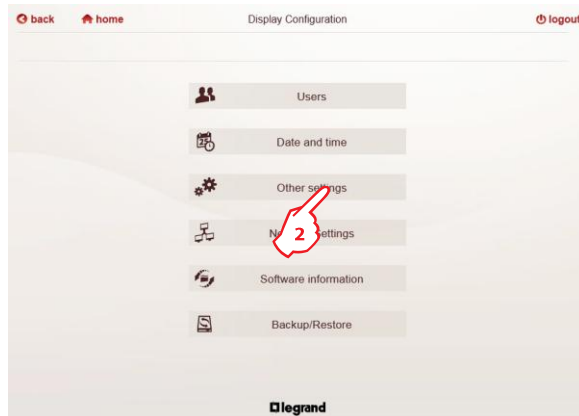

2. Click "Other settings"

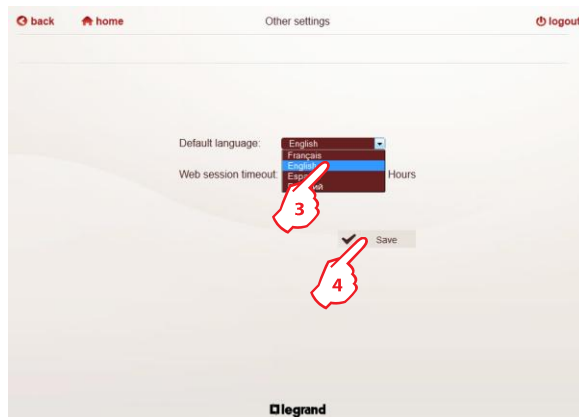

3. Choose the proper language from the list box

4. Click "Save" to confirm

4.8 Remote settings

Settings / configurations of the electrical installation

- Procedure to configure the different devices on the panel board display

Materials required

- Panel Board Display's user manual
- A computer with a web browser (IE8+, Firefox, etc.)

Useful Information

- Network and RS485 bus parameters for Gateways and Devices (use the [Parameters Table of the Panel Board Display](#) contained on the CD Rom)

4.9 Connection scheme of the Display to the Network - Norma Use

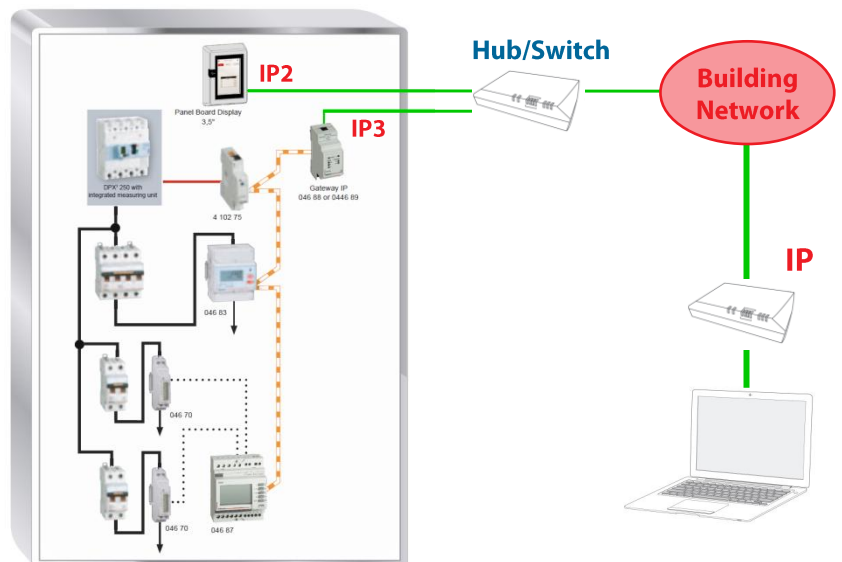

4.10 Configuration of the electric installation in the Panel Board Display - "System configuration"

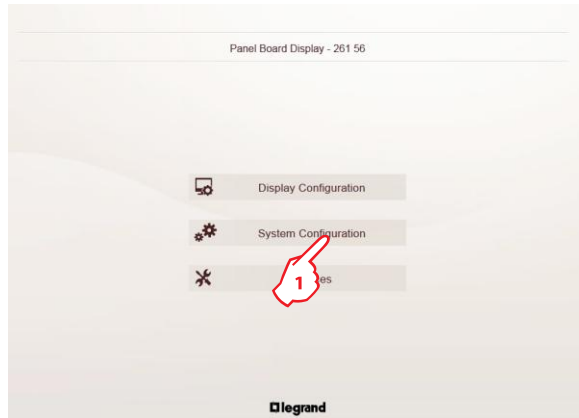

1. In the device's home page click "System configuration"

Login page appears

Note: If a user is already logged-in, the device doesn't ask the PIN. Otherwise if no user is logged-in, the login page appears and is necessary perform the access typing the PIN code.

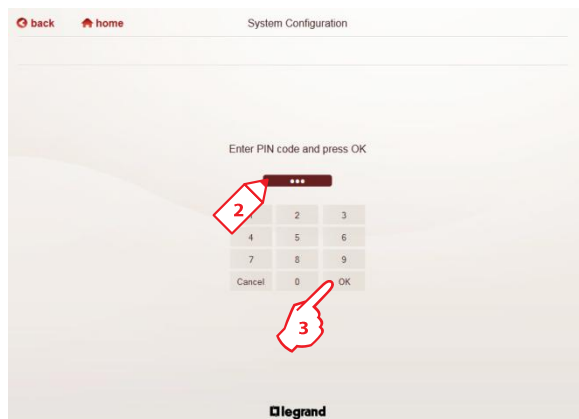

2. Type the access PIN code 99999 or 55555 (default PIN)

3. Click "OK"

System configuration page appears

– Configuration sequence:

- Gateways and Devices configuration
- Loads, configurations
- Bill of Energy configuration

4.10.1 Gateways and Devices configuration

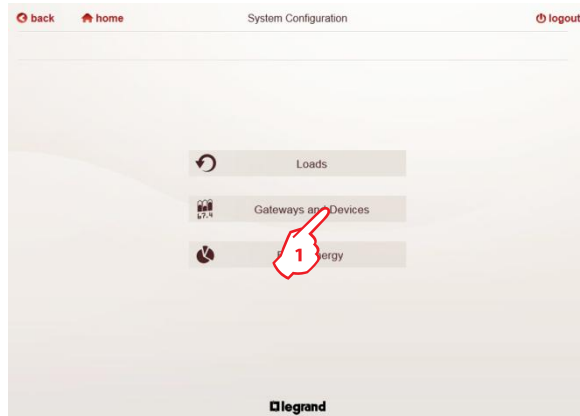

1. Click "Gateways and devices"
Gateway's settings page appears

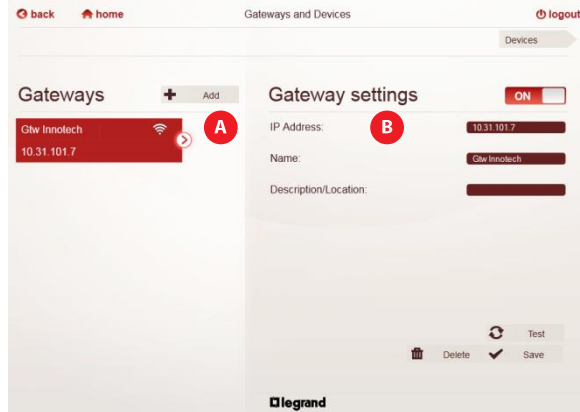

The page is divided into two sections:
section **A** is the "Added Gateway" area.
section **B** shows the "Gateway Settings" area, where the configuration fields for the selected gateway are available.

• CREATING AND SAVING A GATEWAY

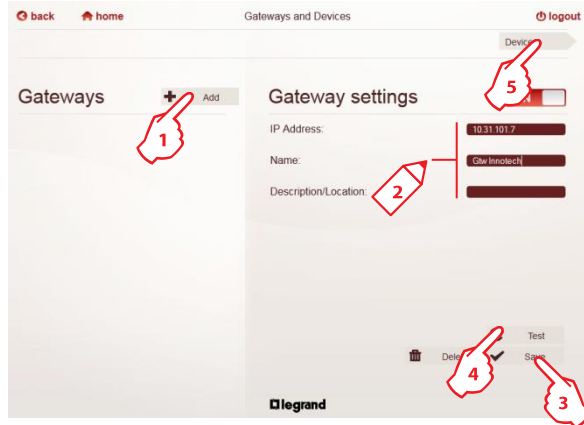



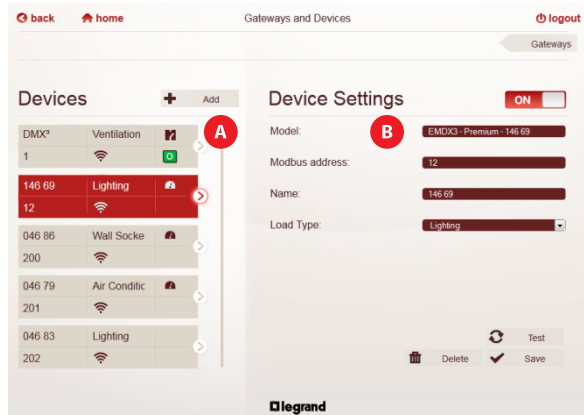

1. Click "Add"
2. Assign the gateway parameters:
 - IP Address (required parameter)
 - Name (required parameter)
 - Description/Location (optional parameter)
3. Click "Save"
4. Click "Test" to verify the correct operation of the communication between the Display and the Gateway
5. Click "Devices" to configure the Devices connected to the Gateway
Devices settings page appears

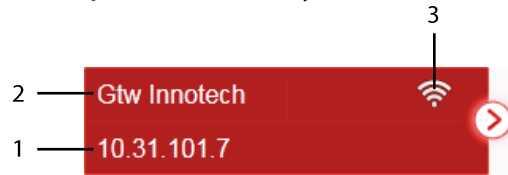

The page is divided into two sections:
 section **A** is the "Added Devices" area.
 section **B** shows the "Device Settings" area, where the configuration fields for the selected device are available.

• **Description of the Gateway selection button**



- 1. IP address assigned to the gateway
- 2. Name of the gateway
- 3. Communication status
 -  On
 -  Off
 -  Communication error

• **CREATING AND SAVING DEVICES (max 8 devices)**

- Procedure for Measure device with RS485 output

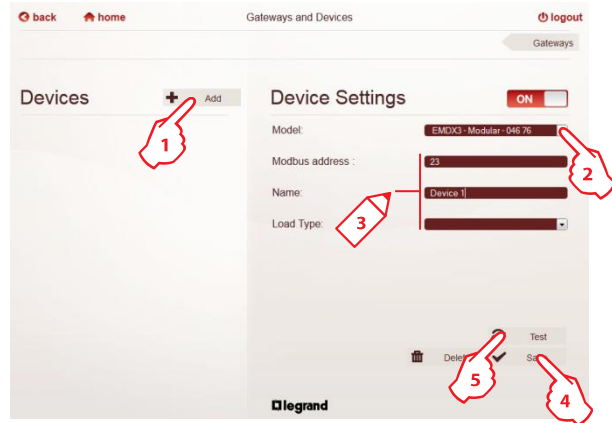

1. Click "Add"
 2. Choose the Model from the models list
 3. Assign the Device parameters:
 - Modbus address (required parameter)
 - Name (required parameter)
 - Load type (optional parameter)
 4. Click "Save"
 5. Click "Test" to verify the correct operation of the communication between the Display and the Gateway
- Repeat the operations 1. ⇒ 5. to add more devices

- Procedure for Measure device with pulse output

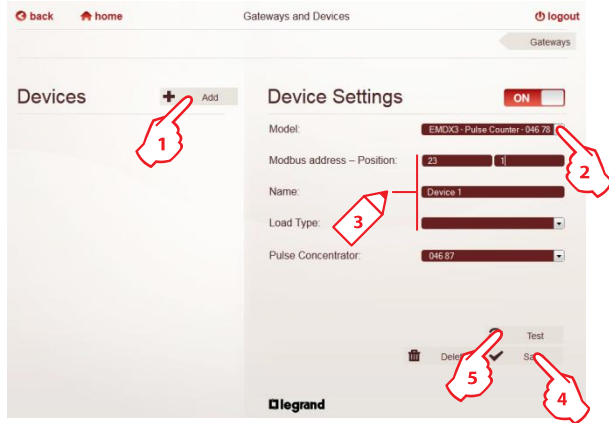

1. Click "Add"
 2. Choose the model from the models list
 3. Assign the Device parameters:
 - Modbus address - Position (required parameters)
 - Name (required parameter)
 - Load type (optional parameter)
 4. Click "Save"
 5. Click "Test" to verify the correct operation of the communication between the Display and the Gateway
- Repeat the operations 1. ⇒ 5. to add more devices

- Details for Pulse output Meters

Position: corresponds to the input number of the Concentrator (Cat. No **046 87**) on which the pulse output of the counter is connected.

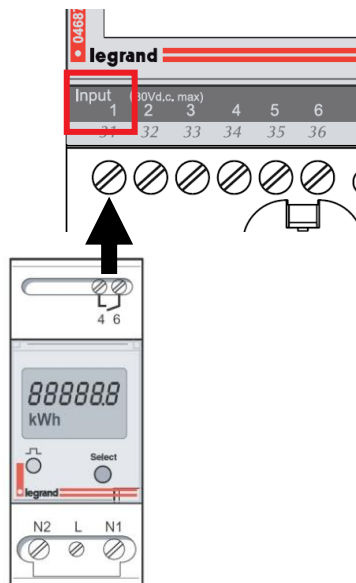

- Procedure for Circuit-breakers DPX³ and DMX³

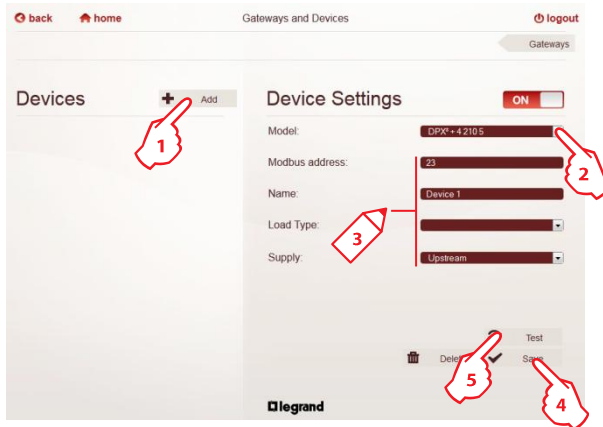

1. Click "Add"
 2. Choose the model from the model list
 3. Assign the Device parameters:
 Modbus address (required parameter)
 Name (required parameter)
 Load type (optional parameter)
 Supply direction of the Circuit-breaker (required parameter)
 4. Click "Save"
 5. Click "Test" to verify the correct operation of the communication between the Display and the Gateway
- Repeat the operations 1. ⇒ 5. to add more devices

- Details for Circuit-breakers DPX³ and DMX³

Supply: to ensure correct measurement of various electrical quantities, it is necessary to indicate the Supply direction of the circuit-breakers:

circuit-breaker supply from the top → choose Upstream (Default setting)









circuit-breaker supply from the bottom → choose Downstream

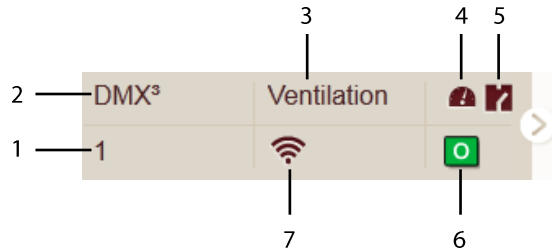

Note: to modify this setting it is necessary to delete and recreate the device.

• Description of the device selection button



1. Modbus address (Modbus Address-Position, for the counters with pulse output)
2. Name of the device
3. Assigned Load
4. Symbol indicates that the device is a measuring / metering instrument
5. Symbol indicates that the device is a protection device (ex. Circuit-breaker)
6. This symbol appears only if the device is a protection device and shows the circuit-breaker state:
 -  Open
 -  Closed
 -  Tripped
7. Communication status
 -  On
 -  Off
 -  Communication error

• **SYSTEM FUNCTIONS**

– ON/OFF Button



Allows to enable/disable a Gateway or a Device; the function is available only for Gateways and Devices.

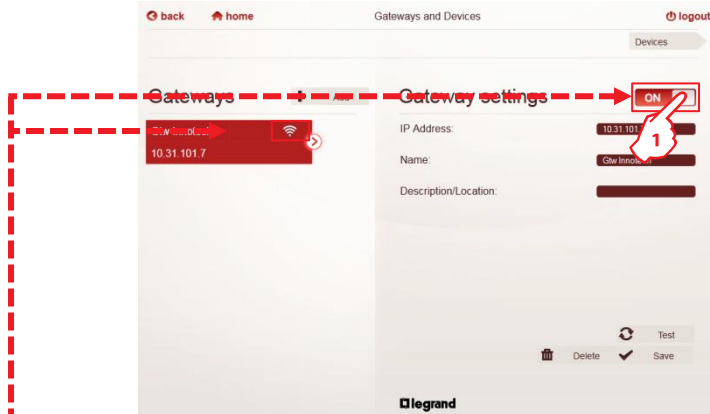

1. Click "ON" to switch off a Gateway / Device

The selected Gateway / Device and the button switch into the OFF state.

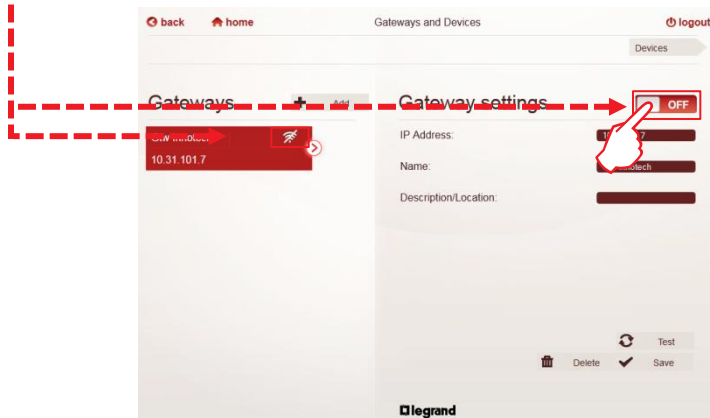

Note:

- The deactivation of a Gateway causes the deactivation of all devices connected to it.
- If a device is turned-off, its measurement data will not be displayed in the "Devices" page.
- To return a Gateway / Device in the ON state, simply click "OFF"

– DELETE Button



Allows to erase a Gateway or a Device.

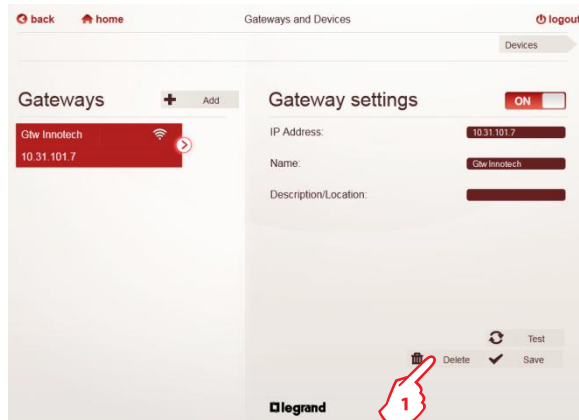

1. Click "Delete"

The selected Gateway / Device is erased.

Note: System it will not ask the confirmation before erasing a Gateway / Device!

• **LIST OF REQUIRED PARAMETERS:**

- Highly required parameters - Address/Position:
 - ✓ Modbus Address, a different Modbus address for each device connected to the same bus RS485
 - ✓ Positions, different for wiring reasons (only for Counters with pulse output)
- Essential parameter – Name:
 - ✓ Impossible to use several times the same name
 - ✓ If forgotten during the settings, Display will assign a default value (IP Address for Gateway, Modbus Address for Devices RS485, Modbus Address-Position for Devices with pulse output)
- Useful parameter – Model:
 - ✓ Possibility to have one, two or several identical models.
 - ✓ If forgotten during the settings is shown the message "Configuration Error".

4.10.2 Loads configuration

Optional setup, used to give a description of the electrical installation by load(s)

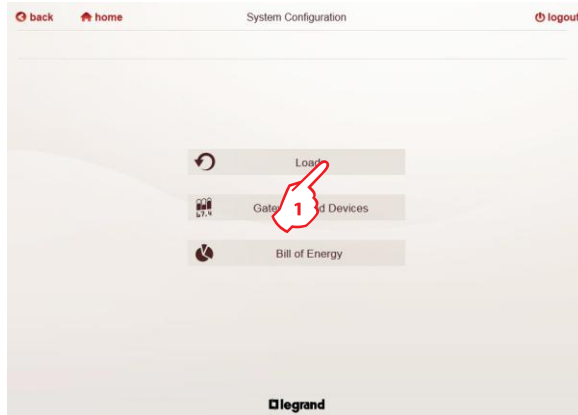

1. Click "Loads"

Loads settings page appears

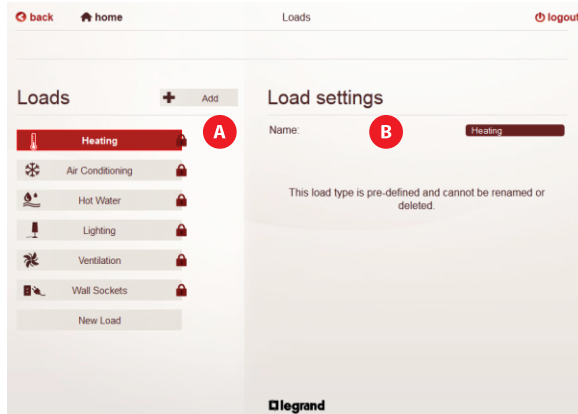

The page is divided into two sections:

section **A** is the "Pre-defined and Added Loads" area.

section **B** shows the "Loads Settings" area, where the configuration fields for the selected Load are available (only for user creatable loads).

• CREATING AND SAVING A LOAD

For a distribution of the devices according to the type of load.

Are available:

- 6 "pre-defined" categories (heating, air conditioning, etc.)
- Category "Others" to display the measurement without Load assigned
- 8 additional categories, user-creatable

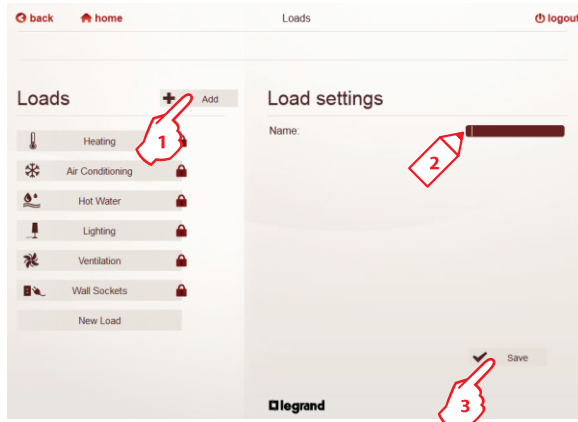

To create a Load:

1. Click "Add"
2. Assign the load parameter:
Name (required parameter)
3. Click "Save"

Repeat the operations 1. ⇒ 3. to add more loads

Note: it is possible to have a maximum of 14 loads.

• ASSIGNMENT OF LOADS

Return to the section "Gateways and Devices" in "System configuration".

In the Device settings area of the Devices page, is possible to assign a Load to each Device previously created.

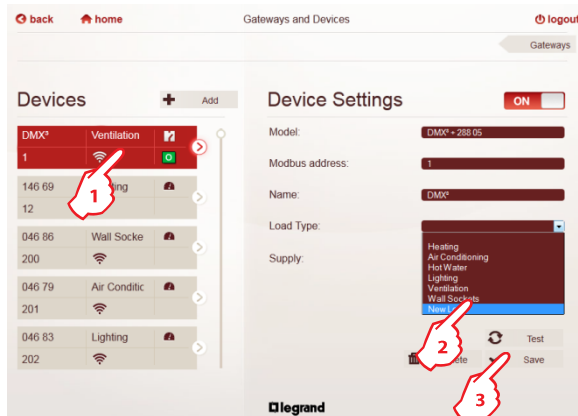

1. Choose a Device
2. Choose a Load from the Loads list
3. Click "Save"

• **SYSTEM FUNCTIONS**

– DELETE Button



Allows to disable / erase a Load.

Note: This operation is available only for the loads created by the user.

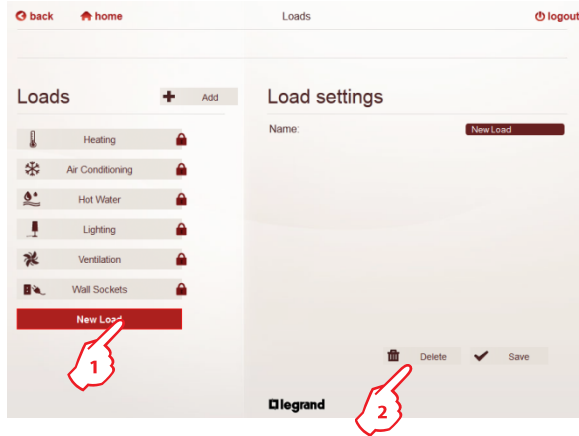

In the Loads settings page

1. Choose a Load
2. Click "Delete"

An intermediate page in which, the deactivation (Disable) or the erasing (Erase) of the selected Load is proposed.

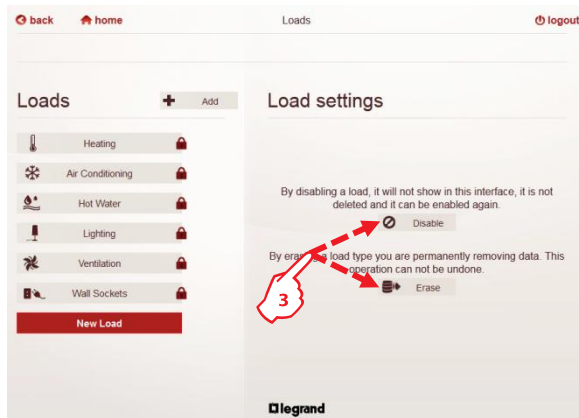

3. Click "Disable" to deactivate the Load or "Erase" to remove definitively the Load.

By clicking on "Disable" the selected load goes into "Deactivated" state.

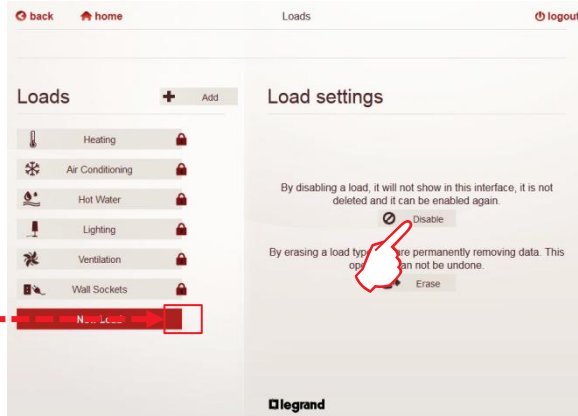

This state is indicated by the symbol  near the Load name.

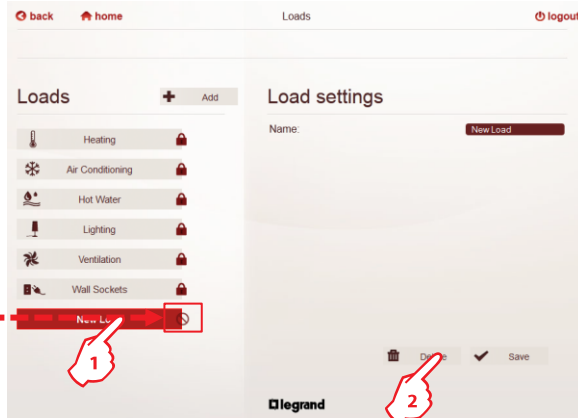

To enable a Load,:

1. Click on a load button
2. Click "Delete"

An intermediate page appears:

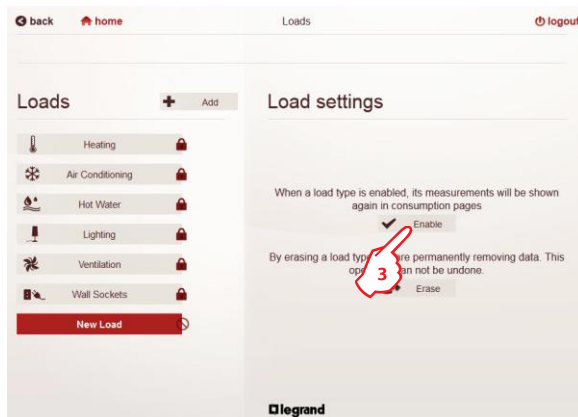

3. Click "Enable"

4.10.3 Bill of Energy configuration

Optional setting, allows the economic accounting of energy consumption

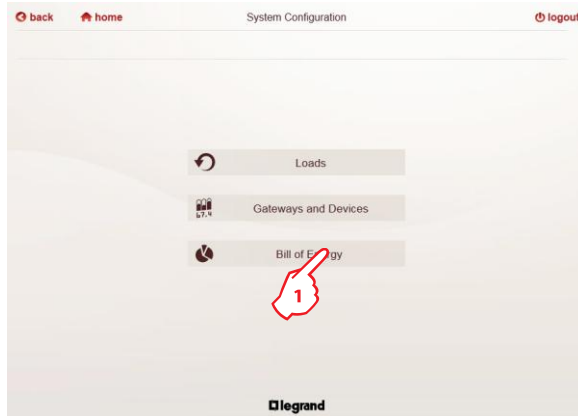

1. Click "Bill of energy"

The Bill of Energy setting page appears

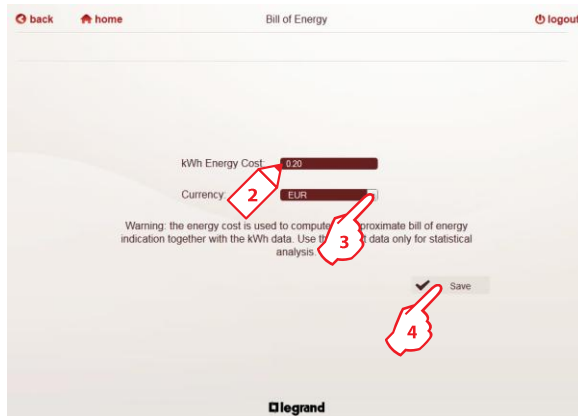

2. Assign the average kWh energy price

3. Choose the Currency

4. Click "Save"

IMPORTANT: the cost of energy is approximate, usable for statistical purposes only.

5. Use

5.1 Access

The access to the Panel Board Display's data is protected by an identification code (PIN code).

Three types of "default" users are configured:

- "Administrator"
- "Installer"
- "User"

5.1.1 Access rights

- "Administrator"

Access to the pages:

- Display configuration
- System configuration
- Devices

Default access code (PIN):

- 99999 (5 characters)

- "Installer"

Access to the pages:

- System configuration
- Devices.

Default access code (PIN):

- 55555 (5 characters)

- "User"

Access to the pages:

- Devices.

Default access code (PIN):

- 11111 (5 characters)

5.1.2 Creating a new User

Only the user **Administrator** can add new users.

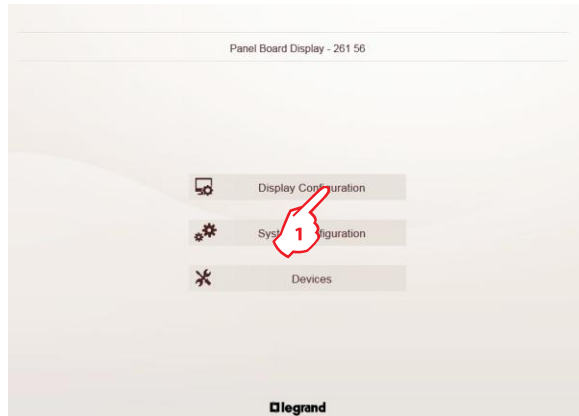

1. Click "Display configuration"

Login page appears

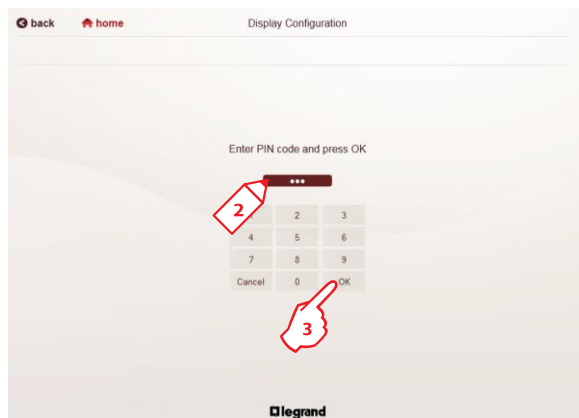

2. Type the access PIN code 99999

3. Click "OK"

Panel Board Display's configuration page appears

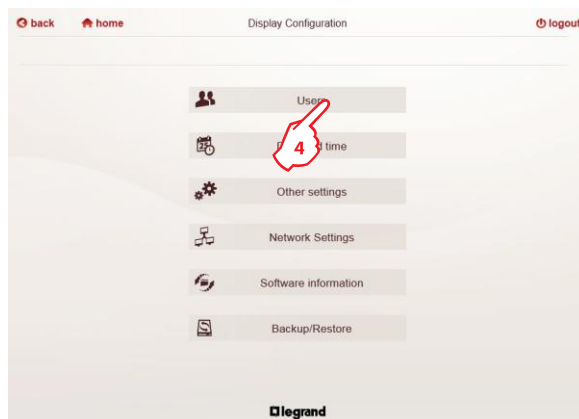

4. Click "Users"

Users configuration page appears

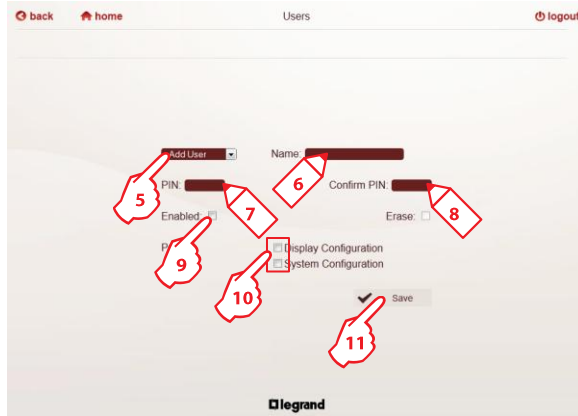

5. Choose from the list "Add User".
6. Assign a name to the new user.
- 7-8. Type the PIN code for the new user and confirm it.
9. Click to enable the new user.
10. Choose which pages the new user can see.
11. Click "Save"

5.1.3 Changing of the access rights

The access rights of a user can be modified only by the **"Administrator"**

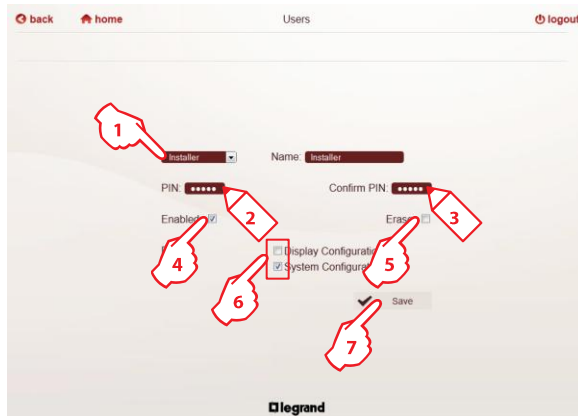

In the Users configuration page

1. Choose from the list "name of a user" (ex. Installer) to edit it.
- 2.-3. Type the PIN code for the user to edit and confirm it.
- 4.-5. These two options allow to disable a user without erase it (4.) or to erase definitively a selected user (5.) once the "Save" button is clicked.
6. Choose, for the user to edit, which pages it can see.
7. Click "Save".

5.1.4 Logout procedure

The symbol  **logout** appears on all pages, once a user has logged into a page where the PIN code is required (Display configuration and System configuration).

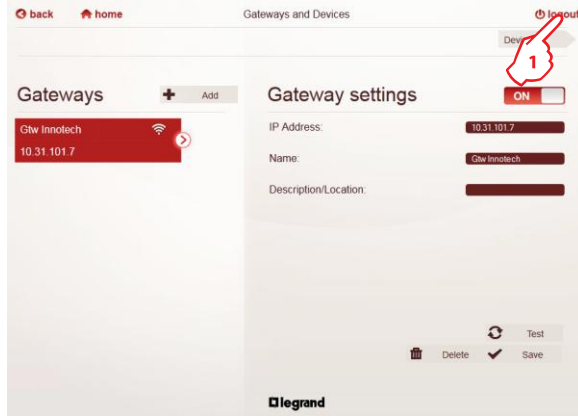

1. Click "logout"

The procedure returns the user to the Home page of the device whatever is the visualized page.

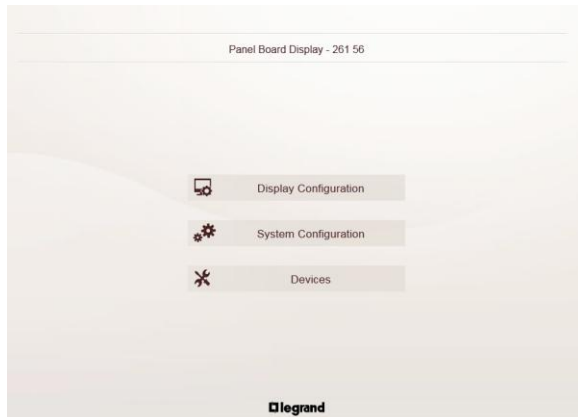

5.2 Data display pages

5.2.1 Devices

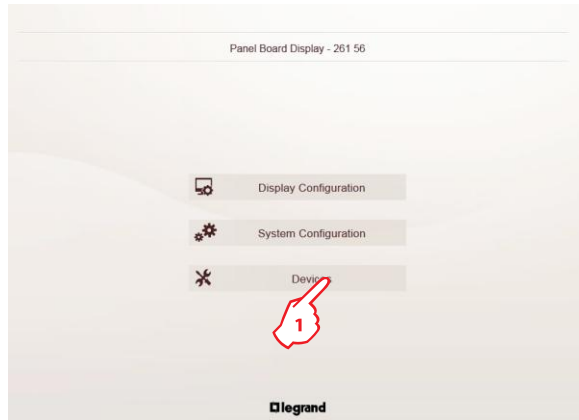

In the Home Page

1. Click “Devices”

Devices page appears

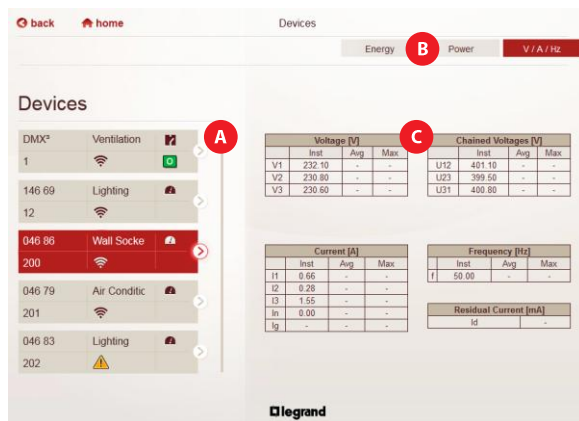

The page is divided into three sections:

section **A** shows the devices added by the users with their characteristics and status icons





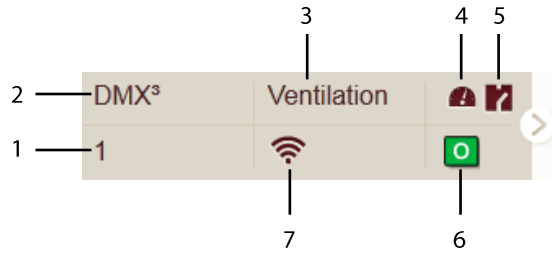

section **B** is the area where is possible to select the various electrical quantities to be displayed:

- Energy
- Power
- Voltages / Currents / Frequency
- THD (if available on the Device)
- Harmonics (if available on the Device)

section **C** shows the values measured by the selected device

• Description of the device selection button



1. Modbus address (Modbus Address-Position, for the counters with pulse output)
2. Name of the device
3. Assigned Load
4. Symbol indicates that the device is a measuring / metering instrument
5. Symbol indicates that the device is a protection device (ex. Circuit-breaker)
6. This symbol appears only if the device is a protection device and shows the circuit-breaker state:
 -  Open
 -  Closed
 -  Tripped
7. Communication status
 -  On
 -  Off
 -  Communication error

6. Backup and Restore

These procedures are used to create a backup of the device configuration and to perform the restore of a saved configuration

6.1 Backup procedure

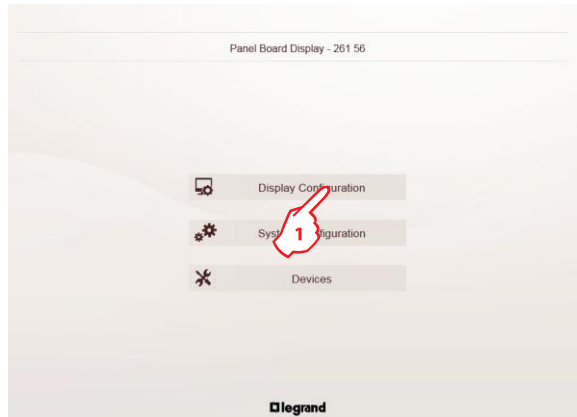

In the Panel Board Display's home page

1. Click "Display configuration"

Note: If a user is already logged-in, the device doesn't ask the PIN. Otherwise if no user is logged-in, the login page appears and is necessary perform the access typing the PIN code.

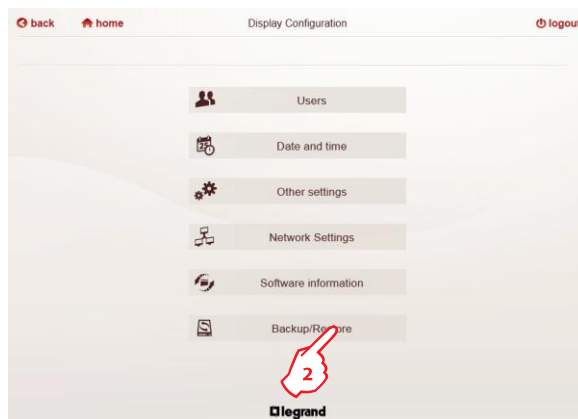

In the Display configuration page

2. Click "Backup/Restore"

Backup and restore page appears

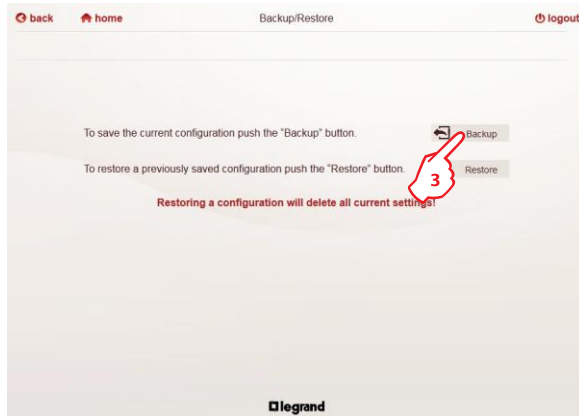

3. Click "Backup" to access the page

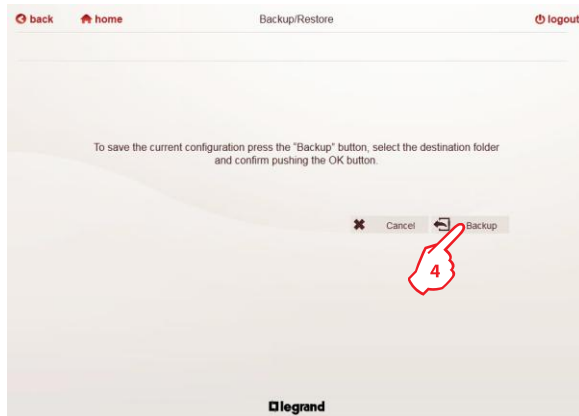

4. Click "Backup" to perform the function.

The device ask you to save on your PC a file called "conf.xml"

Note: not modify the file's name and its contents to avoid problems during the restore procedure!

6.2 Restore procedure

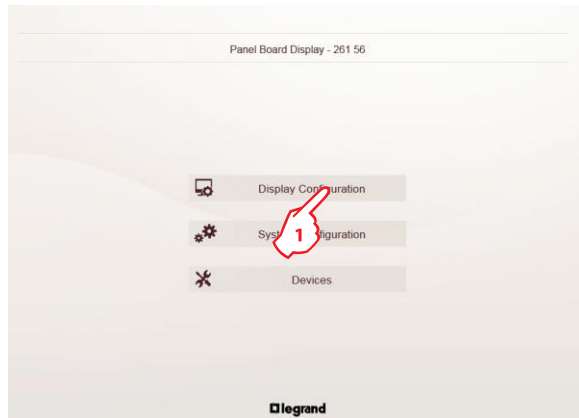

In the Panel Board display's home page

1. Click "Display configuration"

Note: If a user is already logged-in, the device doesn't ask the PIN. Otherwise if no user is logged-in, the login page appears and is necessary perform the access typing the PIN code.

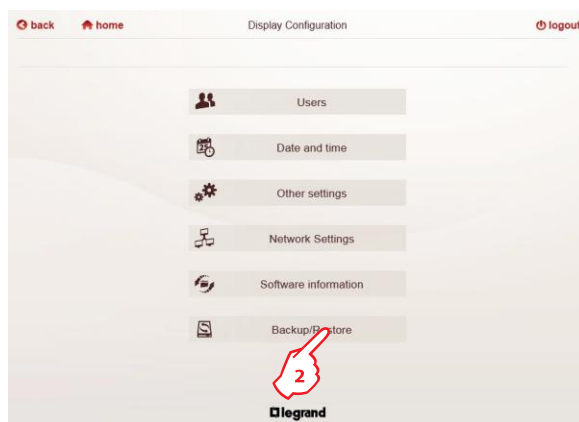

In the Display configuration page

2. Click "Backup/Restore"

Backup and restore page appears

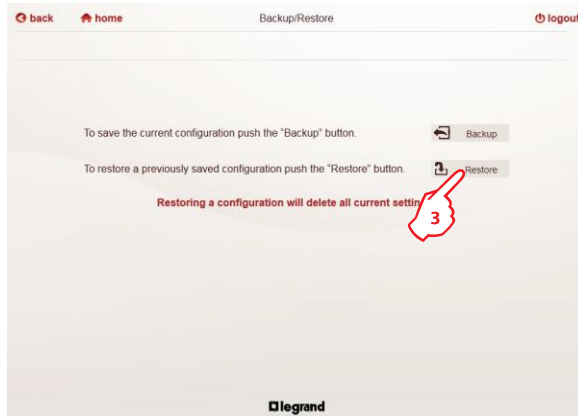

3. Click "Restore" to access the page

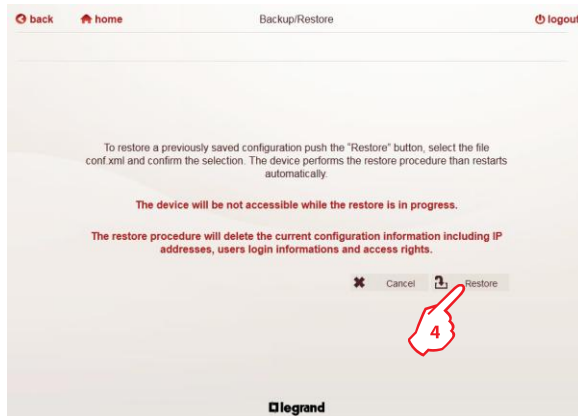

4. Click "Restore" to perform the function

The device ask you to load from your PC the file "conf.xml".

Select the file and confirm the selection.

Note:

- Restore procedure keeps few minutes.
- The good result of the operation will be guaranteed only if the file has not been modified after the backup (names, contents etc..)
- Device perform the restore procedure than restart automatically.

7. Network type and access mode

7.1 LAN/Intranet

Private network

Addresses and rights managed by the Manager of the Building

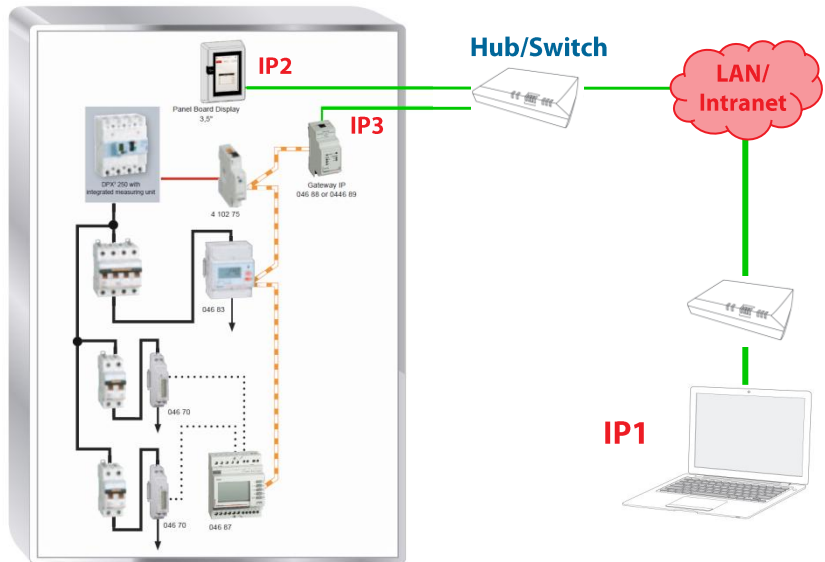

7.1.1 Ports

- Panel Board Display to Gateway:
 - Port 502, Modbus TCP

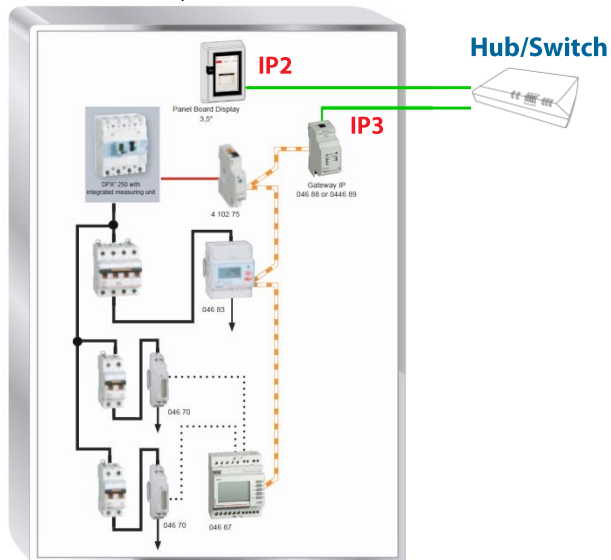

- Users to Panel Board Display:
 - Port 80, HTTP (<http://IP2> by web browser)

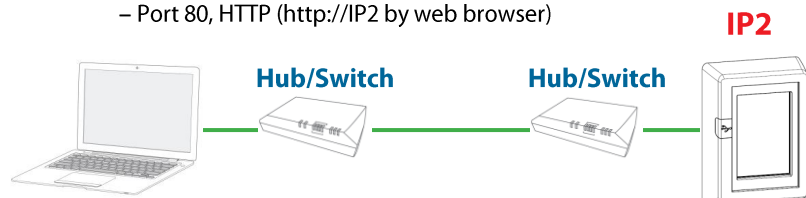

7.2 WAN/Internet

Public network

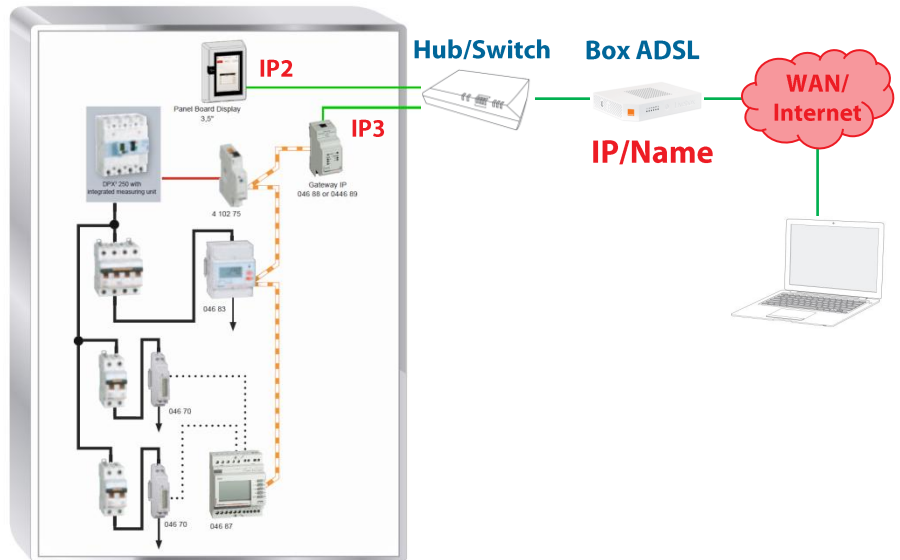

Fixed* IP Box: the IP address remains the same

⇒ Access by IP address (Fixed IP paying according to the operators)

Dynamic* IP Box : the address may change

⇒ Access by Name (possibility of creating a dynamic DNS account – Example www.dyndns.org)

- **User:** access by the public address of the Box (**IP/Name**, Internet)
- **Panel Board Display:** always has a fixed private address (**IP2**, Intranet)

⇒ It is necessary to achieve the association Display/Box*

* More information from the ADSL operator

7.2.1 Ports

- Panel Board Display to Gateway:
 - Port 502, Modbus TCP

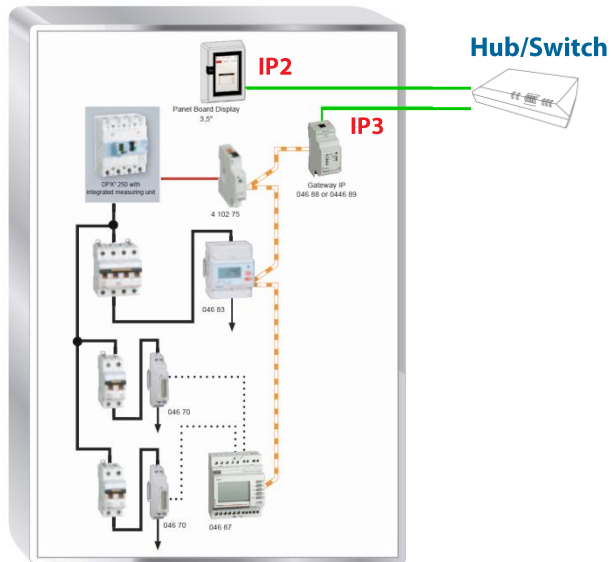

- Users to Panel Board Display:
 - Port 80, HTTP (http://IP2 by web browser)

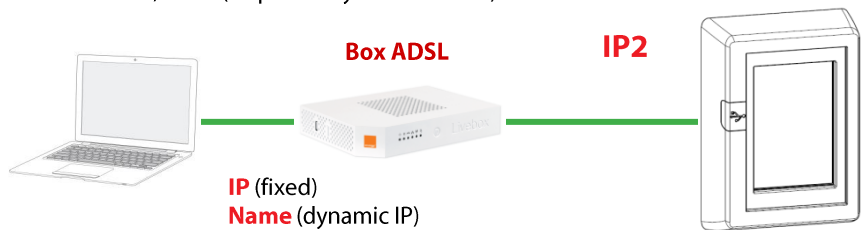



World Headquarters and
International Department
87045 LIMOGES CEDEX FRANCE

☎: 33 5 55 06 87 87

Fax : 33 5 55 06 74 55

www.legrandelectric.com