

6 051 53

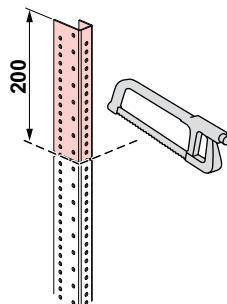

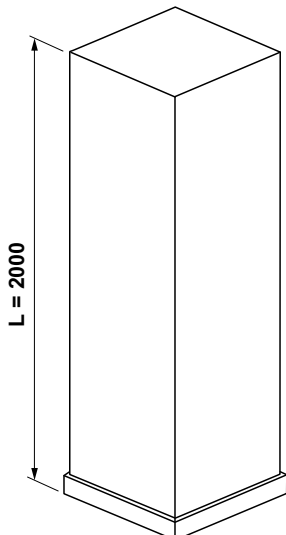

0 205 22/23

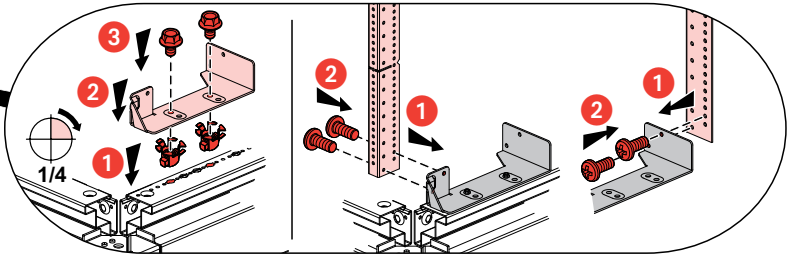
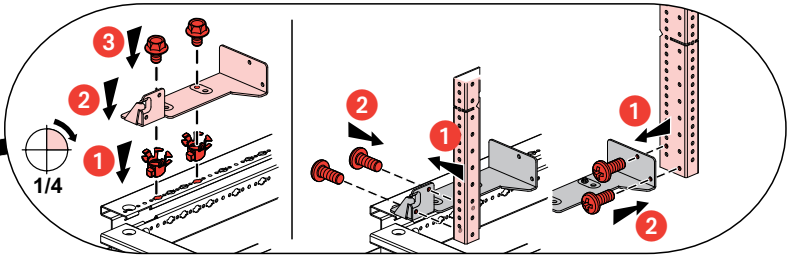
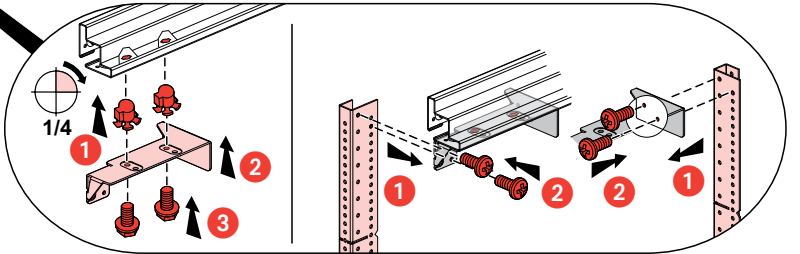
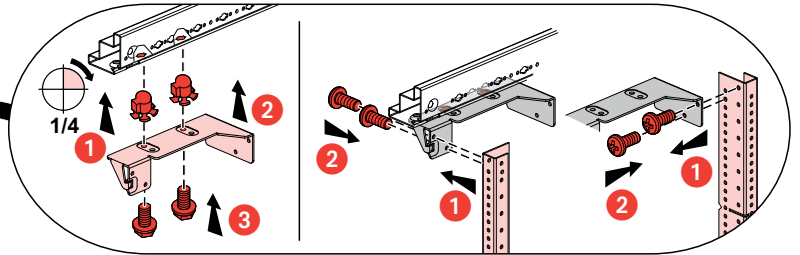
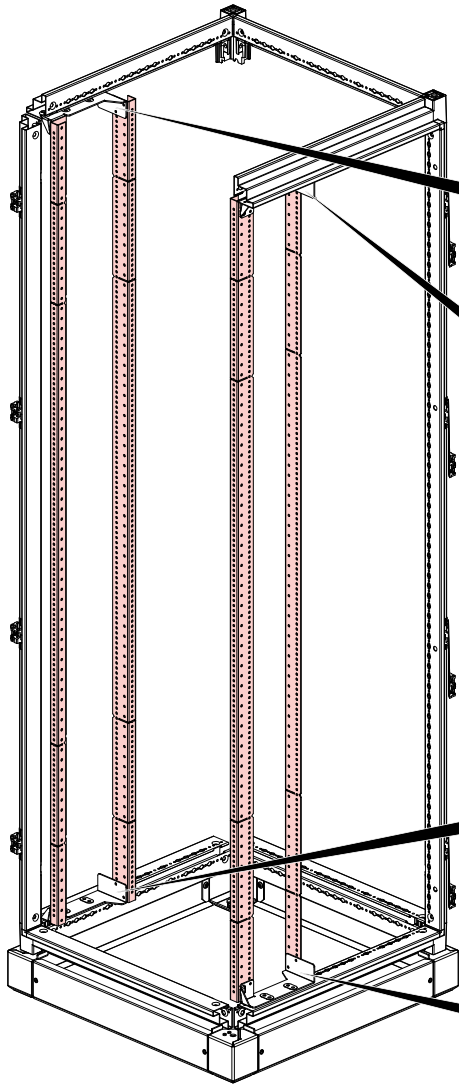
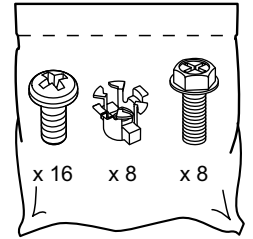
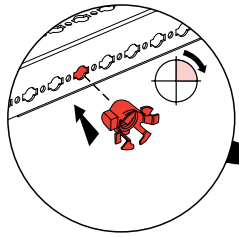
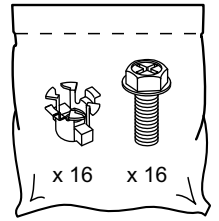
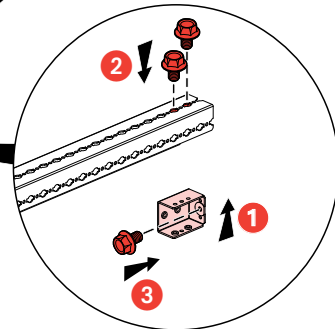
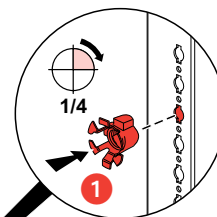
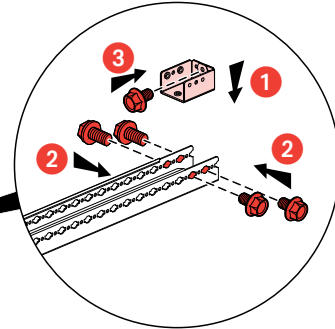
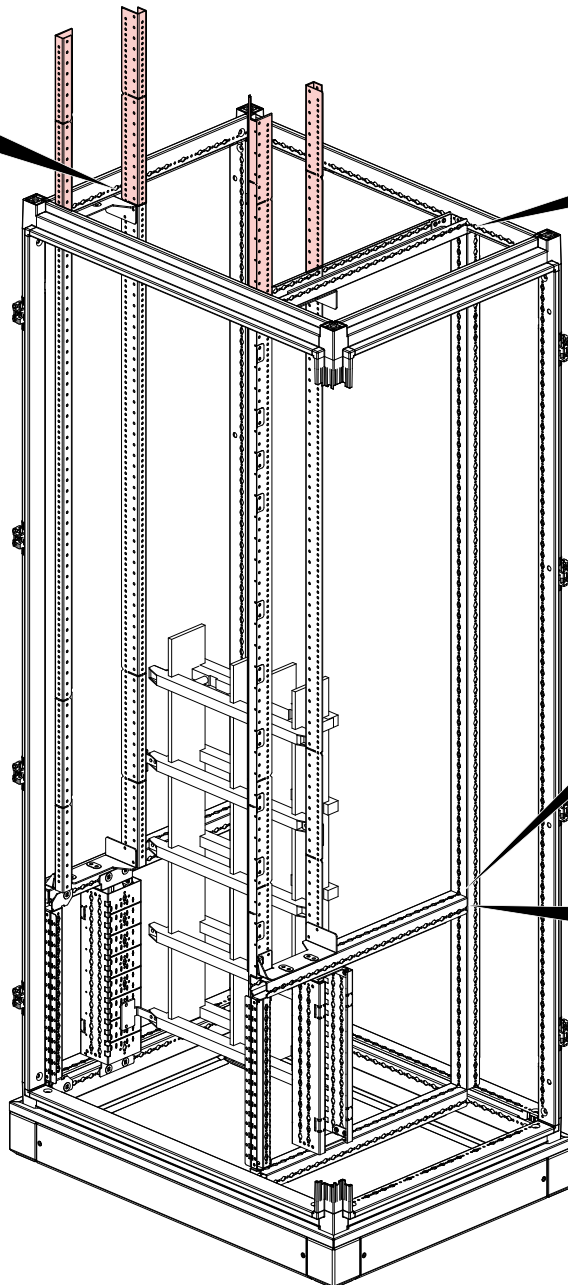
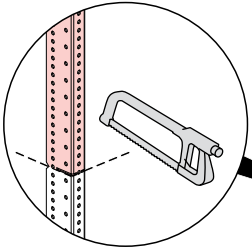
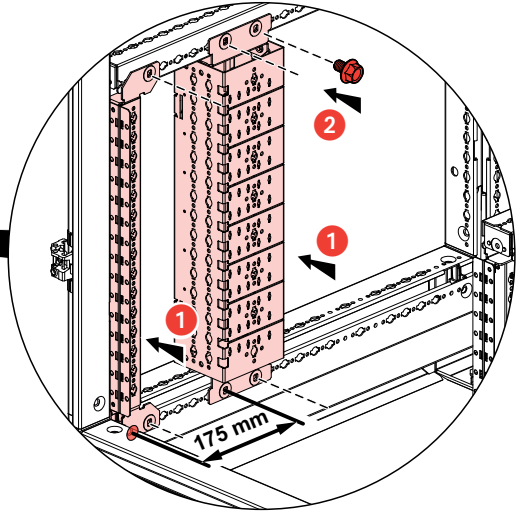
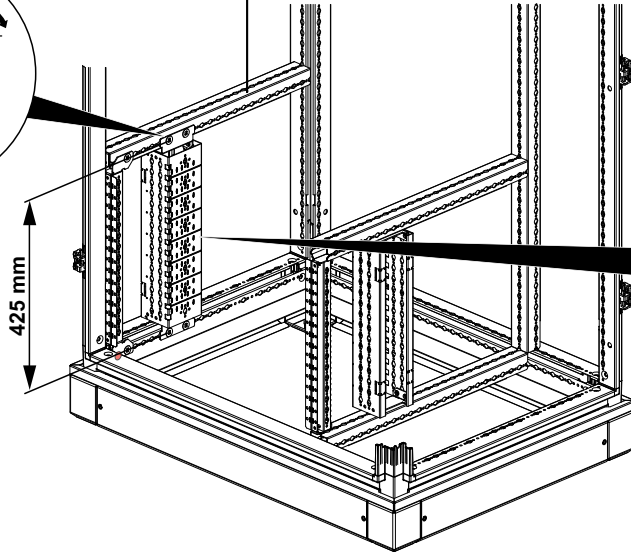

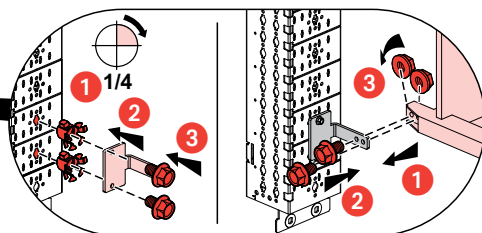
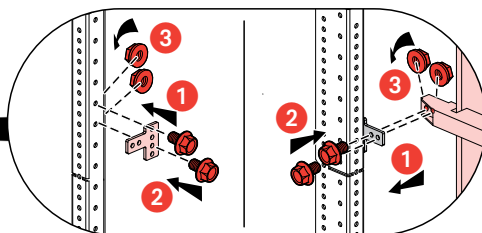
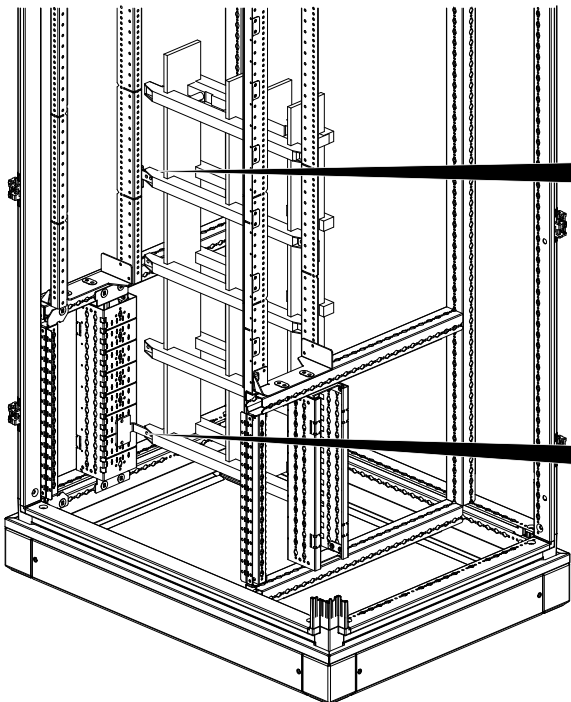
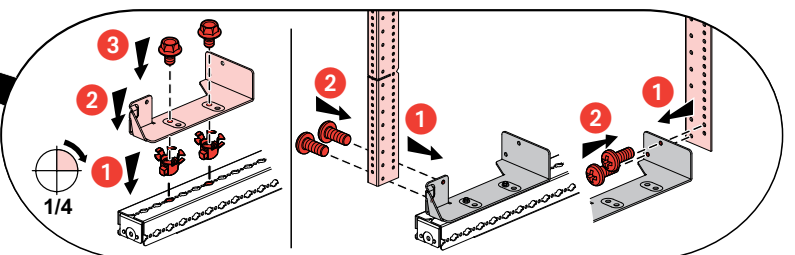
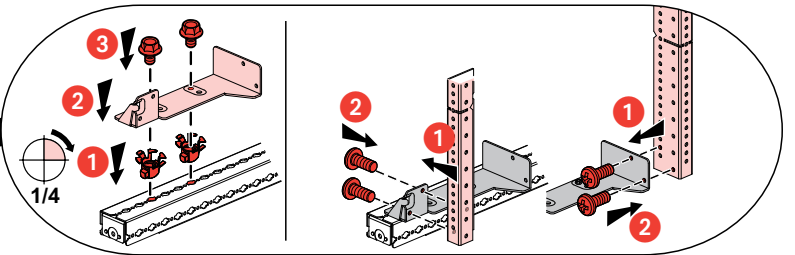
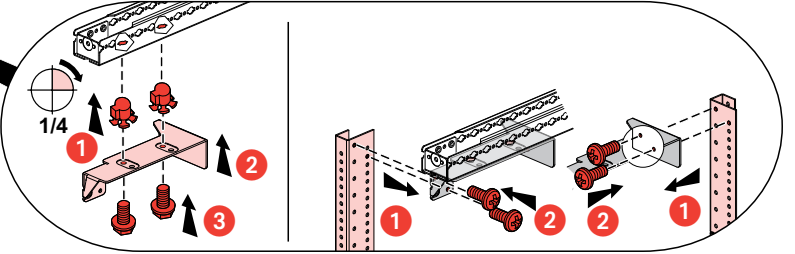
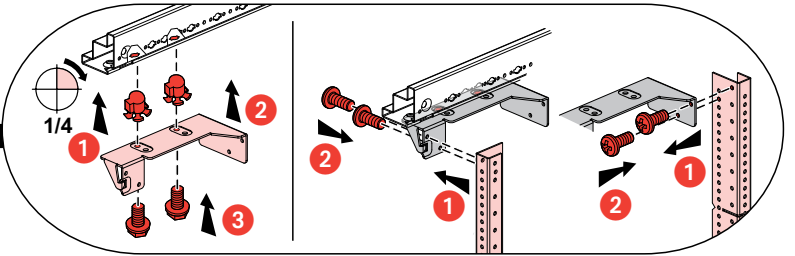
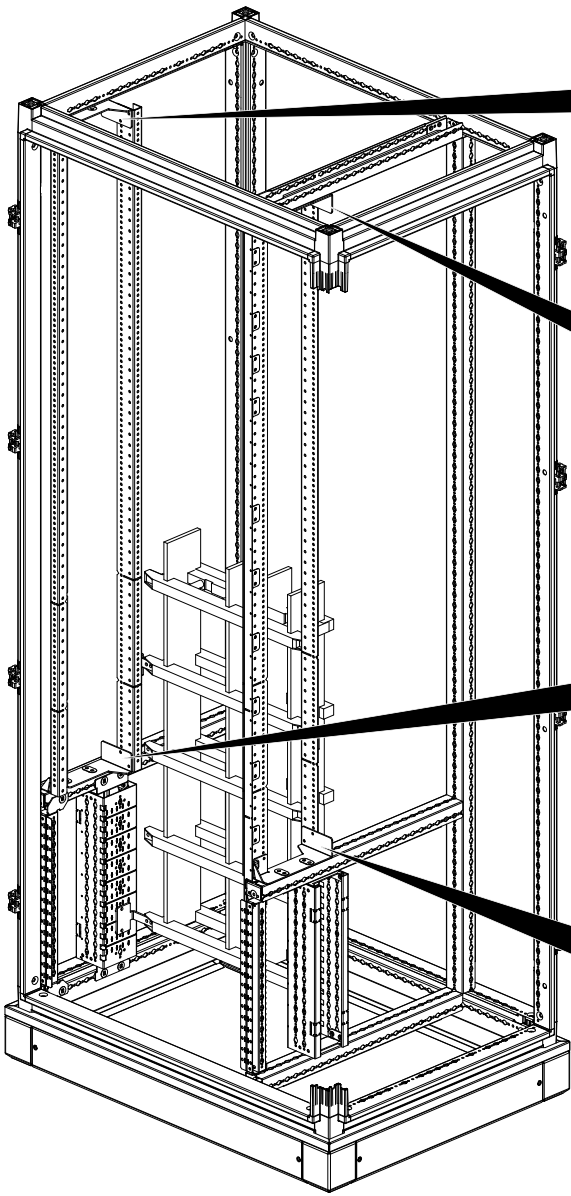

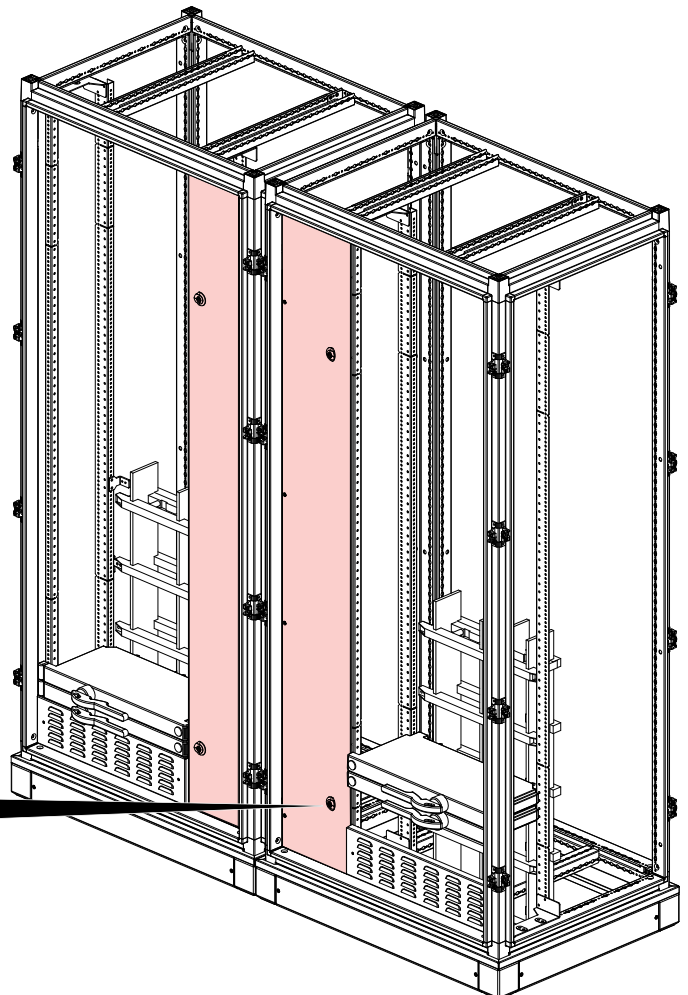
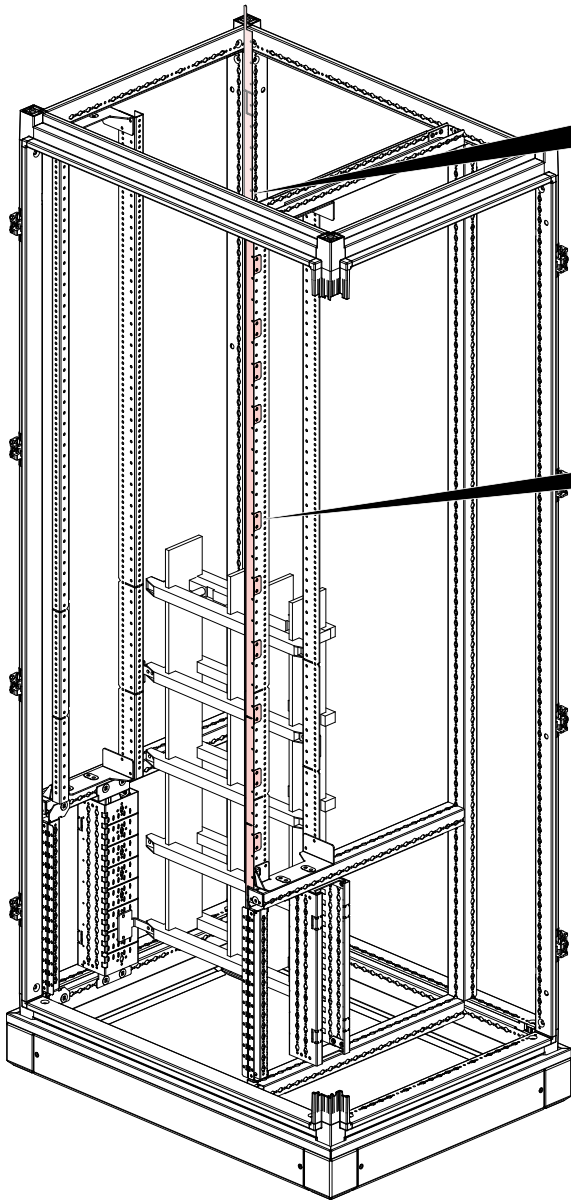
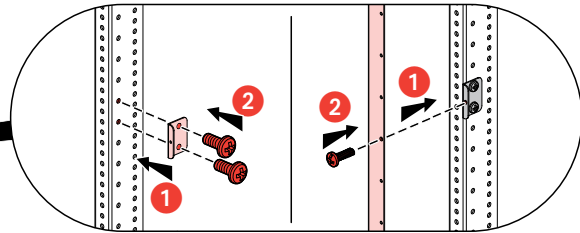
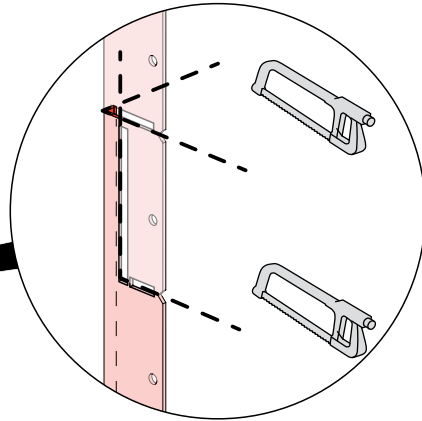
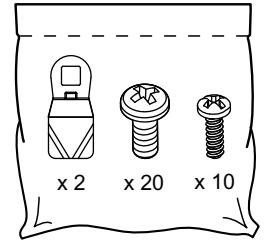

	✓	—
	—	✓