

Incara™ Disq 60

Cat. No(s): 6 547 20/21/22/23/25/26/27/28/30/31/32/33/39/99
6 547 20F/21F/22F/23F/25F/26F/27F/28F/30F/31F/32F/33F
6 550 00/01/02/03/04/05/06/07/08/09/10/11/12/13/14 - 6 549 86/87/88/89

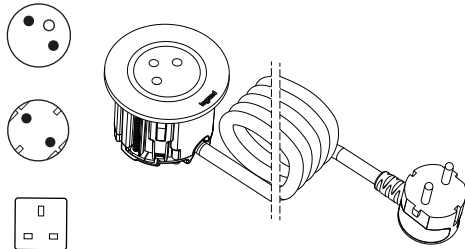

6 547 20/21/22

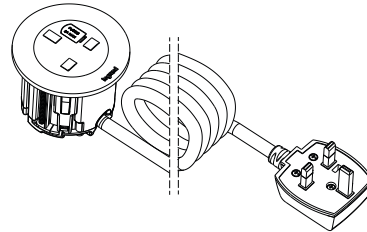

6 555 00/01/02

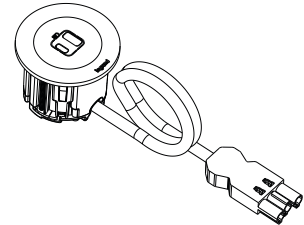

6 547 30F/ 31F/32F

1. USE

Desk, partition, soft seating or locker, Incara™ Disq 60 adapts to any environment to provide power socket or USB charger A+C 15W, as close to the user as possible. Available in white, black, metal or with a cover, Incara™ Disq 60 is an aesthetic and discreet solution that is quick and easy to install.

2. RANGE

■ 2.1 French & Schuko standards

Incara™ Disq 60 equipped with	Standards	2 m cord with 2 P+E plug				0.5 m cord with Wieland® plug GST18i3			
		White*	Black*	Metal*	Metal cover	White*	Black*	Metal*	Metal cover
1x 2P+E	French	6 547 20	6 547 21	6 547 22	6 547 23	6 547 20F	6 547 21F	6 547 22F	6 547 23F
	Schuko	6 547 25	6 547 26	6 547 27	6 547 28	6 547 25F	6 547 26F	6 547 27F	6 547 28F
		2 m cord with 2 P plug				0.5 m cord with Wieland® plug GST18i3			
1 USB A+C 15W	-	6 547 30	6 547 31	6 547 32	6 547 33	6 547 30F	6 547 31 F	6 547 32F	6 547 33F

* Ring finishes (4 additionnal colours available on demand)

■ 2.2 British standard

Incara™ Disq 60 equipped with	2 m cord with Intersoc R plug			2 m cord with plug BS1363			0.5 m cord with Wieland plug GST18i3		
	White*	Black*	Metal*	White*	Black*	Metal*	White*	Black*	Metal*
1x 2P+E	6 550 03	6 550 04	6 550 05	6 550 00	6 550 01	6 550 02	6 550 06	6 550 07	6 550 08
1 USB A+C	6 550 09	6 550 10	6 550 11	6 550 12	6 550 13	6 550 14	6 54730 F	6 547 31F	6 547 32F

* Ring finishes (4 additionnal colours available on demand)

3. DIMENSIONS

■ 3.1 Incara™ Disq 60 with ring

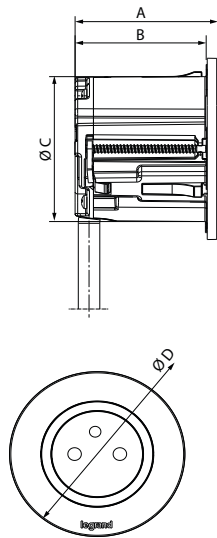

Cat. nos	A	B	C	D
6 547 20/21/22/20F/21F/22F/25/26/27/ 25F/26F/27F/30/31/32/30F/31F/3 2F - 6 550 00/01/02/03/04/05/06/ 07/08/09/10/11/12/13/14	54.5	50	59	74

■ 3.2 Incara™ Disq 60 with cover

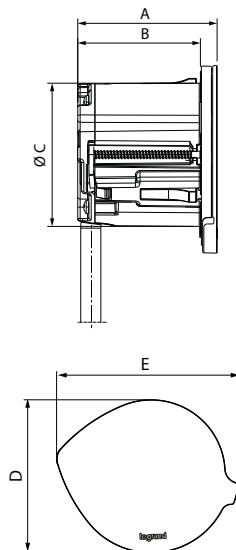

Cat. nos	A	B	C	D	E
6 547 23/23F/33/33F	57	50	59	77	91

4. INSTALLATION

Must not be fitted on the floor.

■ 4.1 Into the desk

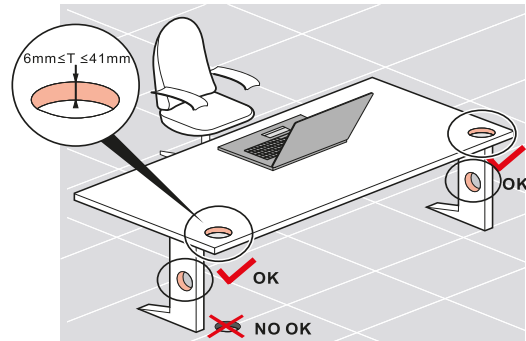

4.1.1 Drilling dimensions and positioning

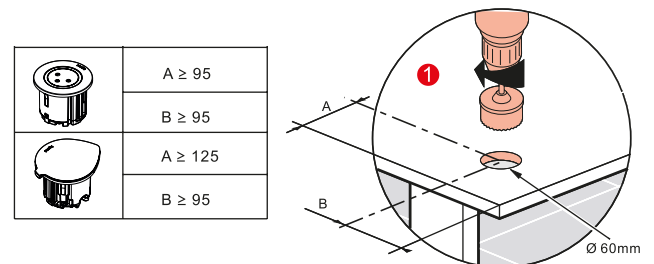

4.1.2 Insertion

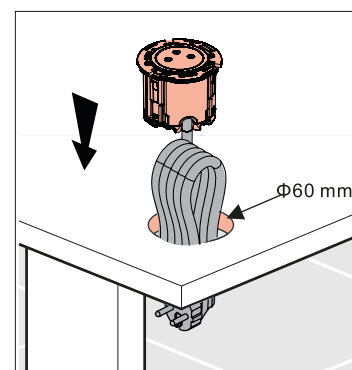

4. INSTALLATION (cont.)

■ **4.2 Into metal furniture such as metal locker**

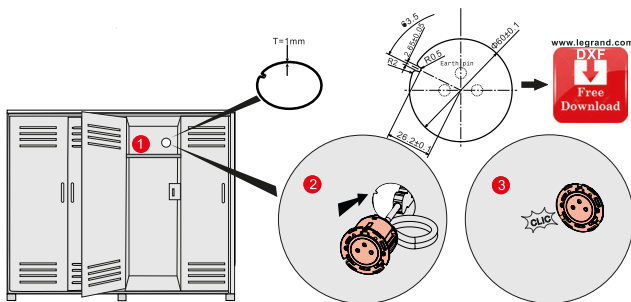

Metal = 1 mm max

■ **4.3 Into soft seating**

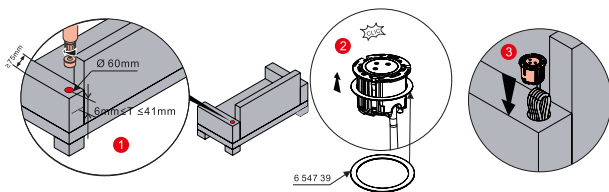

Use of the accessory cat. no 6 547 39, necessary to ensure a good fit of the product in the seating covering.
Use of products with cover is not recommended for this type of installation.

■ **4.4 Ring/cover installation**

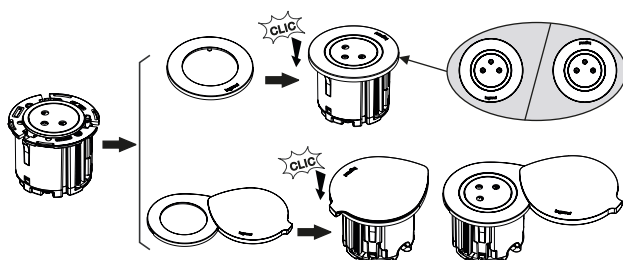

5. TECHNICAL CHARACTERISTICS

■ **5.1 Mechanical characteristics**

Resistance to impact: IK 07

■ **5.2 Material characteristics**

Metal ring and cover: brushed aluminum and varnish
Black & white ring and housing: Polycarbonate UL94V0

■ **5.3 Electrical characteristics**

5.3.1 2 P+E sockets characteristics

- Supply voltage: 250V~
- Frequency: 50/60 Hz
- Rated current:
 - . for French & Schuko standards = 16A
 - . for British standard : individually fused = 5A

5.3.2 USB Charger characteristics (LXX15)

Trade mark	
Address	128, av. du Maréchal-de-Lattre-de-Tassigny - 87045 LIMOGES Cedex Tel. : 0 (+33) 5 55 06 87 87 Fax : 0 (+33) 5 55 06 88 88 www.legrand.com
Input voltage	110-240V
Input AC frequency	50-60Hz
Output voltage	5,0V
Output current	3,0A
Output power	15,0W
Average active efficiency	83,9%
Efficiency at low load (10%)	83,3%
No-load power consumption	0,06W

5.3.3 Cords characteristics

Cable type	Cat. nos
H05VV-F 3G 1.5mm ²	6 547 20/21/22/23 6 547 20F/21F/22F/23F 6 549 86/87
H05VVH2-F 2x0.75mm ²	6 547 30/31/32/33
H05VV-F 2x1mm ²	6 547 30F/31F/32F/33F

■ **5.4 Climate characteristics**

Operating temperature: from -5°C to +35°C
Storage temperature: from -10°C to +70°C

6. CLEANING

Superficial cleaning with a soft cloth. Do not use abrasive products or detergents

Caution: Always test before using other special cleaning products

7. STANDARDS & APPROVALS

Compliant to:

Standards			
French	Schuko	British	
		socket	complete product
NF C61-314 and IEC 60884-1	IEC 60884-1	BS 1363-2	BS 5733

USB charger compliant to IEC 62368-1

Products should be installed by competent persons to the current version of the local wiring regulations.

Please consult Legrand locally for further details.

8. ACCESSORIES

■ 8.1 Extension cords cat. nos 6 549 86/87/88/89

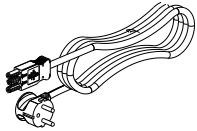
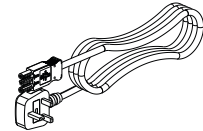
Cat. nos	Wieland GT18i3 cord		
6 549 86	2 P+E plug	2 m	
6 549 87		3 m	
6 549 88	BS plug	2 m	
6 549 89		3 m	

8. ACCESSORIES (cont.)

■ 8.2 Protective case for Wieland® GST18i3 connector cat. no 6 547 99

for cat. nos
6 547 20F/21F/22F/25F/26F/27F/30F/31F/32F/6 550 06/07/08

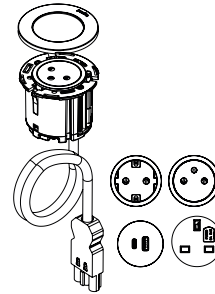

Protective case allowing compliance with NFC 61-314 standard, which requires an housing covering the installation couplers. Access for connection or disconnection of these couplers must be possible only using a tool (e.g. screwdriver).

