

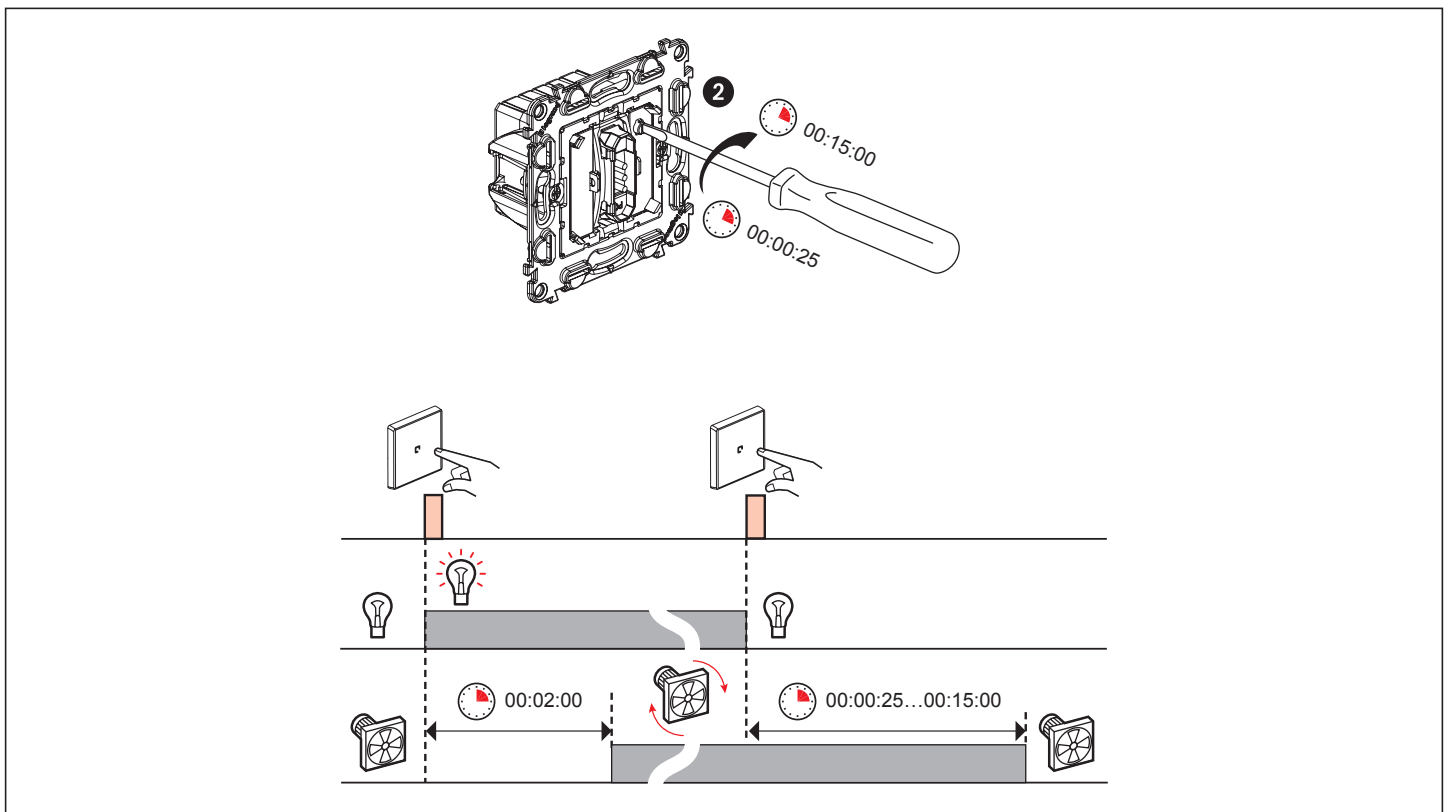

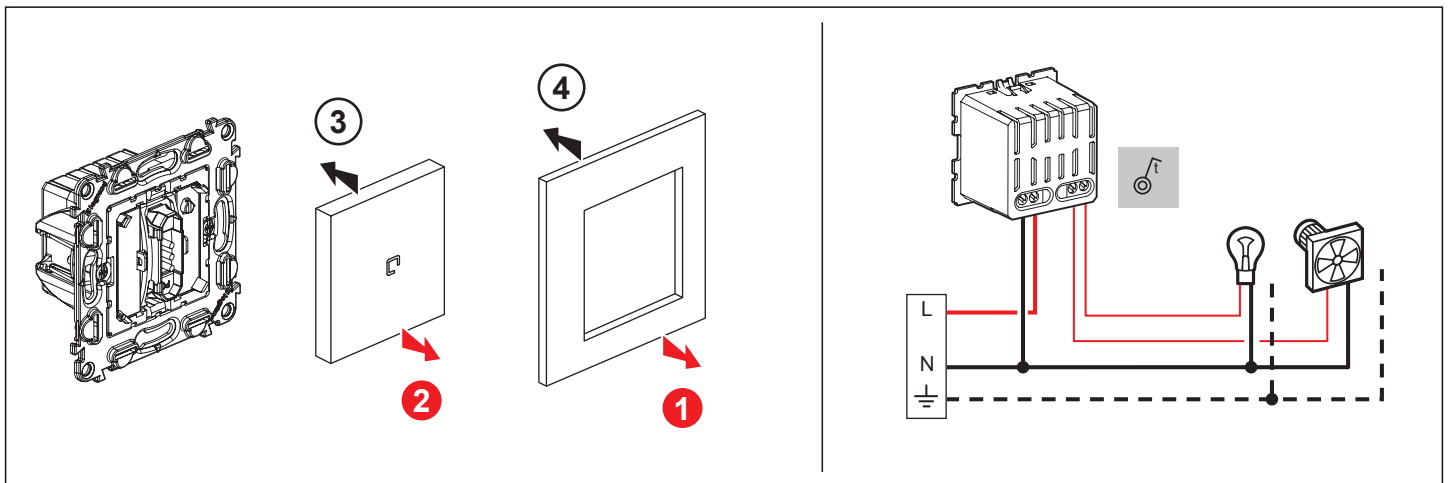

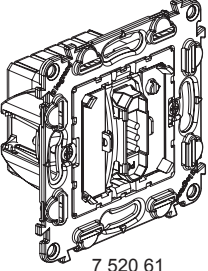









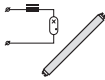
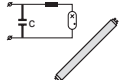

<p>7 520 32</p>					
	-5°C ... +50°C	-5°C ... +50°C*	40 mm	00:00:25 ... 00:15:00	<p>6 mm 1...2,5 mm²</p>

2x 1A cos φ = 1 250V~	250W	250 VA	2x 58W 14μF	250W	100W	250 VA	250 VA	250 VA

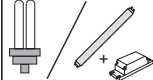

 <p>7 520 61</p>					
	-5°C ... +50°C	-5°C ... +50°C	40 mm	 00:00:25 ... 00:15:00	 6 mm 1...2,5 mm²

								
8A cos φ = 1 250V~	1840W	400 VA	2x 58W 14μF	1000W	400W	400 VA	400 VA	250 VA

