

**Niloé™**  
**Controls**

Cat. No(s): 6 643 01 - 6 645 03 - 6 647 01/02/04/05/08/09/10/11/13/14/15/26/91  
 6 648 01/02/05/08/09/10/11/13/14

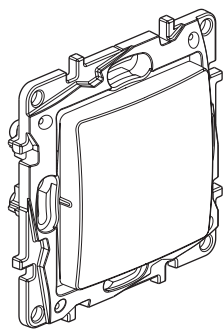

6 647 01 - 6 648 01

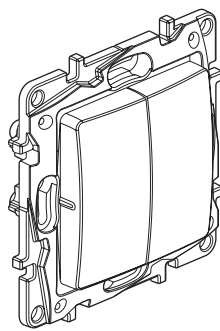

6 647 02 - 6 648 02

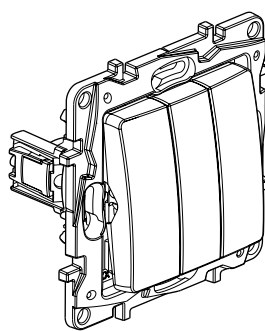

6 645 03

CONTENTS	Pages
1. Use .....	1
2. Range .....	1-2
3. Overall dimensions.....	2
4. Connexion.....	2
5. Technical characteristics.....	3
6. Maintenance.....	3
7. Accessories .....	3
8. Standards and approvals .....	3

**1. USE**

Switch or two-way switch. Double two-way switch with or without indicator. Triple switch, intermediate switch, pushbutton, multifunction controls, roller blind.

The mechanisms are supplied with rockers and support frames. To be fitted with one-gang or multi-gang plates, colour White or Ivory.

Flush or surface-mounting.

Screw or screw and claw mounting with claws (see accessories).

Supplied with protection cover.

**2. RANGE**

**10 AX switches and two-way switches - 250 V~**

	Description	Pur	Lin
	Two-way switch 3 terminals, either switch function or two-way switch.	6 643 01	-
		6 647 01	6 648 01
	Double two-way switch 2 x 3 terminals, either switch function or two-way switch.	6 647 02	6 648 02
	Two-way switch with indicator Becomes illuminated with lamps Cat. No. 6 650 90 or Cat. No. 6 650 92 and monitor with lamp Cat. No. 6 650 91.	6 647 10	6 648 10
	Triple switch 3 x 1-gang switches with fixing claws	6 645 03	-
	Intermediate switch Enables a third control point to be added in a two-way switch installation.	6 647 04	-

**Multifunction switches**





	1 gang multifunction switch Supplied in push-button mode with wide rocker plate fitted. Possible configurations: pushbutton, two-way switch, double pushbutton, double two-way switch, pushbutton + two-way switch, two-way switch + push-button (supplied with 2 half rocker plates for combined functions).	6 647 13	6 648 13
	2 gang illuminated multifunction switch Supplied in 2 gang push-button mode. Can be converted to double illuminated two-way switch. Possible configurations: double illuminated pushbutton, double illuminated two-way switch, double two-way switch (supplied with 2 lamps Cat. No. 6 650 90 for illuminated functions).	6 647 14	6 648 14

**2. RANGE** (continued)



**2-way switch 10 AX + push-button 6 A - NO-NC contacts - 250 V~**

	Description	Pur	Lin
	Two-way switch + push-button	6 647 09	6 648 09

**Push-buttons NO-NC contact - 6 A - 250 V~**

	1-gang	6 647 05	6 648 05
	Indicator two-way switch Supplied with lamp Cat. No. 6 650 91	6 647 26	-
	2-gang two-way switch 2 contact blocks: NO-NC 6 A	6 647 08	6 648 08
	Push-button with label-holder Supplied with lamp Cat. No 6 650 90 and labels with "bell", "padlock" and "light bulb" symbol.	6 647 15	

**6 AX roller blind and 10 AX ventilation - 250 V~**

	Shutters control switch 3 positions : Up/Stop/Down for direct control of a motor.	6 647 11	6 648 11
	Fan control switch 2 positions: slow or fast speed for direct control of centralised mechanical ventilation.	6 647 91	-

**3. OVERALL DIMENSIONS (mm)**

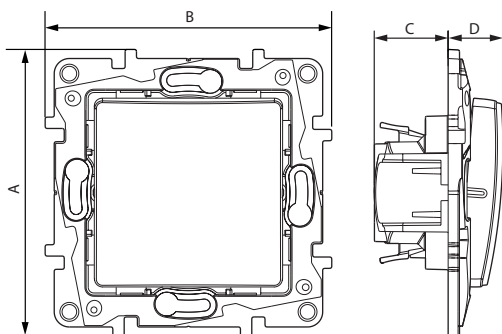

A	B	C	D
75.8	75.8	19.5	14.5

**4. CONNEXION**

Automatic terminals:  
Screw terminals: Cat. Nos. 6 645 03 - 6 647 04.  
The automatic terminal release keys are grey (RAL 735).  
Stripping length: 13 mm only for automatic terminals.  
Compatible with flexible or rigid cables.  
Cable entries for the phase marked with red colour code.

## 5. TECHNICAL CHARACTERISTICS

### ■ 5.1 Index of protection

Protection against solid bodies and liquids: IP 31  
Protection against mechanical impact: IK 04

### ■ 5.2 Material characteristics

Poly gloss appearance  
Colour: White (RAL 903) and Ivory (RAL 113)  
Material: - Rocker plate: ABS  
- Halogen free  
- UV resistance

Material: - Support: PC  
- Colour: Grey (RAL 737)

Self-extinguishing:

+ 850° C / 30 s for insulating parts holding live parts in place.  
+ 650° C / 30 s for other parts made of insulating materials.

### ■ 5.3 Electrical characteristics

Voltage: 250 VAC  
Current: - 10 AX for switch, two-way switch and intermediate switch  
- 6 A for NO-NC pushbuttons  
- 6 AX for roller blind switch

### ■ 5.4 Climatic characteristics

Storage and usage temperature: - 5° C to + 35° C

## 6. MAINTENANCE

Surface cleaning with a cloth.  
Do not use: acetone, tar remover, trichloroethylene.

Maintenance with the following products: Hexane (EN 60669-1),  
Methylated spirit, Soapy water, Diluted ammonia, Bleach diluted to 10%,  
Window-cleaning products.

**Caution:** A preliminary test should be carried out if other specific  
cleaning products are to be used.

## 7. ACCESSORIES

### Monitor and indicator light

Connection by direct mounting  
LED lamp

• **6 650 90**  
230 V indicator light  
Consumption 0.15 mA

• **6 650 91**  
230 V monitor light  
Consumption 3 mA

• **6 650 92**  
12 V - 24 V - 48 V indicator light

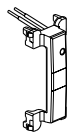

### "Rapido" claw

• **6 650 99**  
For fixing devices in refurbishment projects



## 8. STANDARDS AND APPROVALS

Compliant with installation and manufacturing standards.  
See e-catalogue.