

Plexo™ Timer switch

Cat. No(s): 0 695 04 - 0 696 04

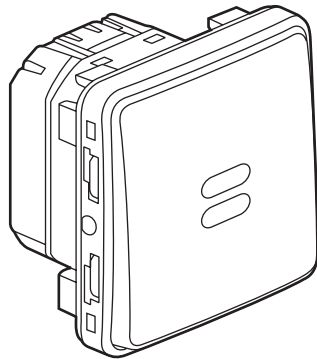

CONTENTS

Page

1. Use	1
2. Range	1
3. Installation	1-2
4. Overall dimensions	2
5. Connection	3
6. Operation	3
7. General characteristics	3
8. Maintenance	3
9. Standards and approvals	3

1. USE

Weatherproof wiring device system designed for residential and professional technical locations (garages, cellars, car parks, workshops and industrial kitchens, etc) as well as for outdoor applications (patios, gardens, camp sites, etc).
 Lighting or heating control with switch-off timer.
 Illuminated product (LED incorporated into mechanism).

2. RANGE

2 versions: grey and white	References
Composable	0 695 04/xx - 0 696 04/xx
Complete surface mounting	0 697 xx
Complete flush mounting	0 698 xx

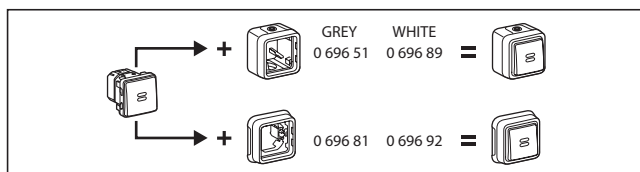

3.1 Surface mounting

- By screwing back box onto support using two Ø 3 mm - Ø 4 mm max. screws.

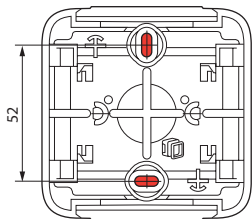

3. INSTALLATION (continued)

3.2 Flush mounting

- With screws on flush box

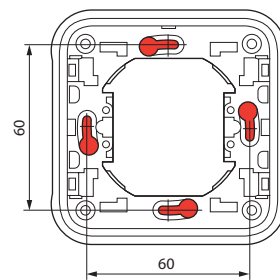

- With claws on flush box

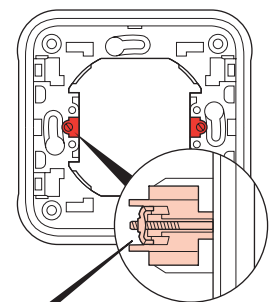

Possibility of fitting claws:
 Cat. No. 0 849 00 or Cat. No. 0 849 01 (long claws)

- On solid faceplate using 4 Ø 4 mm screws.

Drill support material (diameter 60 - 70 mm) using hole saw or hole punch.

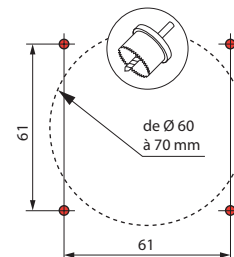
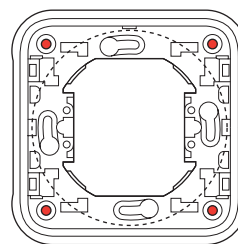

3. INSTALLATION (continued)

■ **3.3 Conduit connection**

Type of conduit:

- **IRL**: formerly IRO, insulating rigid smooth tube
 - **ICA**: insulating flexible bendable corrugated tube
 - **ICTA**: insulating flexible transversally bendable elastic corrugated conduit
 - **ICTL**: insulating flexible transversally bendable elastic smooth conduit
- } Ø 16 - 25 mm

Cables (examples):

- rigid conductors: U - 1000R2V 3G2.5
- flexible conductors: H07 RN - F 3G2.5

Type of entry gland: flexible with membrane, 2 removable types.

- Entry gland with 1 entry supplied with 1 gang box (top and bottom).
- Entry gland with 1 entry supplied with 2 gang and 3 gang boxes (top).
- Entry gland with 2 entries supplied with 2 gang and 3 gang boxes (bottom).

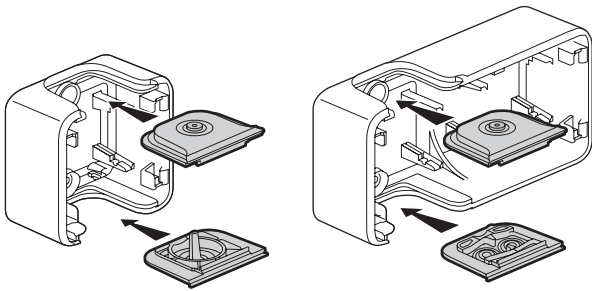

Ø 4 - Ø 15 mm

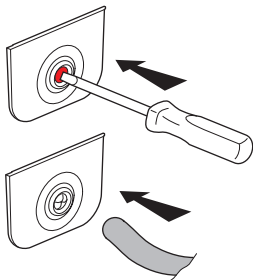

Ø 16/20/25 mm

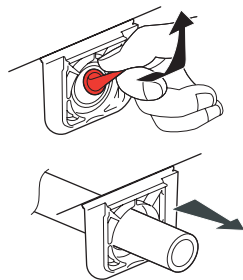

Also available as accessories:

- 0 695 96 grey entry gland 1 entry
- 0 695 99 grey entry gland 2 entries
- 0 696 46 white entry gland 1 entry
- 0 696 49 white entry gland 2 entries

■ **3.4 Assembly**

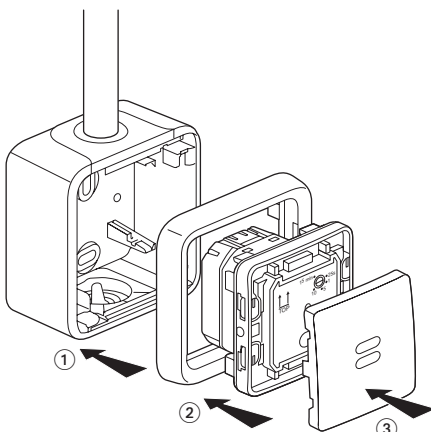

3. INSTALLATION (continued)

IP55 sealing of the front part (cover) on the box is ensured by rotating four 1/4 turn fixings.

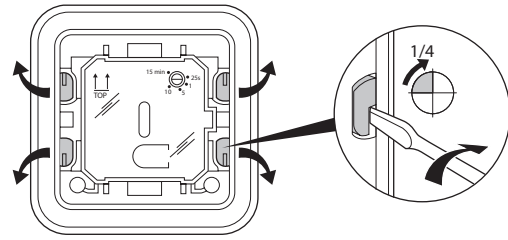

4. OVERALL DIMENSIONS (mm)

■ **Composable**

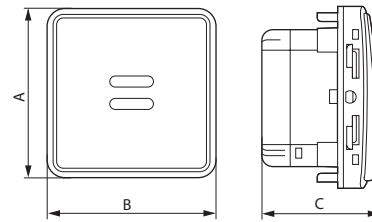

■ **Surface mounting**

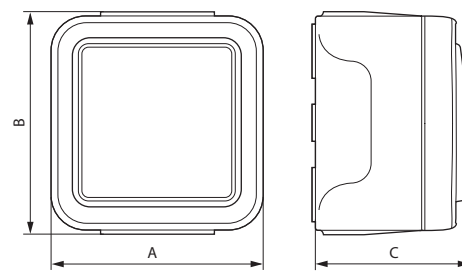

■ **Flush mounting**

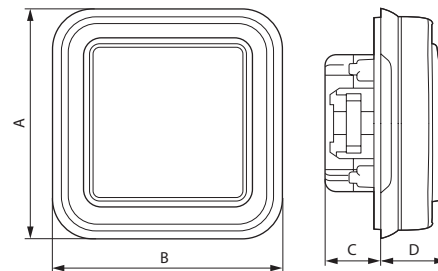

	A	B	C	D
Composable	64	64	47.3	-
Surface mounting	84	80	57	-
Flush mounting	86	86	22	23

5. CONNECTION

Type of terminals: with screws
Terminal capacity: 1.5 mm² to 2.5 mm²
Stripping length: 12 mm

6. OPERATION

6.1 Adjustment

- Remove the switch cover then use a flat screwdriver to set the required timer from 25 seconds to 15 minutes.

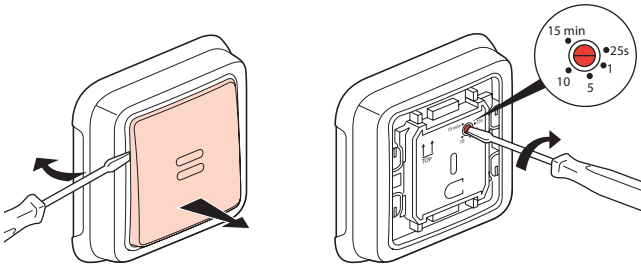

6.2 Operation

- Un appui provoque l'allumage pendant la temporisation.

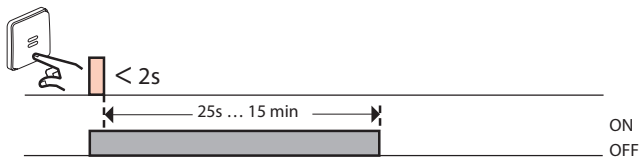

- Press again within 2 seconds during the timer duration to reset the timer.

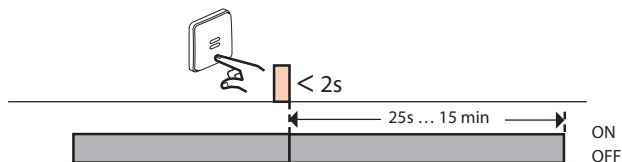

- Press again after 2 seconds during the timer duration to switch off.

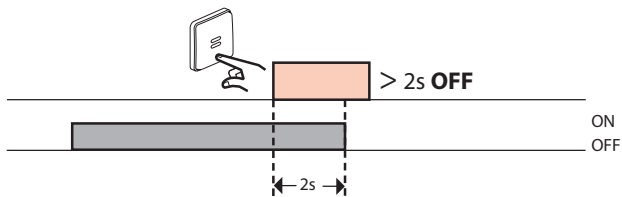

The switch is fitted with an indicator LED.

7. GENERAL CHARACTERISTICS

7.1 Protection class

Protection against solid bodies and liquids: IP 55
Impact test: IK 07

7.2 Material characteristics

Box, support: PP (filled Polypropylene)
Plate, rocker: ABS (Acrylonitrile-Butadiene-Styrene)
Entry gland, trim: PP + SEBS (Styrene-Ethylene-Butadiene-Styrene)
Mechanism: PC (Polycarbonate)

UV resistance: No notable alteration following the 7 day test with 550 W/m² power lighting (Colorimetric measurement using Lab method).
Resistance to salt spray: 7 days (168 h)

Self-extinguishing:

+ 850°C / 30 s for insulating components holding in place live parts.
+ 650°C / 30 s for the other insulating components.

7.3 Electrical characteristics

Current: 8 A
Voltage: 250 V~
Frequency: 50 Hz

8 A cos φ = 1 / 250 V~	1840 W	400 VA	2 x 58 W 14μF	1000 W
400 W	250 VA	400 VA	400 VA	100 W

7.4 Caractéristiques climatiques

Température de stockage et d'utilisation : 0° C à + 35° C

8. MAINTENANCE

Clean surface with dry cloth or cloth soaked in soapy water.
Do not use acetone, tar remover or trichloroethylene.

Caution: A test should be carried out before using any specific cleaners.

9. STANDARDS AND APPROVALS

Compliant with installation and manufacturing standards.
Refer to e. catalogue.