

Soliroc™ - IK 10 vandalproof Plates - Surface-mounting boxes

Cat No(s): 0 778 51/52/53/92/96

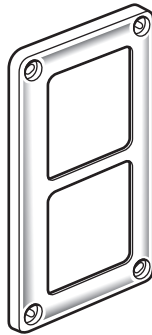

0 778 51



0 778 52

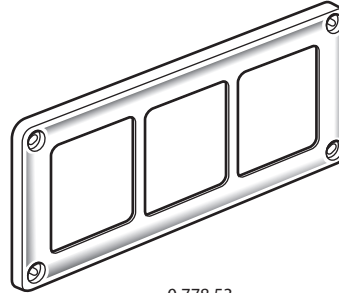

0 778 53

1. USE

Soliroc™ IK10 programme guarantees robust impact resistance in environments that are hazardous or unsupervised, whether indoors or outdoors (warehouses, public buildings, motorway services, offices, shops, schools, confinement institutions, prisons, etc.). Finishing plates made of chrome-plated metal alloy guaranteeing robustness as well as a good resistance to scratches, graffiti, tags and lighter flame. Plates supplied with a set of 4 plugs.

The 5 commitments of the SOLIROC range.

Security: The IK10 rating (20-joule impact force) guarantees optimal impact resistance and protection against vandalism. It is impossible to tear off a SOLIROC product due to the use of four zamak sealing plugs pressed into the plate (removable only by drilling)..

Reliability: The IP55 rating guarantees a long useful lifetime, whether indoors or outdoors. All external parts are made of zamak for optimal robustness.

Practicality: The plate is thin, thereby limiting the amount of possible grip and reducing the risk of it being torn off. Minimal space exists between parts, guaranteed by the IP5X rating (impenetrable by solid bodies greater than 1 mm and protected against dust).

Installation: Depends on the nature of the building. We recommend using 50 mm-deep multi-material or concrete BATIBOX mounting boxes (40 mm accepted). To guarantee the best tear-off resistance:

To guarantee the best tear-off resistance:

- Attach the SOLIROC plates using 4 standard screws (4 mm diameter, 35 mm length).
- Select wall plugs according to the nature of the walls. For concrete walls, we recommend expanding nylon wall plugs (6 mm diameter).

Quality control: factory inspection according to ISO 9001/9002 procedures.

2. RANGE

PLATES

Supplied with 4 blanking plugs

	1-gang plate	0 778 51
	2-gang plate Horizontal or vertical mounting 71 mm fixing centres	0 778 52
	3-gang plate Horizontal or vertical mounting 71 mm fixing centres	0 778 53

SURFACE-MOUNTING FRAMES

Supplied with 6 blanking plugs and 2 screws

Max. depth: 38 mm

ISO 20 cable glands can be mounted:

Cat. No. 3 815 78 (+ nut 3 868 83) and Cat. No. 0 955 03 (+ nut 3 866 32)

Cannot be used for Cat. Nos 0 778 74/75

	1-gang surface-mounting frame	0 778 90
	2-gang surface-mounting frame Horizontal or vertical mounting Spacing 71 mm	0 778 92

3. DIMENSIONS (mm)

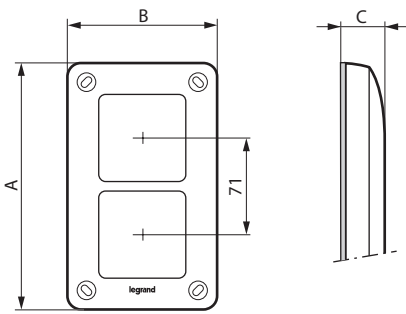

	A	B	C
0 778 51	110	110	13.5
0 778 52	181	110	13.5
0 778 53	252	110	13.5
0 778 90	110	110	45
0 778 92	181	110	45

4. INSTALLATION

■ 4.1 Assembly

Clipping on the cover plate

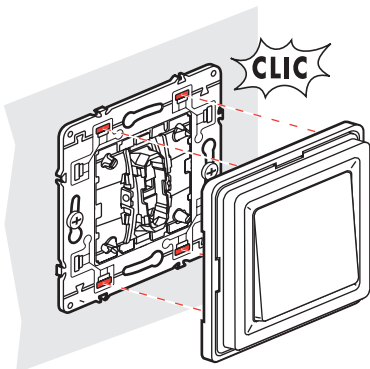

Marking the holes position

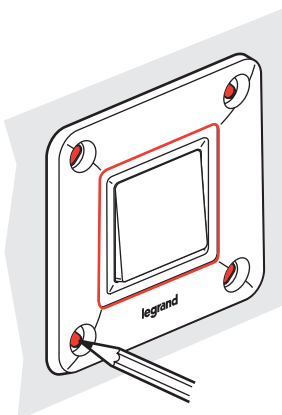

4. INSTALLATION (continued)

Drilling / Pegging

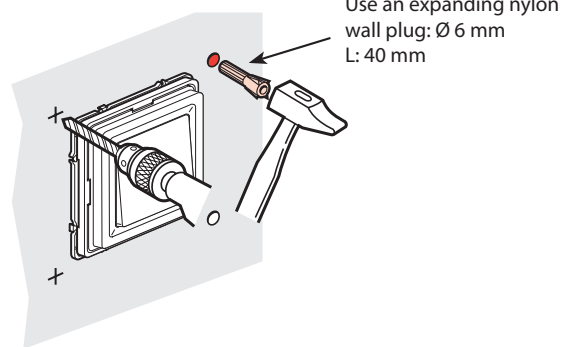

Fixing to the wall

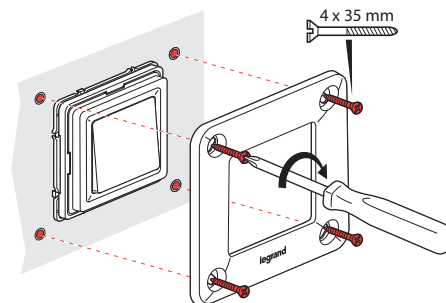

Mounting the supplied plugs

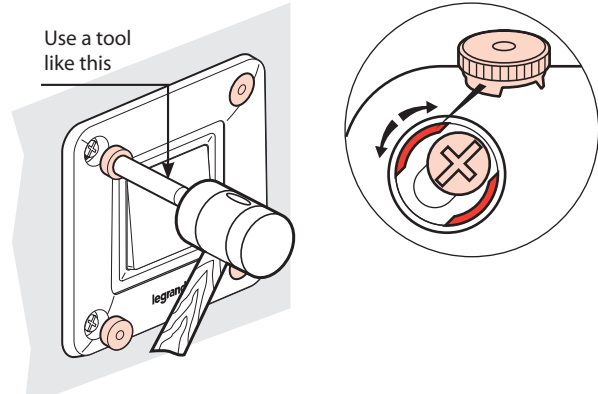

■ 4.2 Disassembly

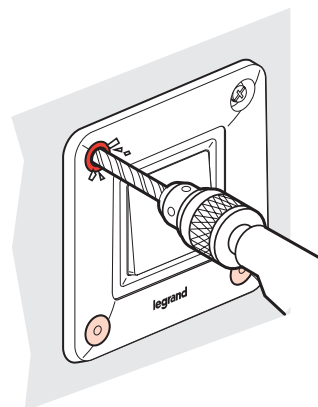

5. TECHNICAL CHARACTERISTICS

■ 5.1 Mechanical characteristics

Protection against impact: IK 10
Max. impact resistance. All products withstand a 20-joule impact force.
Max. tear-off resistance.
Curved shape of the plate to limit the amount of possible grip.

■ 5.2 Material characteristics

Plates: Zamak
Surface treatment: copper plating + acid copper plating + matt nickel plating + approximately 0.1 mm thick chrome plating.
Colour: matt chrome grey.
UV resistant.
Salt spray resistance: 7 days (168 h)
Sub-plate: Polycarbonate
Foam seals: EPDM (Ethylene, Propylene, Diene, Monomer).
Surface-mounting boxes: Polyester
Tested according to the flame of the lighter
Self-extinguishing: 650° C / 30 s

■ 5.3 Climatic characteristics

Storage temperature: - 10° C to + 70° C
Use temperature: - 5° C to + 40° C

6. CLEANING

Bound to cleaning agents without damage agents as:
Hexane, Alcohol burning, Agent for the window, Washning diluted bleach 10 %, Graffiti remover, Acetone, White spirit, Gasoline F.

Caution: An initial test is required for the use of other special maintenance products.

7. ACCESSORIES

BLANKING PLUGS

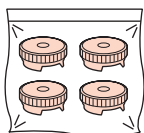

Can only be removed by drilling
Set of 4

0 778 96

SEALS FOR SURFACE CORRECTION

Made of foam to compensate for unevenness of the wall



For 1-gang plate

0 778 85

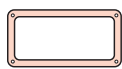

For 2-gang plate

0 778 86



For 3-gang plate

0 778 87

8. STANDARDS AND APPROBALS

Compliance with standards of installation and manufacturing.
See e.catalogue.