

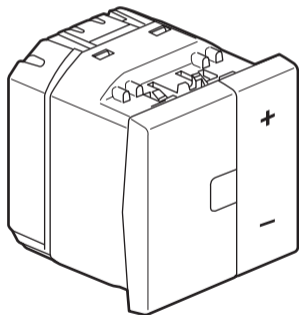



Mosaic™

Périphérique de commande pour variation modulaire

784 10

 **legrand**®



Alimentation	036 80
Consommation	10 mA
	2 x 1,5 mm <sup>2</sup> ou 1 x 2,5 mm <sup>2</sup>
	Profondeur = 40 mm min. 50 mm recommandé
Câble	SYT avec blindage
	câble d'alarme 2 fils 6/10e torsadé réf. 849 17
	1,5 - 2,5 mm <sup>2</sup>
	0°C à + 45°C

LE00031AB

## Câblage

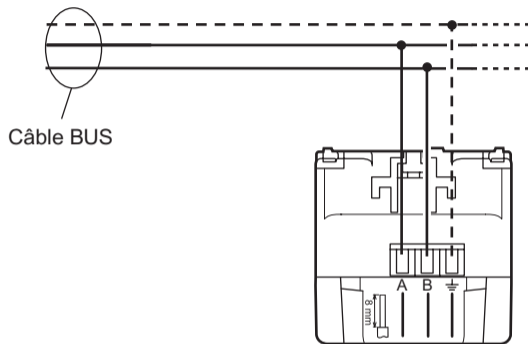

Avant toute intervention, couper le courant.  
Respecter strictement les conditions d'installation et d'utilisation.

## Description

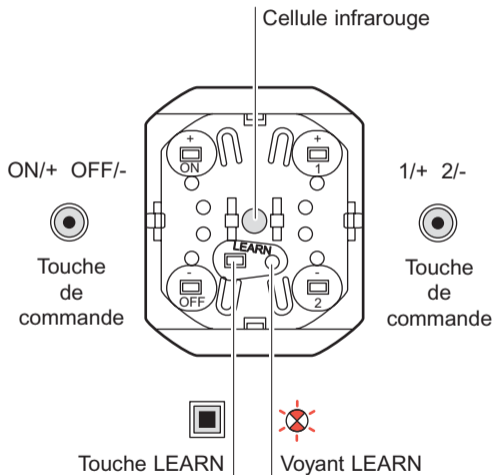

## Configuration d'usine

A la première mise sous tension, l'appui sur les touches ON ou OFF commande l'ensemble des télévariateurs câblés sur le BUS.

Cette possibilité est offerte afin de pouvoir vérifier le bon fonctionnement et raccordement de tous les luminaires.

Un double appui sur la touche LEARN<sup>(1)</sup> annule cette fonction de commande générale.

<sup>(1)</sup> Touche de programmation ou apprentissage.

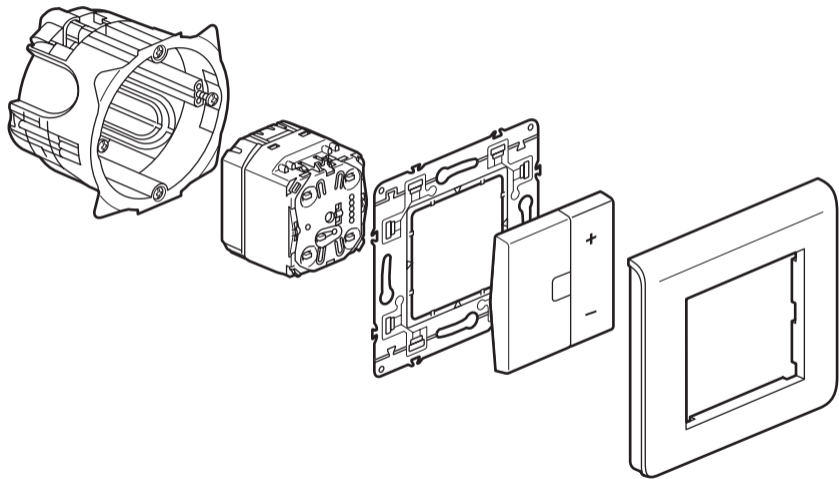

## Fonctionnement

C'est un :

- **Emetteur** : qui peut commander simultanément un ensemble de récepteurs télévariateurs qui lui sont associés lors de l'apprentissage<sup>(1)</sup>.

A partir des touches ON ou OFF, il permet de piloter les points d'éclairage reliés aux récepteurs en :

- **allumage** par un appui court sur la touche ON
- **variation croissante** par un appui long sur la touche ON
- **extinction** par un appui court sur la touche OFF
- **variation décroissante** par un appui long sur la touche OFF.

Seul l'apprentissage de la touche ON est nécessaire, la touche OFF est apprise automatiquement.

A partir des touches 1 et 2 :

Permet de piloter à partir de la touche 1 les points d'éclairage reliés aux récepteurs, en :

- **scénario** (niveau lumineux) par un appui court sur la touche 1
- **variation croissante** par un appui long sur la touche 1.

Permet de piloter à partir de la touche 2 les points d'éclairage reliés aux récepteurs, en :

- **scénario** (niveau lumineux) par un appui court sur la touche 2
- **variation décroissante** par un appui long sur la touche 2.

Pour réaliser la variation de lumière, il est recommandé d'associer le même groupe de récepteurs aux touches 1 et 2.

<sup>(1)</sup> **Apprentissage** : procédure qui permet de définir et d'enregistrer un scénario.

<sup>(2)</sup> **Scénario** : ensemble de commandes exécutées simultanément sur les différents récepteurs qui ont été associés à l'émetteur lors de la procédure d'apprentissage<sup>(1)</sup>.

## Légende

 Le voyant s'éteint

 Le voyant clignote lentement

 Le voyant clignote rapidement

 Le voyant flashe

## Apprentissage du scénario

Etape 1 : débiter l'apprentissage (sur l'ÉMETTEUR)



Appuyer sur LEARN



Appuyer sur la touche de commande qui pilote le scénario

Etape 2 : ajouter un récepteur au scénario (sur le RÉCEPTEUR)



Appuyer sur LEARN



Appuyer sur la touche de commande qui doit être associée à l'émetteur

Pour ajouter plusieurs produits au scénario, répéter pour chaque récepteur les opérations 3 et 4.

Etape 3 : enregistrer le scénario (sur l'ÉMETTEUR)



## Modification d'un scénario

### Etape 1 : ouvrir le scénario (sur l'ÉMETTEUR)



Appuyer sur LEARN

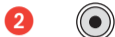

Appuyer sur la touche de commande  
qui doit piloter le scénario

Les voyants de tous les scénarios clignotent

### Etape 2 : modifier l'état d'un récepteur du scénario (sur le RÉCEPTEUR)



Appuyer sur LEARN



Appuyer sur LEARN

ou

pour supprimer le produit  
du scénario passer à l'étape 3

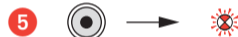

Appuyer sur la touche de commande  
que l'on souhaite associer

### Etape 3 : enregistrer le scénario (sur l'ÉMETTEUR)



Les voyants de tous les produits s'éteignent.  
Le scénario est enregistré.

## Effacement d'un scénario (sur l'EMETTEUR)

Effacer le scénario lié à la touche de commande



Appuyer sur LEARN

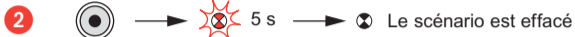

Appuyer sur la touche de commande  
et maintenir 10 s

Effacer tous les scénarios



Appuyer sur LEARN

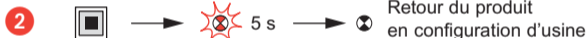

Appuyer sur LEARN  
et maintenir 10 s







Mosaic™

Bedieningsrandapparatuur voor modulaire regeling

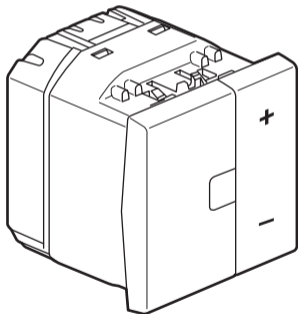
784 10

 **legrand**®



Voeding	036 80
Verbruik	10 mA
	2 x 1,5 mm <sup>2</sup> of 1 x 2,5 mm <sup>2</sup>
	Diepte = min. 40 mm 50 mm aanbevolen
Kabel	SYT met pantsering
	2-draadskabel 6/10e gevlochten ref. 849 17
	1,5 mm <sup>2</sup> - 2,5 mm <sup>2</sup>
	0°C tot + 45°C

## Bekabeling

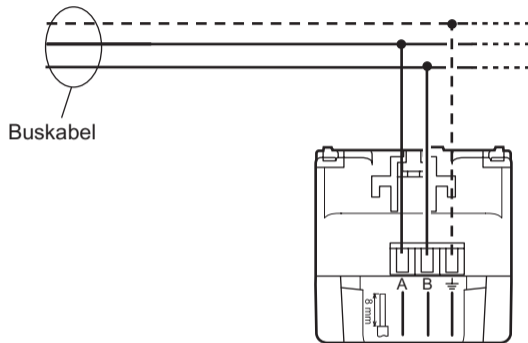

Onderbreek voor enige ingreep de stroom.  
Neem de installatie- en gebruiksvoorwaarden nauwgezet in acht.

## Beschrijving

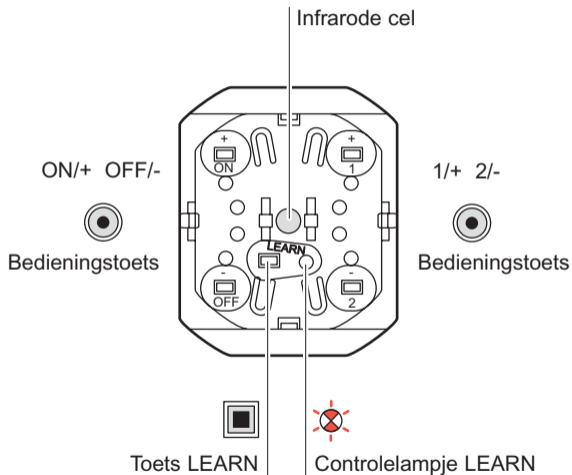

## Standaardconfiguratie

Bij de eerste inschakeling worden door een druk op de toetsen ON of OFF alle op de BUS aangesloten televariators bediend.

Deze mogelijkheid wordt geboden om de goede werking en aansluiting van alle lichten te kunnen controleren.

Door tweemaal op LEARN<sup>(1)</sup> te drukken, wordt deze algemene bedieningsfunctie geannuleerd.

<sup>(1)</sup>Toets voor programmering of inlezen.

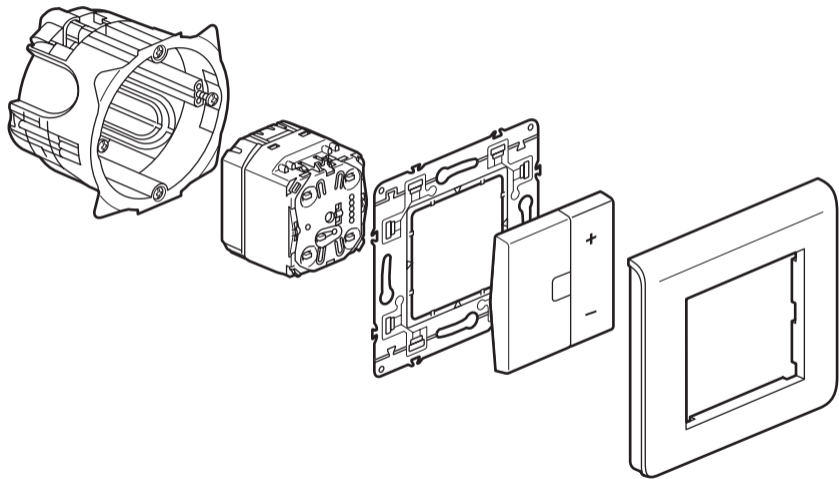

## Werking

Het betreft een :

- **Zender** : die tegelijkertijd een verzameling televariators kan bedienen die hier tijdens het inlezen<sup>(1)</sup> aan gekoppeld zijn.

Met behulp van de toetsen ON of OFF kunnen hiermee de aan de ontvangers gekoppelde verlichtingspunten bediend worden met :

- **inschakelen** door kort op de toets ON te drukken
- **toenemende wijziging** door lang op de toets ON te drukken
- **uitschakelen** door kort op de toets OFF te drukken
- **afnemende wijziging** door lang op de toets OFF te drukken.

Alleen de toets ON hoeft ingelezen te worden, de toets OFF wordt automatisch ingelezen.

Met behulp van de toetsen 1 en 2 :

Hiermee kunnen met behulp van de toets 1 de aan de ontvangers gekoppelde verlichtingspunten bediend worden met :

- **scenario** (lichtniveau) door kort op de toets 1 te drukken
- **toenemende wijziging** door lang op de toets 1 te drukken.

Hiermee kunnen met behulp van de toets 2 de aan de ontvangers gekoppelde verlichtingspunten bediend worden met :

- **scenario** (lichtniveau) door kort op de toets 2 te drukken
- **afnemende wijziging** door lang op de toets 2 te drukken.

Om de lichtsterkte te wijzigen is het aan te raden dezelfde groep ontvangers aan de toetsen 1 en 2 te koppelen.

<sup>(1)</sup> **Inlezen** : procedure waarbij een scenario bepaald en geregistreerd kan worden.

<sup>(2)</sup> **Scenario** : het geheel van alle gelijktijdig uitgevoerde commando's op de diverse ontvangers die tijdens het inlezen aan de uitzender verbonden zijn<sup>(1)</sup>.

## Legende

 Het controlelampje gaat uit

 Het controlelampje knippert langzaam



 Het controlelampje knippert snel

 Het controlelampje flitst

## Inlezen van het scenario



Stap 1 : beginnen met aanleren (op de LEADER)

**1**  →   
Druk op  
LEARN

**2**  →   
Druk op de bedieningstoets  
die het scenario bestuurt

Stap 2 : voeg een actor toe aan het scenario (op de ACTOR)

**3**  →   
Druk op  
LEARN

**4**  →   
Druk op de bedieningstoets  
die aan de leider moet zijn toegevoegd

Herhaal voor het toevoegen van meerdere producten aan het scenario voor iedere actor de handelingen **3** en **4**.

Stap 3 : het scenario registreren (op de LEADER)

**5**  →  Druk op  
LEARN →  De controlelampjes van alle producten gaan uit.  
Het scenario is geregistreerd.

## Wijziging van een scenario

### Stap 1 : het scenario openen (op de LEADER)

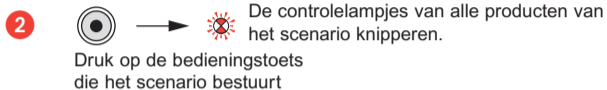

### Stap 2 : de staat van een actor van het scenario wijzigen (op de ACTOR)

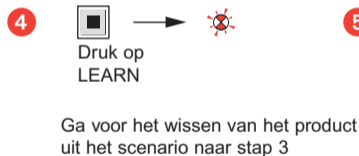
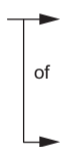

### Stap 3 : het scenario registreren (op de LEADER)



## Wissen van een scenario

Wis alle scenario's die verbonden zijn met de bedieningstoets (op de LEADER)



Wis alle scenario's die bij dit product horen (op de LEADER)

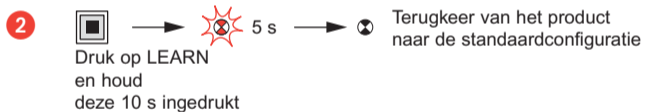







Mosaic™

Peripheral control for modular dimming

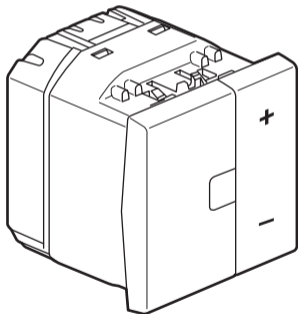
784 10

 **legrand**®



Supply voltage	036 80
Consumption	10 mA
	2 x 1.5 mm <sup>2</sup> or 1 x 2.5 mm <sup>2</sup>
	Depth = 40 mm min. 50 mm recommended
Cable	SYT with shielding
	2 pair 6/10th twisted Cat. No. 849 17
	1.5 mm <sup>2</sup> - 2.5 mm <sup>2</sup>
	0°C to + 45°C

## Cabling

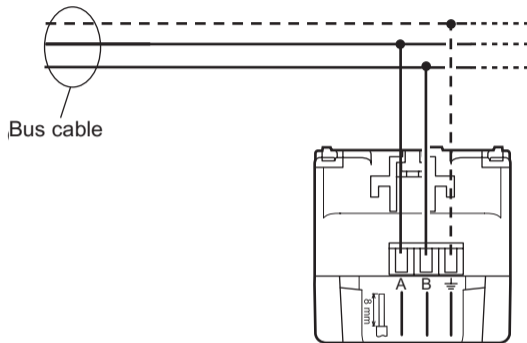

Make sure the power supply is disconnected before any intervention  
Strictly comply with instructions for installation and use.

## Description

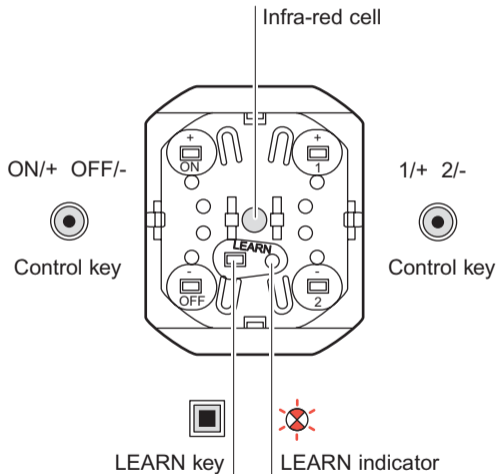

## Factory configuration

On first powering up, pressing the ON or OFF keys will control all the remote dimmers cabled onto the BUS.

This facility is provided in order to be able to check that all the lights are functioning correctly and are connected.

Pressing twice on the LEARN<sup>(1)</sup> key cancels this general control function.

<sup>(1)</sup>Programming or learn key.



## Functions

It is a :

- **Transmitter** : able to control simultaneously a set of remote dimmers which are linked to it during the learning stage<sup>(1)</sup>.

Using the ON or OFF keys, the lighting points linked to the receivers can be controlled as follows :

- **lighting** by a short press on the ON key
- **increasing dimming** by a long press on the ON key
- **switching off** by a short press on the OFF key
- **decreasing dimming** by a long press on the OFF key.

It is only necessary to program the ON key, the OFF key learns automatically.

Using the 1 and 2 keys :

Enables the lighting points linked to the receivers to be controlled as follows :

- **scenario** (light level) by a short press on key 1
- **increased dimming** by a long press on key 1.

Enables the lighting points linked to the receivers to be controlled as follows :

- **scenario** (light level) by a short press on key 2
- **reducing dimming** by a long press on key 2.

To carry out light dimming, it is recommended that you link the same group of receivers to keys 1 and 2.

<sup>(1)</sup> **Learning** : procedure enabling a scenario to be defined and recorded.

<sup>(2)</sup> **Scenario** : a set of controls carried out simultaneously on the various receivers which have been linked to the receiver during the learning<sup>(1)</sup> procedure.

## Key

 The indicator light switches off

 The indicator light flashes slowly



 The indicator light flashes quickly

 The indicator light flashes

## Learning a scenario



Step 1 : Start the learning phase (on the TRANSMITTER)

**1**  →   
Press LEARN

**2**  →   
Press the control button that is to control the scenario

Step 2 : Add an actor to the scenario (on the RECEIVER)

**3**  →   
Press LEARN

**4**  →   
Press the control button to be linked to the transmitter

To add several products to the scenario, repeat operations **3** and **4** for each receiver.

Step 3 : Save the scenario (on the TRANSMITTER)

**5**  →  Press LEARN →  The indicator lights of all products switch off.  
The scenario has been saved.

## Modifying a scenario

### Step 1: Open the scenario (on the TRANSMITTER)

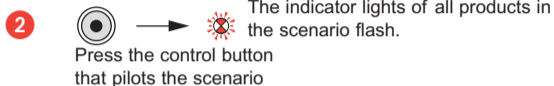

### Step 2 : Modify the state of an actor in the scenario (on the RECEIVER)

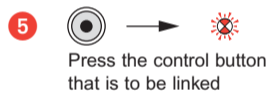
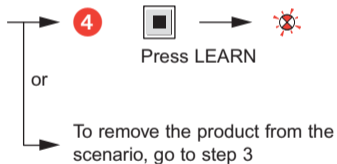

### Step 3 : Save the scenario (on the TRANSMITTER)



## Clearing a scenario (on the TRANSMITTER)

Clear all scenarios linked to the control button

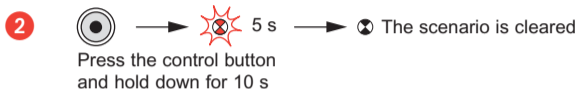

Clear all scenarios linked to this product

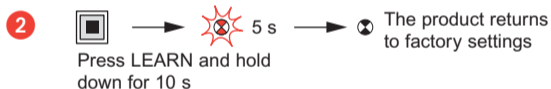







Mosaic™

Hilfsschalter zum Ansteuern eines modularen Ferndimmers

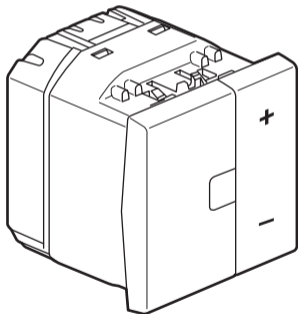
784 10

 **legrand**®



Netzanschluss	036 80
Eigenverbrauch	10 mA
	2 x 1,5 mm <sup>2</sup> oder 1 x 2,5 mm <sup>2</sup>
	Tiefe = min. 40 mm 50 mm empfohlen
Kabel	SYT mit Abschirmung
	2-Leiterkabel 6/10 verseilt Art.-Nr. 849 17
	1,5 mm <sup>2</sup> - 2,5 mm <sup>2</sup>
	0°C bis + 45°C

## Verdrahtung

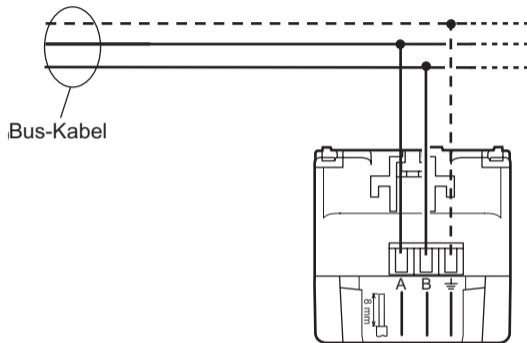

Vor jeglichem Eingriff die Spannungsfreiheit sicherstellen.  
Einbau- und Gebrauchsanleitungen sind genau zu beachten.

## Beschreibung

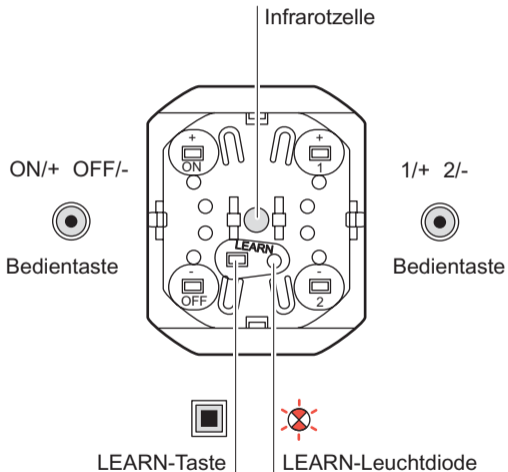

## Werkseinstellung

Bei erstmaliger Inbetriebnahme werden durch Drücken der Tasten ON oder OFF sämtliche auf dem Bus verdrahteten Ferndimmer angesteuert.

Diese Funktion dient der Prüfung des einwandfreien Betriebs aller Leuchtkörper.

Ein zweimaliges Drücken der LEARN-Taste<sup>(1)</sup> löscht diese Funktion der Zentralansteuerung.

<sup>(1)</sup> Programmier- oder Einlerntaste.

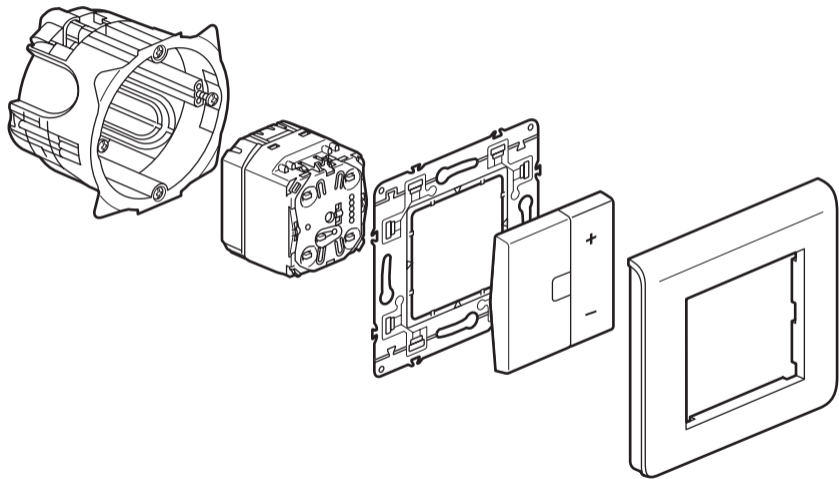

## Funktionsweise

Dies ist ein :

- **Sender**, der gleichzeitig eine Reihe von Empfänger-Ferndimmern ansteuern kann, die ihm beim Einlernen<sup>(1)</sup> zugeordnet wurden.

Mit den Tasten ON oder OFF kann man die an die Empfänger angeschlossenen Leuchtkörper folgendermaßen steuern :

- **Einschalten** durch kurzes Drücken der ON-Taste.
- **Zunehmendes Dimmen** durch langes Drücken der ON-Taste.
- **Abschalten** durch kurzes Drücken der OFF-Taste.
- **Abnehmendes Dimmen** durch langes Drücken der OFF-Taste.

Es muss nur die ON-Taste eingelernt werden, die OFF-Taste wird automatisch eingelernt.

Tasten 1 und 2 :

Mit der Taste 1 kann man die an die Empfänger angeschlossenen Leuchtkörper folgendermaßen steuern :

- **Szenario** (Beleuchtungsniveau) durch kurzes Drücken der Taste 1.
- **Zunehmendes Dimmen** durch langes Drücken der Taste 1.

Mit der Taste 2 kann man die an die Empfänger angeschlossenen Leuchtkörper folgendermaßen steuern :

- **Szenario** (Beleuchtungsniveau) durch kurzes Drücken der Taste 2.
- **variation décroissante** durch langes Drücken der Taste 2.

Zum Dimmen des Lichts wird empfohlen, den Tasten 1 und 2 die gleiche Gruppe von Empfängern zuzuordnen.

<sup>(1)</sup> **Einlernen** : Vorgang zum Festlegen und Abspeichern eines Szenarios

<sup>(2)</sup> **Szenario** : Eine Reihe von Steuerbefehlen, die gleichzeitig an den verschiedenen Empfängern, die dem Sender beim Einlernvorgang<sup>(1)</sup> zugeordnet wurden, ausgeführt werden.

## Legende

 Die Leuchtdiode erlischt



 Die Leuchtdiode blinkt langsam ca. 1Hz



 Die Leuchtdiode blinkt schnell ca. 2Hz

 Die Leuchtdiode blitzt ca. 5Hz

## Einlernen der Teilnehmer



### 1. Schritt : Einlernmodus aktivieren (auf dem Sensor)

**1**  →   
Die Lerntaste LEARN drücken  
(Lernmodus aktivieren)

**2**  →   
Bedientaste drücken, die dem Aktor  
zugeordnet werden soll.

### 2. Schritt : Einlernmodus aktivieren (auf dem Aktor)

**3**  →   
Die Lerntaste  
LEARN drücken

**4**  →   
Bedientaste drücken, die den Sensor  
zugeordnet werden soll.

Um mehrere Aktor einen Sensor zuzuordnen, die Arbeitsschritte **3** und **4** bei jedem der betreffenden Aktoren wiederholen.

### 3. Schritt : Einlernmodus beenden

**5**  →  →   
Die Lerntaste LEARN am Sensor  
drücken (Lernmodus schließen)

Die Leuchtdiode der LEARN Taste erlischt auf allen eingelernten Aktoren. Der Einlernprozess ist abgeschlossen.

## Änderung einer Funktionszuordnung (löschen oder zusätzlich einlernen)

### 1. Schritt : Auswahl der Funktion am Sensor

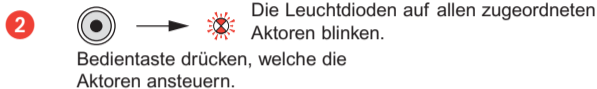

### 2. Schritt : Aktor am Sensor hinzufügen oder löschen (am AKTOR)



Um den Aktor aus der Sensor Konfiguration zu löschen, die Lerntaste LEARN drücken. Die Leuchtdioden der LEARN Taste erlischt auf allen Aktoren. Der Prozess ist abgeschlossen.

### 3. Schritt : Funktionszuordnung beenden



## Löschen aller Funktionszuordnung oder Aktoren

Alle eingelernte Zuordnungen einer Bedienteste am Sensor löschen

-  →   
Die Lerntaste LEARN drücken
-  →  5 s →  Die Zuordnung ist gelöscht

Alle Sensoren oder Aktoren auf Werkseinstellung zurücksetzen

-  →   
Die Lerntaste LEARN drücken
-  →  5 s →  Das Produkt kehrt zur Werkseinstellung zurück.







Mosaic™

Periférico de mando para variación modular

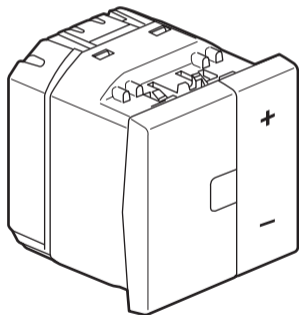
784 10

 **legrand**®



Alimentación	036 80
Consumo	10 mA
	2 x 1,5 ó 1 x 2,5 mm <sup>2</sup>
	Profundidad = 40 mm mínimo 50 mm recomendado
Cable	SYT con blindaje
	cable retorcido de dos hilos 6/10 Ref. 849 17
	1,5 - 2,5 mm <sup>2</sup>
	0°C à + 45°C

## Cableado

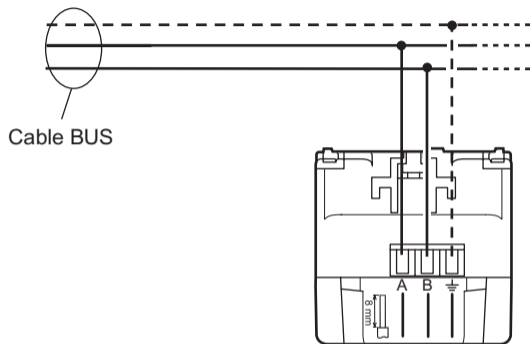

Cortar la corriente antes de realizar cualquier intervención.  
Respetar estrictamente las condiciones de instalación y de utilización.

## Descripción

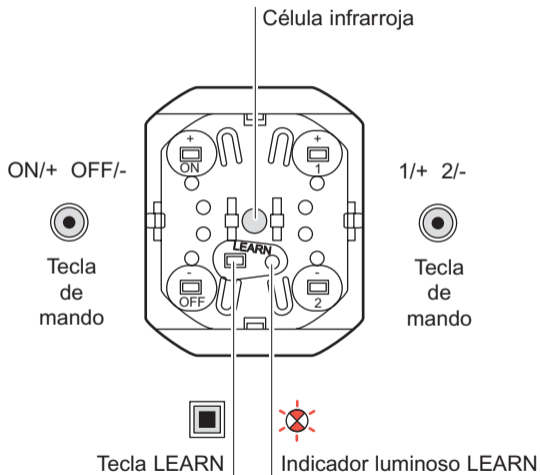

## Configuración de fábrica

A la primera puesta en tensión, la pulsación de las teclas ON u OFF controla todos los televariadores cableados en el BUS.

Se ofrece esta posibilidad para poder verificar que todas las luminarias funcionen bien y estén bien conectadas.

Una doble pulsación de la tecla LEARN<sup>(1)</sup> anula esta función de mando general.

<sup>(1)</sup>Tecla de programación o aprendizaje.

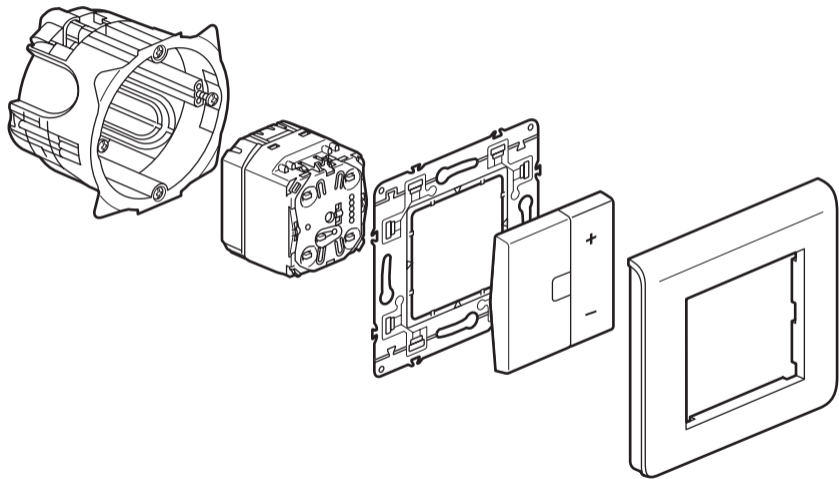

## Funcionamiento

Es un:

- **Emisor** : que puede controlar simultáneamente un conjunto de receptores televiadores que se le asocian durante el aprendizaje <sup>(1)</sup>.

Las teclas ON u OFF permiten controlar los puntos de iluminación conectados a los receptores en:

- **encendido**, pulsando cortamente la tecla ON
- **variación** creciente, pulsando largamente la tecla ON
- **extinción**, pulsando cortamente la tecla OFF
- **variación** decreciente, pulsando largamente la tecla OFF.

Sólo es necesario el aprendizaje de la tecla ON; la tecla OFF se aprende automáticamente.

Con las teclas 1 y 2:

Con la tecla 1 se puede controlar los puntos de iluminación conectados a los receptores, en:

- **escenario** (nivel luminoso), pulsando cortamente la tecla 1
- **variación creciente**, pulsando largamente la tecla 1.

Con la tecla 2 se puede controlar los puntos de iluminación conectados a los receptores, en:

- **escenario** (nivel luminoso), pulsando cortamente la tecla 2
- **variación decreciente**, pulsando largamente la tecla 2.

Para realizar la variación de luz, se recomienda asociar el mismo grupo de receptores a las teclas 1 y 2.

<sup>(1)</sup> **Aprendizaje**: procedimiento que permite definir y registrar un escenario.

<sup>(2)</sup> **Escenario**: conjunto de mandos ejecutados simultáneamente en los diferentes receptores que han sido asociados al emisor durante el procedimiento de aprendizaje<sup>(1)</sup>.

## Leyenda



Led Off



Parpadeo lento



Parpadeo rápido



Flash

## Aprendizaje del escenario

Paso 1 : crear el escenario, fase LEARN (en el EMISOR)



Pulsar LEARN



Pulsar la tecla de mando que va a controlar el escenario

Paso 2 : añadir un actor al escenario (en el RECEPTOR)



Pulsar LEARN



Pulsar la tecla de mando que va a estar asociada al líder

Para asociar más mecanismos al escenario, repetir en cada receptor las operaciones 3 y 4.

Paso 3 : grabar el escenario (en el EMISOR)

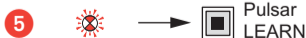

El led en todos los mecanismos se apaga  
El escenario ha sido grabado

## Modificación de un escenario

### Paso 1 : abrir el escenario (en el EMISOR)



Pulsar LEARN

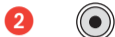

Pulsar la tecla de mando que controla el escenario

El led de todos los mecanismos del escenario parpadea

### Paso 2 : modificar el estado de un actor del escenario (en el RECEPTOR)



Pulsar LEARN



Pulsar LEARN

o

Para eliminar el producto del escenario ir al punto "Grabar el escenario"

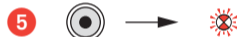

Pulsar la tecla de mando que va a estar asociada

### Paso 3 : grabar el escenario (en el EMISOR)



Pulsar LEARN



El led de todos los mecanismos se apaga  
El escenario ha sido grabado

## Borrado de un escenario (en el EMISOR)

Borrar todos los escenarios vinculados a la tecla de mando



Pulsar LEARN



Pulsar la tecla de mando durante 10s

Borrar todos los escenarios vinculados a este producto



Pulsar LEARN



Pulsar LEARN durante 10s







Mosaic™

Periférico de comando para variação modular

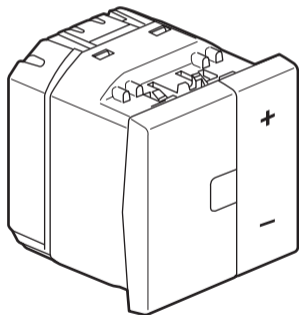
784 10

 **legrand**®



Alimentação	036 80
Consumo	10 mA
	2 x 1,5 mm <sup>2</sup> ou 1 x 2,5 mm <sup>2</sup>
	Profundidade = 40 mm min. 50 mm recomendado
Cabo	SYT com blindagem
	Cabo de alarme 2 condutores entrançados 6/10e Ref. 849 17
	1,5 mm <sup>2</sup> - 2,5 mm <sup>2</sup>
	0°C a + 45°C

## Esquema de ligações

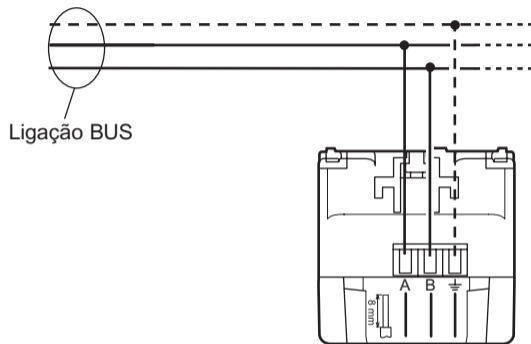

Desligar a alimentação antes de qualquer intervenção.  
Devem ser respeitadas as condições de instalação e utilização.

## Descrição

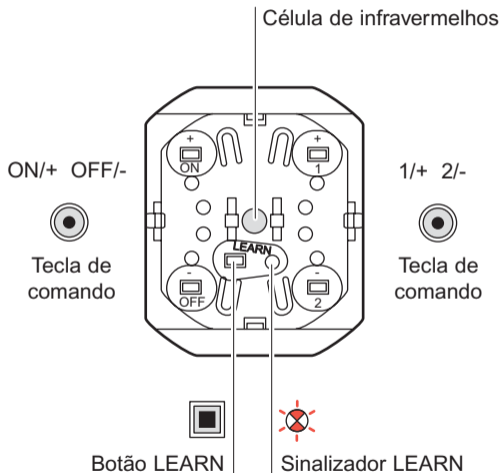

## Configuração de fábrica

Na primeira ligação à rede eléctrica, a pressão das teclas ON ou OFF comanda o conjunto dos televariadores ligados à linha de BUS.

Esta programação inicial permite verificar o bom funcionamento e correcta ligação de todas as luminárias.

Para anular esta função de comando geral basta pressionar duas vezes o botão LEARN<sup>(1)</sup>.

<sup>(1)</sup> Botão de programação ou memorização.

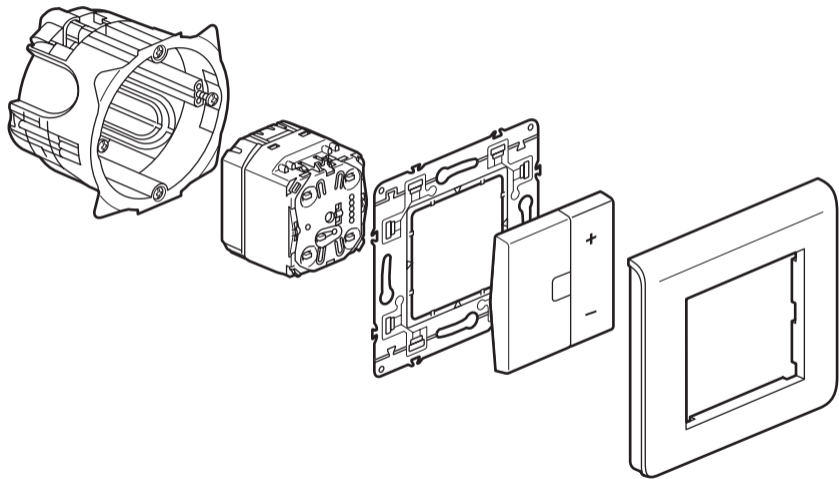

## Funcionamento

- **Como emissor** : pode controlar simultaneamente um grupo de televariadores receptores que lhe tenham sido associados durante o procedimento de memorização<sup>(1)</sup>.

Este aparelho permite controlar os pontos de luz ligados aos receptores :

Através das teclas ON e OFF :

- **Acende** – por pressão da tecla ON (toque breve)
- **Variação crescente** – por pressão da tecla ON (toque prolongado)
- **Apaga** – por pressão da tecla OFF (toque breve)
- **Variação decrescente** – por pressão da tecla OFF (toque prolongado).

Através das teclas 1 e 2 :

Permet de piloter à partir de la touche 1 les points d'éclairage reliés aux récepteurs, en :

- **Cenário** (nível de iluminação) – por pressão da tecla 1 (toque breve)
- **Variação crescente** – por pressão da tecla 1 (toque prolongado)
- **Cenário** (nível de iluminação) – por pressão da tecla 2 (toque breve)
- **Variação decrescente** – por pressão da tecla 2 (toque prolongado)

Nota : Para variação do nível de iluminação, é recomendado associar o mesmo grupo de receptores às teclas 1 e 2.

<sup>(1)</sup> **Memorização** : acção que permite definir um cenário.

<sup>(2)</sup> **Cenário** : conjunto de comandos executados simultaneamente em diferentes receptores, que foram associados a um emissor durante o procedimento de memorização<sup>(1)</sup>.

## Legenda

 O indicador luminoso apaga-se

 O indicador luminoso pisca lentamente

 O indicador luminoso pisca rapidamente

 O indicador luminoso acende-se rapidamente

## Memorização do cenário

Etapa 1 : iniciar a memorização (em LÍDER)



Premir LEARN



Premir a tecla de comando que deve pilotar o cenário

Etapa 2 : acrescentar um actor ao cenário (em ACTOR)



Premir LEARN



Premir a tecla de comando que deve ser associada ao líder

Para acrescentar vários produtos ao cenário, repetir para cada actor as operações 3 e 4.

Etapa 3 : gravar o cenário (em LÍDER)

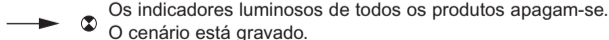

## Modificação de um cenário

### Etapa 1 : abrir o cenário (em LÍDER)



Premir LEARN



Premir a tecla de comando que pilota o cenário

Os indicadores luminosos de todos os produtos piscam

### Etapa 2: modificar o estado de um actor do cenário (em ACTOR)



Premir LEARN



Premir LEARN

ou

Para suprimir o produto do cenário  
passar à etapa 3

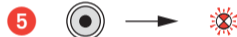

Premir a tecla de comando que se deseja associar

### Etapa 3: gravar o cenário (em LÍDER)



Premir LEARN

Os indicadores luminosos de todos os produtos apagam-se.  
O cenário está gravado.

## Supressão de um cenário (em LÍDER)

Suprimir todos os cenários ligados à tecla de comando (em LÍDER)

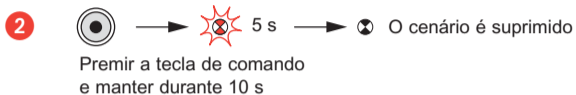

Suprimir todos os cenários ligados este produto (em LÍDER)

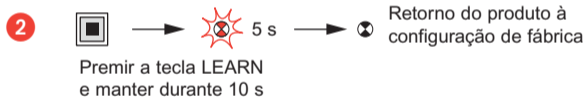







Mosaic™

Περιφερειακός ελέγχου για δομοστοιχειωτή ρύθμιση

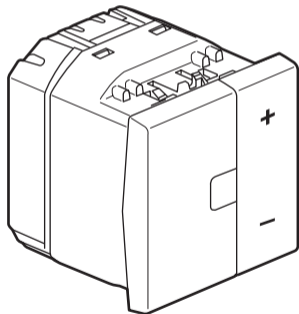
784 10

 legrand®



Τροφοδοσία	036 80
Κατανάλωση	10 mA
	2 x 1,5 mm <sup>2</sup> ή 1 x 2,5 mm <sup>2</sup>
	Βάθος = 40 mm ελάχ. 50 mm συνιστώμενο
Καλώδιο	SYT με θωράκιση
	καλώδιο 2 συρμάτων 6/10 <sup>o</sup> συνεστραμμένο κωδ. 849 17
	1,5 mm <sup>2</sup> - 2,5 mm <sup>2</sup>
	0°C έως + 45°C

## Καλωδίωση

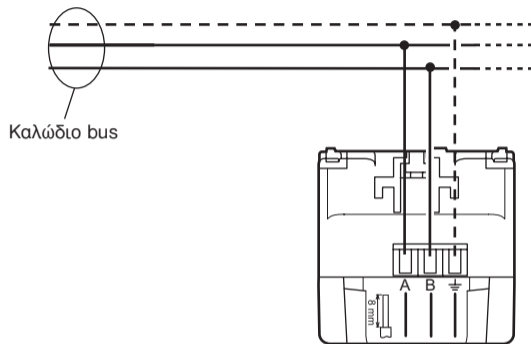

Πριν από οποιαδήποτε επέμβαση, κόψτε το ρεύμα.  
Τηρήστε αυστηρά τις συνθήκες εγκατάστασης και χρήσης.

## Περιγραφή

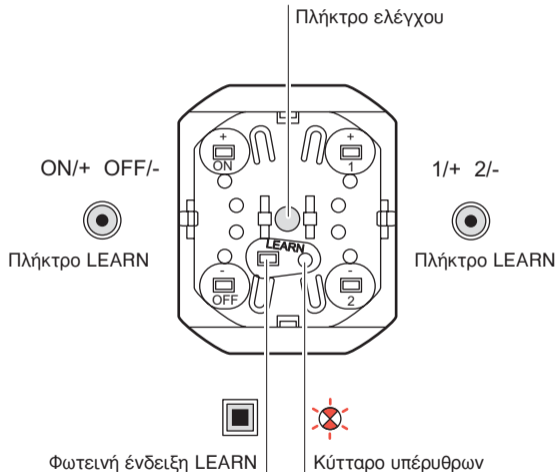

## Εργοστασιακή διαμόρφωση

Κατά την πρώτη θέση υπό τάση, το πάτημα των πλήκτρων ON ή OFF ελέγχει το σύνολο των τηλερυθμιστών έντασης που

είναι συνδεδεμένοι με το BUS.

Η δυνατότητα αυτή προσφέρεται ώστε να μπορεί να ελεγχθεί η σωστή λειτουργία και σύνδεση όλων των φωτιστικών.

Το διπλό πάτημα του πλήκτρου LEARN<sup>(1)</sup> ακυρώνει αυτή τη λειτουργία γενικού ελέγχου.

<sup>(1)</sup> Πλήκτρο προγραμματισμού ή εκμάθησης.



## Λειτουργία

Πρόκειται για έναν :

• Πομπό: ο οποίος μπορεί να ελέγχει ταυτόχρονα ένα σύνολο δεκτών-τηλερυθμιστών που συνδυάζονται μαζί του κατά την εκμάθηση<sup>(1)</sup>.

Με τα πλήκτρα ON ή OFF, επιτρέπει τον έλεγχο των σημείων φωτισμού που είναι συνδεδεμένα με τους δέκτες όσον αφορά :

- **το άναμμα** με βραχύ πάτημα στο πλήκτρο ON
- **την αυξανόμενη ρύθμιση έντασης** με παρατεταμένο πάτημα του πλήκτρου ON
- **το σβήσιμο** με βραχύ πάτημα του πλήκτρου OFF
- **τη φθίνουσα ρύθμιση έντασης** με παρατεταμένο πάτημα του πλήκτρου OFF.

Μόνον η εκμάθηση του πλήκτρου ON είναι απαραίτητη, το πλήκτρο OFF μαθαίνεται αυτόματα.

Με τα πλήκτρα 1 και 2 :

Επιτρέπει τον έλεγχο, με το πλήκτρο 1, των σημείων φωτισμού που είναι συνδεδεμένα με τους δέκτες όσον αφορά :

- **το σενάριο** (φωτεινό επίπεδο) με βραχύ πάτημα στο πλήκτρο 1
- **την αυξανόμενη ρύθμιση έντασης** με παρατεταμένο πάτημα του πλήκτρου 1.

Επιτρέπει τον έλεγχο, με το πλήκτρο 2, των σημείων φωτισμού που είναι συνδεδεμένα με τους δέκτες όσον αφορά :

- **το σενάριο** (φωτεινό επίπεδο) με βραχύ πάτημα του πλήκτρου 2
- **τη φθίνουσα ρύθμιση έντασης** με παρατεταμένο πάτημα του πλήκτρου 2.

Για να πραγματοποιηθεί η ρύθμιση έντασης φωτισμού, συνιστάται να συνδυάζεται η ίδια ομάδα δεκτών με τα πλήκτρα 1 και 2.

<sup>(1)</sup> **Εκμάθηση** : διαδικασία που επιτρέπει τον ορισμό και την αποθήκευση ενός σεναρίου.

<sup>(2)</sup> **Σενάριο** : σύνολο ελέγχων που πραγματοποιούνται ταυτόχρονα σε διάφορους δέκτες οι οποίοι συνδυάστηκαν με τον πομπό κατά τη διαδικασία εκμάθησης <sup>(1)</sup>.

## Λεζάντα

 Η φωτεινή ένδειξη σβήνει

 Η φωτεινή ένδειξη αναβοσβήνει αργά

 Η φωτεινή ένδειξη αναβοσβήνει γρήγορα

 Η φωτεινή ένδειξη αναβοσβήνει έντονα

## Επεξήγηση κατάσταση φωτεινής ένδειξης

Στάδιο 1 : Ξεκίνημα της εκμάθησης (επάνω στο LEADER)



Πατήστε το LEARN



Πατήστε το πλήκτρο ελέγχου το οποίο θα ελέγχει το σενάριο

Στάδιο 2 : προσθέστε έναν actor στο σενάριο (επάνω στον actor)



Πατήστε το LEARN



Πατήστε το πλήκτρο ελέγχου που θέλετε να συνδυάσετε με το leader

Για να προσθέσετε πολλά προ πίντα στο σενάριο, επαναλάβετε για κάθε ένα απί αυτά (actors) τις ενέργειες 3 και 4.

Στάδιο 3 : αποθηκεύστε το σενάριο (επάνω στο LEADER)



Οι ωτεινές ενδείξεις φίλων των προ πίντων σβήνουν. Το σενάριο αποθηκεύτηκε.

## Τροποποίηση ενφίς σεναρίου

Στάδιο 1 : ανοίξτε το σενάριο (επάνω στο LEADER)

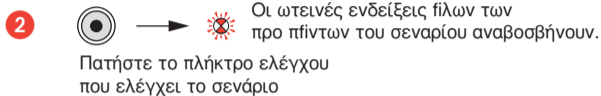

Στάδιο 2: τροποποίηση της κατάστασης ενφίς actor του σεναρίου (επάνω στον actor)

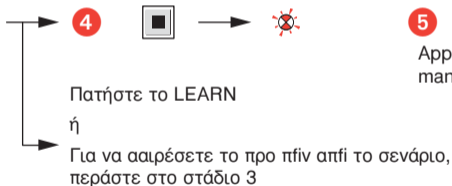

Στάδιο 3 : αποθηκεύστε το σενάριο (επάνω στο LEADER)



## Διαγραφή ενφίς σεναρίου

Διαγράψτε φίλα τα σενάρια που συνδυάζονται με το πλήκτρο ελέγχου (επάνω στο LEADER)



Πατήστε το LEARN

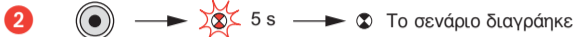

Πατήστε το πλήκτρο ελέγχου και κρατήστε το πατημένο για 10s

Διαγράψτε φίλα τα σενάρια που συνδυάζονται με το προ πον αυτί (επάνω στο LEADER))



Πατήστε το LEARN



Πατήστε το πλήκτρο ελέγχου και κρατήστε το πατημένο για 10s







Mosaic™

Sterujące urządzenie peryferyjne do modułowej zmiany  
natężenia oświetlenia

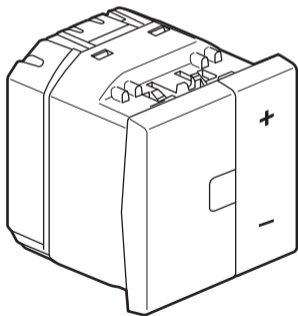
784 10

 **legrand**®



Zasilanie	036 80
Zużycie energii	10 mA
	2 x 1,5 mm <sup>2</sup> lub 1 x 2,5 mm <sup>2</sup>
	Głębokość = min. 40 mm Zalecana : 50 mm
Kabel	SYT z ekranem
	kabel 2-przewodowy 6/10e skręcony <b>symb. 849 17</b>
	1,5 mm <sup>2</sup> - 2,5 mm <sup>2</sup>
	0°C do + 45°C

## Okablowanie

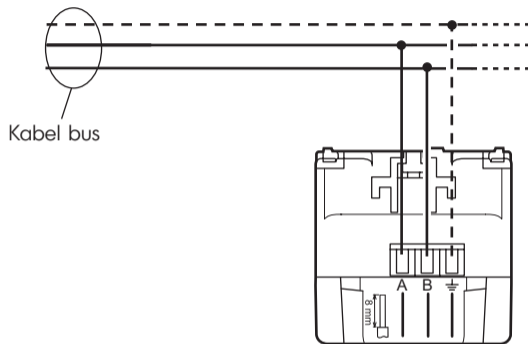

Przed każdą operacją wykonywaną na urządzeniu, odciąć dopływ prądu.  
Ściśle przestrzegać zasad montażu i użytkowania.

## Opis

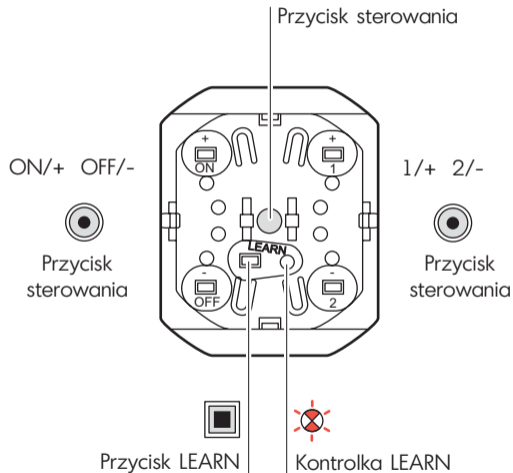

## Ustawienia fabryczne

Przy pierwszym podłączeniu do źródła zasilania, przyciskanie przycisków ON lub OFF steruje wszystkimi zdalnymi regulatorami podłączonymi do magistrali BUS.

Dzięki temu można sprawdzić działanie i podłączenie wszystkich punktów świetlnych.

Podwójne naciśnięcie na przycisk LEARN<sup>(1)</sup> anuluje tę funkcję ogólnego sterowania.

<sup>(1)</sup>Przycisk programowania lub zapamiętywania.



## Działanie

Jest to :

- **Nadajnik** : który pozwala na równoczesne sterowanie wszystkimi zdalnymi regulatorami-odbiornikami przypisanymi do niego w fazie zapamiętywania<sup>(1)</sup>.

Za pomocą przycisków ON lub OFF, można sterować punktami świetlnymi przypisanymi do odbiorników w następujący sposób :

- **włączenie** światła przez krótkie naciśnięcie przycisku ON
- **zwiększenie poziomu** natężenia światła przez długie naciśnięcie przycisku ON
- **wyłączenie światła** przez krótkie naciśnięcie przycisku OFF
- **zmniejszenie poziomu natężenia światła** przez długie naciśnięcie przycisku OFF.

Konieczny jest wyłącznie proces zapamiętywania przycisku ON, przycisk OFF programuje się automatycznie.

Za pomocą przycisków 1 i 2 :

Przyciskiem 1 można sterować punktami świetlnymi przypisanymi do odbiorników w następujący sposób :

- **włączenie scenariusza** (poziom świetlny) przez krótkie naciśnięcie przycisku 1
- **zwiększenie poziomu natężenia światła** przez długie naciśnięcie przycisku 1

Przyciskiem 2 można sterować punktami świetlnymi przypisanymi do odbiorników w następujący sposób :

- **włączenie scenariusza** (poziom świetlny) przez krótkie naciśnięcie przycisku 2
- **zmniejszenie poziomu natężenia światła** przez długie naciśnięcie przycisku 2

Aby zmieniać natężenie światła, zaleca się podłączenie tej samej grupy odbiorników do przycisków 1 i 2.

<sup>(1)</sup> **Zapamiętywanie** : procedura, która pozwala na zdefiniowanie i zapisanie scenariusza.

<sup>(2)</sup> **Scenariusz** : wszystkie komendy wykonywane równoległe na różnych odbiornikach przypisanych do nadajnika w momencie procedury zapamiętywania<sup>(1)</sup>.

## Legenda

 Kontrolka gaśnie

 Kontrolka miga powoli

 Kontrolka miga szybko

 Kontrolka błyska

## Uczenie się scenariuszy

Etap 1 : rozpoczęcie procesu uczenia (na Masterze)



Wcisnąć przycisk LEARN



Wcisnąć przycisk, który będzie uruchamiał scenariusz

Etap 2 : dodawanie urządzenia podległego do scenariusza (na SLAVE'IE)



Wcisnąć przycisk LEARN



Wcisnąć przycisk sterujący, który będzie przypisany do Mastera

W celu dodania kilku urządzeń do scenariusza, powtórzyć dla każdego z nich etapy 3 i 4.

Etap 3 : zapisywanie scenariusza (na Masterze)



Kontrolki wszystkich urządzeń gasną.  
Scenariusz został zapisany.

## Modyfikowanie scenariusza

Etap 1 : otworzyć scenariusz (na Masterze)



Wcisnąć przycisk LEARN



Wcisnąć przycisk sterujący scenariuszem

Kontrolki wszystkich urządzeń scenariusza zaczynają migać.

Etap 2 : wprowadzić zmianę stanu urządzenia podległego (na Slave'ie)



Wcisnąć przycisk LEARN



Wcisnąć przycisk LEARN

lub

W celu usunięcia urządzenia ze scenariusza należy przejść do etapu 3.

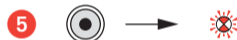

Wcisnąć przycisk sterujący, który chcemy przyporządkować

Etap 3 : zapisać scenariusz (na Masterze)



Wcisnąć przycisk LEARN

Kontrolki wszystkich urządzeń gasną.  
Scenariusz został zapisany.

## Kasowanie scenariusza

Kasowanie wszystkich scenariuszy przypisanych do przycisku sterującego (na MASTERZE)



Wcisnąć przycisk LEARN



Wcisnąć i przytrzymać 10 sekund przycisk sterujący

Effacer tous les scénarios



Wcisnąć przycisk LEARN

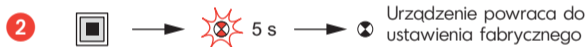

Wcisnąć i przytrzymać 10 sekund przycisk LEARN