

Circuit breaker TX³ 6000 A up to 63 A (1 module per pole)

Cat. N° (s) : 4 033 49 to 4 035 68, 4 037 12 to 4 037 78



CONTENTS	PAGE
1. Description - Use	1
2. Range	1
3. Overall dimensions	1
4. Preparation - Connection	1
5. General Characteristics	3
6. Compliance and approvals	35
7. Curves	36
8. Auxiliaries and accessories	49

1. DESCRIPTION - USE:

. Thermal-magnetic circuit breaker (MCB) for control, disconnection and protection of electrical circuits against overcurrents

Symbol:

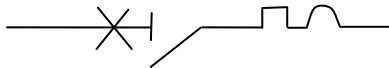

Technology:

- . Current limiting circuit-breaker
- . 1 module per pole. Each pole is 17,7 mm wide

2. RANGE

Polarity:

- . 1P / 1P+N right side / 2P / 3P / 4P

Rated currents, In:

- . B curve: 1 / 2 / 3 / 4 / 6 / 8 / 10 / 13 / 16 / 20 / 25 / 32 / 40 / 50 / 63A
- . C and D curves: 0.5 / 1 / 2 / 3 / 4 / 6 / 8 / 10 / 13 / 16 / 20 / 25 / 32 / 40 / 50 / 63A

Magnetic tripping curves:

- . B Curve (between 3 and 5 In)
- . C Curve (between 5 and 10 In)
- . D Curve (between 10 In and 17 In)

Thermal threshold according to IEC/EN 60898-1:

- . Non operating current (In_f): 1.13 In.
- . Operating current (I_f): 1.45 In.

Rated Voltage and Frequency:

- . 240 V ~ / 415 V~ - 50 / 60 Hz with standard tolerances.
- . 80 V per pole DC current.

Maximum operating voltage:

- . 440 V ~ with possible derating of the breaking capacity

Breaking capacity:

- . 6000 A in accordance with standard IEC/EN 60898-1

3. OVERALL DIMENSIONS:

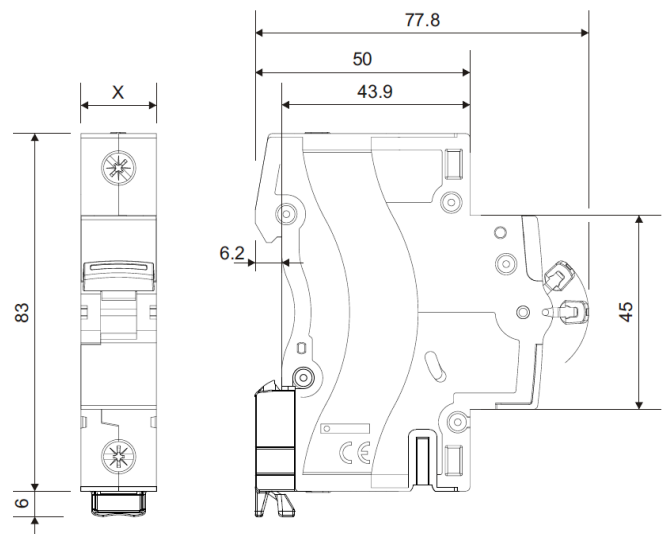

	X
1P	17.7 mm
1P+N / 2P	35.4 mm
3P	53.1 mm
4P	70.8 mm

4. PREPARATION - CONNECTION

Mounting

- . On symmetric IEC/EN 60715 or DIN 35 rail.

Operating positions:

- . Vertical Horizontal Upside down On the side

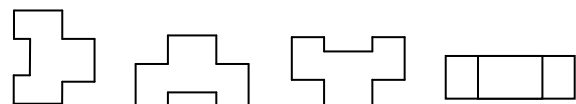

Circuit breaker TX³ 6000 A up to 63 A (1 module per pole)

Cat. N° (s) : 4 033 49 to 4 035 68, 4 037 12 to 4 037 78

4. PREPARATION - CONNECTION *(continued)*

Connection:

- . Inputs and outputs via screw terminals
- . Cage terminals, with release and captive screws
- . The location of the terminals allows supplying by pin busbar both sides and fork busbar lower side.

Module maintenance :

- . MCBs are equipped with a din rail clamp which facilitates the removal of the circuit-breaker from the din rail in case of maintenance or replacement without the need to disconnect the entire supply line.
- . A circuit breaker may be replaced in the middle of a supplied fork busbar row without disconnecting the other products.
- . This method is available for the 1 pole, 2-poles, 3-poles, 4-poles devices.

Unscrew the terminals completely

Put the clamp in the unlocking position with a screwdriver

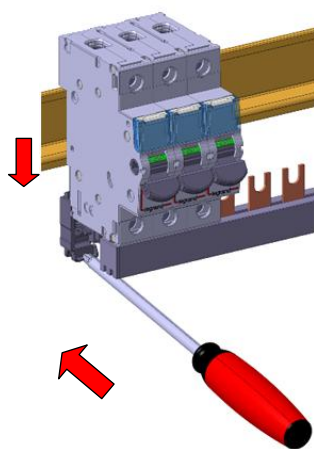

Pull the device upward

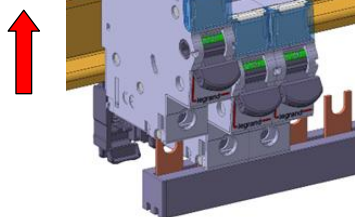

Pull the device downward in order to release it completely from the prongs of the busbar. Then pull the device forward.

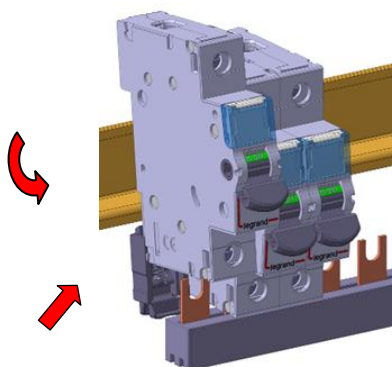

4. PREPARATION - CONNECTION *(continued)*

Power supply:

- . Either from the top or the bottom

Terminal depth:

- . 14 mm

Stripping length recommended:

- . 11 mm

Screw head:

- . Mixed, slotted and Pozidriv 2.

Tightening torque:

- . Recommended: 2.5 Nm.
- . Mini: 2 Nm. Maxi: 3 Nm.

Required tools:

- . For the terminals: Pozidriv n°2 or flat screwdriver 5.5 mm (6 mm maximum).
- . For fixing: flat screwdriver 5.5 mm (6 mm maximum).

Connectable section:

	Copper cables	
	Without ferrule	With ferrule
Rigid cable	1 x 1.5 mm ² to 35 mm ² 2 x 1.5 mm ² to 16 mm ²	-
Flexible cable	1 x 1.5 mm ² to 25 mm ² 2 x 1.5 mm ² to 10 mm ²	1 x 1.5 mm ² to 25 mm ²

Manual actuation of the MCB:

- . Ergonomic 2-position handle
- . "I-ON": Device closed
- . "O-OFF": Device open

Contact status display:

- . By marking of the handle
- "O-OFF" in white on a green background = contacts open
- "I-ON" in white on a red background = contacts closed

Sealing:

- . Possible in "Open" position (OFF) or "Close" position (ON).

Locking:

- . By 5 mm padlock (cat. N° 4 063 13) or 6 mm padlock (cat. N° 0 227 97) with padlock support (cat. N° 4 063 03).

Labelling:

- . Identification of the circuit by insertion of a label in the label holder.

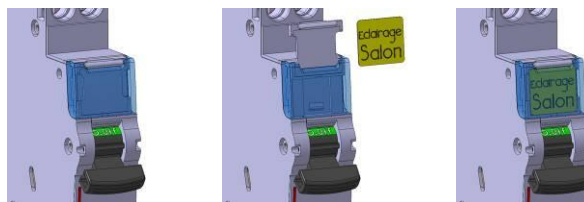

Circuit breaker TX³ 6000 A up to 63 A (1 module per pole)

Cat. N° (s) : 4 033 49 to 4 035 68, 4 037 12 to 4 037 78

5. GENERAL CHARACTERISTICS:

Neutral earthing system:

. IT, ITT, TN

Marking on the front side:

- . By permanent ink pad printing:
 - Trade name: TX³
 - Breaking curve
 - Rated current (in A)
 - I_{cn} in A rated breaking capacity in accordance with IEC/EN 60898-1 (in a box)
 - Limiting class "3" (in a square) [no for D curve]
 - Legrand reference code, and Logo 
 - Brand: Legrand.

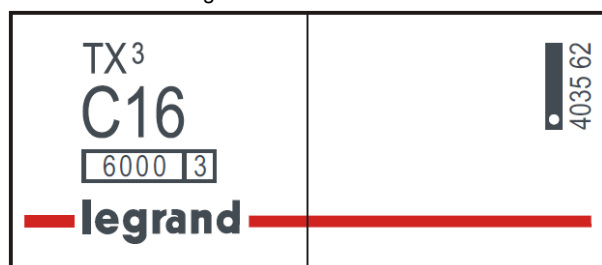

Short-circuit breaking capacity:

. Alternate current 50/60Hz, single-phase or three-phase network, in accordance with standard: IEC/EN 60898-1

Un		1P	1P+N / 2P	3P / 4P
110 V~	I_{cn}	10000 A	16000 A	-
230 V~		6000 A	10000 A	10000 A
400 V~		-	6000 A	6000 A
440 V~		-	4500 A	4500 A

110 V~	I_{cs}	75% of I_{cn}	75% of I_{cn}	75% of I_{cn}
230 V~				
400 V~				
440 V~				

Short-circuit breaking capacity of only one pole:

- . Three-phase network 220 / 380 V~ to 240 / 415 V~
 - in TN neutral system, I_{cn1} = 10 kA (under 220 to 240 V~)
 - in IT neutral system, I_{it} = 3 kA (under 380 to 415 V~)
- . Three-phase network 110 / 220 V~ to 120 / 240 V~
 - in TN neutral system, I_{cn1} = 25 kA (under 110 to 127 V~)
 - in IT neutral system, I_{it} = 6 kA (under 220 to 240 V~)

Minimum operating voltage:

. 12 V a.c. / d.c. per pole.

Pulse rated voltage:

. U_{imp} = 4 kV

Insulation rated voltage:

. U_i = 500 V

5. GENERAL CHARACTERISTICS (continued)

Pollution degree :

. 2 in accordance with standard IEC/EN 60898-1.

Electric strength:

. 2500 V

Operation at 400 Hz:

. The magnetic thresholds increase by 45%.

Load to close and to open a pole through the handle:

- . 0.1 Nm per pole to close.
- . 0.075 Nm per pole to open.

Mechanical endurance:

- . 20000 operations without load.
- . 10000 operations with load (under I_n*cos φ = 0.9).
- . 2000 operations under I_n, DC current.

Enclosure material:

- . Polyester.
- . Characteristics of this material: self extinguishing, heat and fire resistant according to EN 60898-1, glow-wire test at 960°C for external parts made of insulating material necessary to retain in position current-carrying parts and parts of protective circuit (650°C for all other external parts made of insulating material).

Average weight per pole:

. 0.150 kg.

Volume when packed:

	Volume (dm ³)
Single pole (packed per 10)	1.628
Double pole & 1P+N (packed per 5)	1.628
Triple pole / Four pole	0.720

Ambient temperatures:

- . Operation: from - 25 °C to + 70 °C
- . Storage: from - 40 °C to + 70 °C

Degree or class of protection:

- . Protection index of terminals against solid and liquid bodies: IP 20 (wired terminals), (in accordance with standards IEC 529, EN 60529 and NF C 20-010).
- . Protection index of the box against solid and liquid bodies: IP 40 (in accordance with standards IEC 529, EN 60529 and NF C 20-010).
- . Protection index against mechanical shocks: IK 02 (in accordance with standards EN 50102 and NF C 20-015).

Circuit breaker TX³ 6000 A up to 63 A (1 module per pole)

Cat. N° (s) : 4 033 49 to 4 035 68, 4 037 12 to 4 037 78

5. GENERAL CHARACTERISTICS *(continued)*

Sinusoidal vibration resistance in accordance with IEC 60068.2.6:

- . Axis: x, y, z.
- . Frequency range: 5÷100 Hz ; duration 90 minutes
- . Displacement (5÷13,2 Hz) : 1mm
- . Acceleration (13,2÷100 Hz) : 0,7 (g=9,81 m/s²)

Power dissipated per pole (W) :

. Circuit breaker B curve

In	1 A	2 A	3 A	4 A	6 A	8 A	10 A
1P÷4P	2	2	2	2	1.1	1.4	1.8

In	13 A	16 A	20 A	25 A	32 A	40 A	50 A
1P÷4P	1.9	2	2.2	2.7	3.2	4	4.5

In	63A
1P÷4P	5.5

. Circuit breaker C & D curves

In	0.5 A	1 A	2 A	3 A	4 A	6 A	8 A
1P÷4P	1.7	2	2	2	2	1.1	1.4

In	10 A	13 A	16 A	20 A	25 A	32 A	40 A
1P÷4P	1.8	1.9	2	2.2	2.7	3.2	4

In	50 A	63A
1P÷4P	4.5	5.5

. Impedance per pole (Ω) = $\frac{P \text{ dissipated}}{I_n^2}$

Circuit breaker TX³ 6000 A up to 63 A (1 module per pole)

Cat. N° (s) : 4 033 49 to 4 035 68, 4 037 12 to 4 037 78

5. GENERAL CHARACTERISTICS *(continued)*:

Derating of circuit-breakers according to ambient temperature :

. The nominal characteristics of a circuit breaker are modified according to the ambient temperature inside the cabinet or the enclosure where the circuit breaker is located.

. Reference temperature: 30 °C in accordance with IEC/EN 60898-1

In (A)	Ambient Temperature / In									
	- 25°C	- 10°C	0°C	10°C	20°C	30°C	40°C	50°C	60°C	70°C
0,5	0.62	0.6	0.57	0.55	0.52	0.5	0.47	0.42	0.40	0.38
1	1.5	1.4	1.3	1.2	1.1	1	0.9	0.8	0.7	0.6
2	2.8	2.6	2.5	2.3	2.2	2	2	1.9	1.8	1.7
3	3.8	3.6	3.5	3.3	3.2	3.0	2.9	2.8	2.7	2.6
4	4.5	4.2	4.0	3.9	3.7	3.5	3.4	3.3	3.2	3.1
6	7.5	7.0	6.6	6.4	6.2	6.0	5.8	5.6	5.4	5.3
8	9.6	9.2	8.9	8.6	8.3	8	7.8	7.5	7.3	7
10	12.5	11.5	11.1	10.7	10.3	10.0	9.7	9.3	9.0	8.7
13	16.3	15	14.3	13.9	13.4	13	12.6	12.1	11.7	11.3
16	20.0	18.7	18.0	17.3	16.6	16.0	15.4	14.7	14.1	13.5
20	25.0	23.2	22.4	21.6	20.8	20.0	19.2	18.4	17.6	16.8
25	31.5	29.5	28.3	27.2	26.0	25.0	24.0	22.7	21.7	20.7
32	41.0	37.8	36.5	34.9	33.3	32.0	30.7	29.1	27.8	26.5
40	51.0	48.0	46.0	44.0	42.0	40.0	38.0	36.0	34.0	32.0
50	64.0	60.0	57.5	55.0	52.5	50.0	47.5	45.0	42.5	40.0
63	80.6	75.6	72.5	69.9	66.1	63.0	59.8	56.1	52.9	49.7

Derating of MCB for use with fluorescent lights:

Ferromagnetic and electronic ballasts have a high inrush current for a short time. These currents can cause the tripping of circuit breakers.

At the time of the installation, it should take into account the maximum number of ballasts per circuit breaker that the manufacturers of lamps and ballasts indicate in their catalogues.

Influence of the altitude:

	≤2000 m	3000 m	4000 m	5000 m
Dielectric holding	3000 V	2500 V	2000 V	1500 V
Max operational Voltage	400 V	400 V	400 V	400 V
Derating at 30°C	none	none	none	none

Derating of MCBs function of the number of devices side by side:

When several MCBs are juxtaposed and operate simultaneously, the thermal evacuation of the poles is limited. This results in an increase in operating temperature of the circuit breakers which can cause unwanted tripping. It is recommended to apply the following coefficients to the rated currents.

Number of circuit breakers side by side	Coefficient
2 - 3	0.9
4 - 5	0.8
6 - 9	0.7
≥ 10	0.6

These values are given by the recommendation of IEC 61439-1, NF C 63421 and EN 61439-1 standards.

To avoid using these coefficients, it is necessary to allow a good ventilation and to separate the devices with 0.5 module spacing elements (cat. N° 4 063 07).

Circuit breaker TX³ 6000 A

up to 63 A (1 module per pole)

Cat. N° (s) : 4 033 49 to 4 035 68, 4 037 12 to 4 037 78

5. GENERAL CHARACTERISTICS (continued):

Coordination between circuit-breakers and fuses, three-phase network (+ neutral) 400 / 415 V~ according to IEC/EN 60947-2:

For TT or TN neutral system in 230/400 V network, to know the breaking capacity of the combination of a double pole breaker (connected between phase and neutral under 230 V) downstream of a triple-pole circuit-breaker, take the values shown in Tables 230/400 V.

		Fuse upstream									
		gG Type									
m.c.b. downstream		≤20A	25A	32A	40A	50A	63A	80A	100A	125A	160A
TX ³ 6000A B, C & D Curves	<6A	100kA	100kA	100kA	100kA	100kA	100kA	100kA	100kA	100kA	40kA
	6A	100kA	100kA	100kA	100kA	100kA	100kA	100kA	100kA	100kA	40kA
	10A	100kA	100kA	100kA	100kA	100kA	100kA	100kA	100kA	100kA	40kA
	13A	-	100kA	100kA	100kA	100kA	100kA	100kA	100kA	100kA	40kA
	16A	-	100kA	100kA	100kA	100kA	100kA	100kA	100kA	100kA	40kA
	20A	-	-	100kA	100kA	100kA	100kA	100kA	100kA	100kA	40kA
	25A	-	-	-	100kA	100kA	100kA	100kA	100kA	100kA	40kA
	32A	-	-	-	-	100kA	100kA	100kA	100kA	100kA	40kA
	40A	-	-	-	-	-	100kA	100kA	100kA	100kA	40kA
	50A	-	-	-	-	-	-	100kA	100kA	100kA	40kA
	63A	-	-	-	-	-	-	100kA	100kA	100kA	40kA

		Fuse upstream									
		aM Type									
m.c.b. downstream		≤20A	25A	32A	40A	50A	63A	80A	100A	125A	160A
TX ³ 6000A B, C & D Curves	< 6A	100kA	100kA	100kA	100kA	100kA	100kA	100kA	100kA	100kA	40kA
	6A	100kA	100kA	100kA	100kA	100kA	100kA	100kA	100kA	100kA	40kA
	10A	100kA	100kA	100kA	100kA	100kA	100kA	100kA	100kA	100kA	40kA
	13A	-	100kA	100kA	100kA	100kA	100kA	100kA	100kA	100kA	40kA
	16A	-	-	100kA	100kA	100kA	100kA	100kA	100kA	100kA	40kA
	20A	-	-	-	100kA	100kA	100kA	100kA	100kA	100kA	40kA
	25A	-	-	-	-	100kA	100kA	100kA	100kA	100kA	40kA
	32A	-	-	-	-	-	100kA	100kA	100kA	100kA	40kA
	40A	-	-	-	-	-	-	100kA	100kA	100kA	40kA
	50A	-	-	-	-	-	-	100kA	100kA	100kA	40kA
	63A	-	-	-	-	-	-	100kA	100kA	100kA	40kA

According to the curves and ratings of circuit breakers, attention to the threshold and size of upstream fuse which must necessarily be higher.

Circuit breaker TX³ 6000 A up to 63 A (1 module per pole)

Cat. N° (s) : 4 033 49 to 4 035 68, 4 037 12 to 4 037 78

5. GENERAL CHARACTERISTICS (continued):

Coordination between modular circuit-breakers, three-phase network (+ neutral) 400 / 415 V~ according to IEC/EN 60947-2:

For TT or TN neutral system in 230/400 V network, to know the breaking capacity of the combination of a double pole breaker (connected between phase and neutral under 230 V) downstream of a triple-pole circuit-breaker, take the values shown in Tables 230/400 V.

		m.c.b. upstream									
		DX ³ 6000A/10kA									
		B and C Curves					D Curve				
m.c.b. downstream		≤25A	32A	40A	50A	63A	≤25A	32A	40A	50A	63A
TX ³ 6000A B, C & D Curves	<6A	10kA	10kA	10kA	10kA	10kA	10kA	10kA	10kA	10kA	10kA
	6A	10kA	10kA	10kA	10kA	10kA	10kA	10kA	10kA	10kA	10kA
	10A	10kA	10kA	10kA	10kA	10kA	10kA	10kA	10kA	10kA	10kA
	13A	10kA	10kA	10kA	10kA	10kA	10kA	10kA	10kA	10kA	10kA
	16A	10kA	10kA	10kA	10kA	10kA	10kA	10kA	10kA	10kA	10kA
	20A	10kA	10kA	10kA	10kA	10kA	10kA	10kA	10kA	10kA	10kA
	25A	-	10kA	10kA	10kA	10kA	-	10kA	10kA	10kA	10kA
	32A	-	-	10kA	10kA	10kA	-	-	10kA	10kA	10kA
	40A	-	-	-	10kA	10kA	-	-	-	10kA	10kA
	50A	-	-	-	-	10kA	-	-	-	-	10kA
63A	-	-	-	-	-	-	-	-	-	-	

		m.c.b. upstream									
		TX ³ 10000A									
		B Curve					C Curve				
m.c.b. downstream		≤25A	32A	40A	50A	63A	≤25A	32A	40A	50A	63A
TX ³ 6000A B, C & D Curves	<6A	10kA	10kA	10kA	10kA	10kA	10kA	10kA	10kA	10kA	10kA
	6A	10kA	10kA	10kA	10kA	10kA	10kA	10kA	10kA	10kA	10kA
	10A	10kA	10kA	10kA	10kA	10kA	10kA	10kA	10kA	10kA	10kA
	13A	10kA	10kA	10kA	10kA	10kA	10kA	10kA	10kA	10kA	10kA
	16A	10kA	10kA	10kA	10kA	10kA	10kA	10kA	10kA	10kA	10kA
	20A	10kA	10kA	10kA	10kA	10kA	10kA	10kA	10kA	10kA	10kA
	25A	-	10kA	10kA	10kA	10kA	-	10kA	10kA	10kA	10kA
	32A	-	-	10kA	10kA	10kA	-	-	10kA	10kA	10kA
	40A	-	-	-	10kA	10kA	-	-	-	10kA	10kA
	50A	-	-	-	-	10kA	-	-	-	-	10kA
63A	-	-	-	-	-	-	-	-	-	-	

According to the curves and ratings of circuit breakers, attention to the magnetic threshold and to the size of upstream circuit breakers which must necessarily be higher.

Circuit breaker TX³ 6000 A up to 63 A (1 module per pole)

Cat. N° (s) : 4 033 49 to 4 035 68, 4 037 12 to 4 037 78

5. GENERAL CHARACTERISTICS *(continued)*:

Coordination between modular circuit-breakers, three-phase network (+ neutral) 400 / 415 V~ according to IEC/EN 60947-2:

For TT or TN neutral system in 230/400 V network, to know the breaking capacity of the combination of a double pole breaker (connected between phase and neutral under 230 V) downstream of a triple-pole circuit-breaker, take the values shown in Tables 230/400 V.

		m.c.b. upstream							
		DX ³ 10000/16kA							
		B and C Curves				B, C and D Curve			
m.c.b. downstream		≤25A	32A	40A	50A	63A	80A	100A	125A
TX ³ 6000A B, C & D Curves	<6A	16kA	16kA	16kA	16kA	16kA	16kA	16kA	16kA
	6A	16kA	16kA	16kA	16kA	16kA	16kA	16kA	16kA
	10A	16kA	16kA	16kA	16kA	16kA	16kA	16kA	16kA
	13A	16kA	16kA	16kA	16kA	16kA	16kA	16kA	16kA
	16A	16kA	16kA	16kA	16kA	16kA	16kA	16kA	16kA
	20A	16kA	16kA	16kA	16kA	16kA	16kA	16kA	16kA
	25A	-	16kA	16kA	16kA	16kA	16kA	16kA	16kA
	32A	-	-	16kA	16kA	16kA	16kA	16kA	16kA
	40A	-	-	-	16kA	16kA	16kA	16kA	16kA
	50A	-	-	-	-	16kA	16kA	16kA	16kA
63A	-	-	-	-	-	16kA	16kA	16kA	

		m.c.b. upstream							
		DX ³ 25kA							
		B, C and D Curves							
m.c.b. downstream		≤25A	32A	40A	50A	63A	80A	100A	125A
TX ³ 6000A B, C & D Curves	<6A	16kA	16kA	16kA	16kA	16kA	16kA	16kA	16kA
	6A	16kA	16kA	16kA	16kA	16kA	16kA	16kA	16kA
	10A	16kA	16kA	16kA	16kA	16kA	16kA	16kA	16kA
	13A	16kA	16kA	16kA	16kA	16kA	16kA	16kA	16kA
	16A	16kA	16kA	16kA	16kA	16kA	16kA	16kA	16kA
	20A	16kA	16kA	16kA	16kA	16kA	16kA	16kA	16kA
	25A	-	16kA	16kA	16kA	16kA	16kA	16kA	16kA
	32A	-	-	16kA	16kA	16kA	16kA	16kA	16kA
	40A	-	-	-	16kA	16kA	16kA	16kA	16kA
	50A	-	-	-	-	16kA	16kA	16kA	16kA
63A	-	-	-	-	-	16kA	16kA	16kA	

According to the curves and ratings of circuit breakers, attention to the magnetic threshold and to the size of upstream circuit breakers which must necessarily be higher.

Circuit breaker TX³ 6000 A up to 63 A (1 module per pole)

Cat. N° (s) : 4 033 49 to 4 035 68, 4 037 12 to 4 037 78

5. GENERAL CHARACTERISTICS *(continued)*:

Coordination between modular circuit-breakers, three-phase network (+ neutral) 400 / 415 V~ according to IEC/EN 60947-2:

For TT or TN neutral system in 230/400 V network, to know the breaking capacity of the combination of a double pole breaker (connected between phase and neutral under 230 V) downstream of a triple-pole circuit-breaker, take the values shown in Tables 230/400 V.

m.c.b. downstream		m.c.b. upstream										
		DX ³ 36kA						DX ³ 50kA				
		C Curve						B, C and D Curves				
		≤25A	32A	40A	50A	63A	80A	≤25A	32A	40A	50A	63A
TX ³ 6000A B, C & D Curves	<6A	25kA	25kA	25kA	25kA	25kA	25kA	36kA	36kA	36kA	36kA	36kA
	6A	25kA	25kA	25kA	25kA	25kA	25kA	36kA	36kA	36kA	36kA	36kA
	10A	25kA	25kA	25kA	25kA	25kA	25kA	36kA	36kA	36kA	36kA	36kA
	13A	25kA	25kA	25kA	25kA	25kA	25kA	36kA	36kA	36kA	36kA	36kA
	16A	25kA	25kA	25kA	25kA	25kA	25kA	36kA	36kA	36kA	36kA	36kA
	20A	25kA	25kA	25kA	25kA	25kA	25kA	36kA	36kA	36kA	36kA	36kA
	25A	-	25kA	25kA	25kA	25kA	25kA	-	36kA	36kA	36kA	36kA
	32A	-	-	25kA	25kA	25kA	25kA	-	-	36kA	36kA	36kA
	40A	-	-	-	25kA	25kA	25kA	-	-	-	36kA	36kA
	50A	-	-	-	-	25kA	25kA	-	-	-	-	36kA
63A	-	-	-	-	-	25kA	-	-	-	-	-	

According to the curves and ratings of circuit breakers, attention to the magnetic threshold and to the size of upstream circuit breakers which must necessarily be higher.

Circuit breaker TX³ 6000 A up to 63 A (1 module per pole)

Cat. N° (s) : 4 033 49 to 4 035 68, 4 037 12 to 4 037 78

5. GENERAL CHARACTERISTICS *(continued)*:

Coordination between modular circuit-breakers and MCCBs, three-phase network (+ neutral) 400 / 415 V~ according to IEC/EN 60947-2:

For TT or TN neutral system in 230/400 V network, to know the breaking capacity of the combination of a double pole breaker (connected between phase and neutral under 230 V) downstream of a triple-pole circuit-breaker, take the values shown in Tables 230/400 V.

m.c.b. downstream		m.c.c.b. upstream					
		DPX 125					
		16kA					
		16A	25A	40A	63A	100A	125A
TX ³ 6000A B, C & D Curves	<6A	16kA	16kA	16kA	16kA	16kA	16kA
	6A	16kA	16kA	16kA	16kA	16kA	16kA
	10A	16kA	16kA	16kA	16kA	16kA	16kA
	13A	16kA	16kA	16kA	16kA	16kA	16kA
	16A	-	16kA	16kA	16kA	16kA	16kA
	20A	-	16kA	16kA	16kA	16kA	16kA
	25A	-	-	16kA	16kA	16kA	16kA
	32A	-	-	16kA	16kA	16kA	16kA
	40A	-	-	-	16kA	16kA	16kA
	50A	-	-	-	16kA	16kA	16kA
	63A	-	-	-	-	16kA	16kA

m.c.b. downstream		m.c.c.b. upstream					
		DPX 125					
		25 – 36kA					
		16A	25A	40A	63A	100A	125A
TX ³ 6000A B, C & D Curves	<6A	25kA	25kA	25kA	25kA	25kA	25kA
	6A	25kA	25kA	25kA	25kA	25kA	25kA
	10A	25kA	25kA	25kA	25kA	25kA	25kA
	13A	25kA	25kA	25kA	25kA	25kA	25kA
	16A	-	25kA	25kA	25kA	25kA	25kA
	20A	-	25kA	25kA	25kA	25kA	25kA
	25A	-	-	25kA	25kA	25kA	25kA
	32A	-	-	25kA	25kA	25kA	25kA
	40A	-	-	-	25kA	25kA	25kA
	50A	-	-	-	25kA	25kA	25kA
	63A	-	-	-	-	25kA	25kA

According to the curves and ratings of circuit breakers, attention to the magnetic threshold and to the size of upstream circuit breakers which must necessarily be higher.

Circuit breaker TX³ 6000 A up to 63 A (1 module per pole)

Cat. N° (s) : 4 033 49 to 4 035 68, 4 037 12 to 4 037 78

5. GENERAL CHARACTERISTICS *(continued)*:

Coordination between modular circuit-breakers and MCCBs, three-phase network (+ neutral) 400 / 415 V~ according to IEC/EN 60947-2:

For TT or TN neutral system in 230/400 V network, to know the breaking capacity of the combination of a double pole breaker (connected between phase and neutral under 230 V) downstream of a triple-pole circuit-breaker, take the values shown in Tables 230/400 V.

		m.c.c.b. upstream							
		DPX ³ 160 / DPX ³ 160 + RCD							
		16kA							
m.c.b. downstream		16A	25A	40A	63A	80A	100A	125A	160A
TX ³ 6000A B, C & D Curves	<6A	16kA	16kA	16kA	16kA	16kA	16kA	16kA	16kA
	6A	16kA	16kA	16kA	16kA	16kA	16kA	16kA	16kA
	10A	16kA	16kA	16kA	16kA	16kA	16kA	16kA	16kA
	13A	16kA	16kA	16kA	16kA	16kA	16kA	16kA	16kA
	16A	-	16kA	16kA	16kA	16kA	16kA	16kA	16kA
	20A	-	16kA	16kA	16kA	16kA	16kA	16kA	16kA
	25A	-	-	16kA	16kA	16kA	16kA	16kA	16kA
	32A	-	-	16kA	16kA	16kA	16kA	16kA	16kA
	40A	-	-	-	16kA	16kA	16kA	16kA	16kA
	50A	-	-	-	16kA	16kA	16kA	16kA	16kA
	63A	-	-	-	-	16kA	16kA	16kA	16kA

		m.c.c.b. upstream							
		DPX ³ 160 / DPX ³ 160 + RCD							
		25 – 36 – 50kA							
m.c.b. downstream		16A	25A	40A	63A	80A	100A	125A	160A
TX ³ 6000A B, C & D Curves	<6A	25kA	25kA	25kA	25kA	25kA	25kA	25kA	25kA
	6A	25kA	25kA	25kA	25kA	25kA	25kA	25kA	25kA
	10A	25kA	25kA	25kA	25kA	25kA	25kA	25kA	25kA
	13A	25kA	25kA	25kA	25kA	25kA	25kA	25kA	25kA
	16A	-	25kA	25kA	25kA	25kA	25kA	25kA	25kA
	20A	-	25kA	25kA	25kA	25kA	25kA	25kA	25kA
	25A	-	-	25kA	25kA	25kA	25kA	25kA	25kA
	32A	-	-	25kA	25kA	25kA	25kA	25kA	25kA
	40A	-	-	-	25kA	25kA	25kA	25kA	25kA
	50A	-	-	-	25kA	25kA	25kA	25kA	25kA
	63A	-	-	-	-	25kA	25kA	25kA	25kA

According to the curves and ratings of circuit breakers, attention to the magnetic threshold and to the size of upstream circuit breakers which must necessarily be higher.

Circuit breaker TX³ 6000 A

up to 63 A (1 module per pole)

Cat. N° (s) : 4 033 49 to 4 035 68, 4 037 12 to 4 037 78

5. GENERAL CHARACTERISTICS *(continued)*:

Coordination between modular circuit-breakers and MCCBs, three-phase network (+ neutral) 400 / 415 V~ according to IEC/EN 60947-2:

For TT or TN neutral system in 230/400 V network, to know the breaking capacity of the combination of a double pole breaker (connected between phase and neutral under 230 V) downstream of a triple-pole circuit-breaker, take the values shown in Tables 230/400 V.

		m.c.c.b. upstream						
		DPX 250ER			DPX ³ 250 / DPX ³ 250 +RCD (Thermal-magnetic & electronic)			
		25 - 36 - 50kA			25 - 36 - 50 - 70kA			
m.c.b. downstream		100A	160A	250A	100A	160A	200A	250A
TX ³ 6000A B, C & D Curves	<6A	25kA	25kA	25kA	25kA	25kA	25kA	25kA
	6A	25kA	25kA	25kA	25kA	25kA	25kA	25kA
	10A	25kA	25kA	25kA	25kA	25kA	25kA	25kA
	13A	25kA	25kA	25kA	25kA	25kA	25kA	25kA
	16A	25kA	25kA	25kA	25kA	25k	25kA	25kA
	20A	25kA	25kA	25kA	25kA	25kA	25kA	25kA
	25A	25kA	25kA	25kA	25kA	25kA	25kA	25kA
	32A	25kA	25kA	25kA	25kA	25kA	25kA	25kA
	40A	25kA	25kA	25kA	25kA	25kA	25kA	25kA
	50A	25kA	25kA	25kA	25kA	25kA	25kA	25kA
	63A	20kA	20kA	20kA	25kA	25kA	25kA	25kA

		m.c.c.b. upstream										
		DPX / H / L 250 (Thermal-magnetic & electronic)					DPX / H / L 630 (Thermal-magnetic & electronic)					
		36 - 70 - 100kA					36 - 70 - 100kA					
m.c.b. downstream		25A	40A	63A	100A	160A	250A	250A	320A	400A	500A	630A
TX ³ 6000A B, C & D Curves	<6A	25kA	25kA	25kA	25kA	25kA	25kA	25kA	25kA	25kA	25kA	25kA
	6A	25kA	25kA	25kA	25kA	25kA	25kA	25kA	25kA	25kA	25kA	25kA
	10A	25kA	25kA	25kA	25kA	25kA	25kA	25kA	25kA	25kA	25kA	25kA
	13A	25kA	25kA	25kA	25kA	25kA	25kA	25kA	25kA	25kA	25kA	25kA
	16A	25kA	25kA	25kA	25kA	25k	25kA	25kA	25kA	25kA	25kA	25kA
	20A	25kA	25kA	25kA	25kA	25kA	25kA	25kA	25kA	25kA	25kA	25kA
	25A	-	25kA	25kA	25kA	25kA	25kA	25kA	25kA	25kA	25kA	25kA
	32A	-	25kA	25kA	25kA	25kA	25kA	25kA	25kA	25kA	25kA	25kA
	40A	-	-	25kA	25kA	25kA	25kA	20kA	20kA	20kA	20kA	20kA
	50A	-	-	25kA	25kA	25kA	25kA	16kA	16kA	16kA	16kA	16kA
	63A	-	-	-	25kA	25kA	25kA	16kA	16kA	16kA	16kA	16kA

According to the curves and ratings of circuit breakers, attention to the magnetic (or electronic) threshold and to the size of upstream circuit breakers which must necessarily be higher.

Circuit breaker TX³ 6000 A up to 63 A (1 module per pole)

Cat. N° (s) : 4 033 49 to 4 035 68, 4 037 12 to 4 037 78

5. GENERAL CHARACTERISTICS *(continued)*:

Coordination between modular circuit-breakers and MCCBs, three-phase network (+ neutral) 400 / 415 V~ according to IEC/EN 60947-2:

For TT or TN neutral system in 230/400 V network, to know the breaking capacity of the combination of a double pole breaker (connected between phase and neutral under 230 V) downstream of a triple-pole circuit-breaker, take the values shown in Tables 230/400 V.

		m.c.c.b.. upstream	
		DPX / H / L 1250 (Thermal -magnetic)	DPX / H 1600 (electronic)
		50 – 70 – 100kA	36 – 70kA
m.c.b. downstream		500 to 1250A	630 to 1600A
TX ³ 6000A B, C & D Curves	<6A	25kA	25kA
	6A	25kA	25kA
	10A	25kA	25kA
	13A	25kA	25kA
	16A	25kA	25kA
	20A	25kA	25kA
	25A	20kA	20kA
	32A	15kA	15kA
	40A	15kA	15kA
	50A	12.5kA	12.5kA
	63A	12.5kA	12.5kA

According to the curves and ratings of circuit breakers, attention to the magnetic (or electronic) threshold and to the size of upstream circuit breakers which must necessarily be higher.

Circuit breaker TX³ 6000 A up to 63 A (1 module per pole)

Cat. N° (s) : 4 033 49 to 4 035 68, 4 037 12 to 4 037 78

5. GENERAL CHARACTERISTICS *(continued)*:

Coordination between modular circuit-breakers and fuses, three-phase network (+ neutral) 230 / 240 V~ according to IEC/EN 60947-2:

m.c.b. downstream		Fuse upstream										
		gG Type										
		≤20A	25A	32A	40A	50A	63A	80A	100A	125A	160A	
TX ³ 6000A B, C & D Curves	<6A	100kA	100kA	100kA	100kA	100kA	100kA	100kA	100kA	100kA	100kA	40kA
	6A	100kA	100kA	100kA	100kA	100kA	100kA	100kA	100kA	100kA	100kA	40kA
	10A	100kA	100kA	100kA	100kA	100kA	100kA	100kA	100kA	100kA	100kA	40kA
	13A	100kA	100kA	100kA	100kA	100kA	100kA	100kA	100kA	100kA	100kA	40kA
	16A	-	100kA	100kA	100kA	100kA	100kA	100kA	100kA	100kA	100kA	40kA
	20A	-	-	100kA	100kA	100kA	100kA	100kA	100kA	100kA	100kA	40kA
	25A	-	-	-	100kA	100kA	100kA	100kA	100kA	100kA	100kA	40kA
	32A	-	-	-	-	100kA	100kA	100kA	100kA	100kA	100kA	40kA
	40A	-	-	-	-	-	100kA	100kA	100kA	100kA	100kA	40kA
	50A	-	-	-	-	-	-	100kA	100kA	100kA	100kA	40kA
	63A	-	-	-	-	-	-	100kA	100kA	100kA	100kA	40kA

m.c.b. downstream		Fuse upstream										
		aM Type										
		≤20A	25A	32A	40A	50A	63A	80A	100A	125A	160A	
TX ³ 6000A B, C & D Curves	<6A	100kA	100kA	100kA	100kA	100kA	100kA	100kA	100kA	100kA	100kA	40kA
	6A	100kA	100kA	100kA	100kA	100kA	100kA	100kA	100kA	100kA	100kA	40kA
	10A	100kA	100kA	100kA	100kA	100kA	100kA	100kA	100kA	100kA	100kA	40kA
	13A	100kA	100kA	100kA	100kA	100kA	100kA	100kA	100kA	100kA	100kA	40kA
	16A	-	100kA	100kA	100kA	100kA	100kA	100kA	100kA	100kA	100kA	40kA
	20A	-	-	100kA	100kA	100kA	100kA	100kA	100kA	100kA	100kA	40kA
	25A	-	-	-	100kA	100kA	100kA	100kA	100kA	100kA	100kA	40kA
	32A	-	-	-	-	100kA	100kA	100kA	100kA	100kA	100kA	40kA
	40A	-	-	-	-	-	100kA	100kA	100kA	100kA	100kA	40kA
	50A	-	-	-	-	-	-	100kA	100kA	100kA	100kA	40kA
	63A	-	-	-	-	-	-	100kA	100kA	100kA	100kA	40kA

According to the curves and ratings of circuit breakers, attention to the threshold and to the size of upstream fuses which must necessarily be higher.

Circuit breaker TX³ 6000 A up to 63 A (1 module per pole)

Cat. N° (s) : 4 033 49 to 4 035 68, 4 037 12 to 4 037 78

5. GENERAL CHARACTERISTICS *(continued)*:

Coordination between modular circuit-breakers, three-phase network (+ neutral) 230 / 240 V~ according to IEC/EN 60947-2:

m.c.b. downstream		m.c.b. upstream									
		DX ³ 6000A/10kA									
		B and C Curves					D Curve				
		≤25A	32A	40A	50A	63A	≤25A	32A	40A	50A	63A
TX ³ 6000A B, C & D Curves	<6A	15kA	15kA	15kA	15kA	15kA	15kA	15kA	15kA	15kA	15kA
	6A	15kA	15kA	15kA	15kA	15kA	15kA	15kA	15kA	15kA	15kA
	10A	15kA	15kA	15kA	15kA	15kA	15kA	15kA	15kA	15kA	15kA
	13A	15kA	15kA	15kA	15kA	15kA	15kA	15kA	15kA	15kA	15kA
	16A	15kA	15kA	15kA	15kA	15kA	15kA	15kA	15kA	15kA	15kA
	20A	15kA	15kA	15kA	15kA	15kA	15kA	15kA	15kA	15kA	15kA
	25A	-	15kA	15kA	15kA	15kA	-	15kA	15kA	15kA	15kA
	32A	-	-	15kA	15kA	15kA	-	-	15kA	15kA	15kA
	40A	-	-	-	15kA	15kA	-	-	-	15kA	15kA
	50A	-	-	-	-	15kA	-	-	-	-	15kA
63A	-	-	-	-	-	-	-	-	-	-	

m.c.b. downstream		m.c.b. upstream									
		TX ³ 10000A									
		B Curve					C Curve				
		≤25A	32A	40A	50A	63A	≤25A	32A	40A	50A	63A
TX ³ 6000A B, C & D Curves	<6A	15kA	15kA	15kA	15kA	15kA	15kA	15kA	15kA	15kA	15kA
	6A	15kA	15kA	15kA	15kA	15kA	15kA	15kA	15kA	15kA	15kA
	10A	15kA	15kA	15kA	15kA	15kA	15kA	15kA	15kA	15kA	15kA
	13A	15kA	15kA	15kA	15kA	15kA	15kA	15kA	15kA	15kA	15kA
	16A	15kA	15kA	15kA	15kA	15kA	15kA	15kA	15kA	15kA	15kA
	20A	15kA	15kA	15kA	15kA	15kA	15kA	15kA	15kA	15kA	15kA
	25A	-	15kA	15kA	15kA	15kA	-	15kA	15kA	15kA	15kA
	32A	-	-	15kA	15kA	15kA	-	-	15kA	15kA	15kA
	40A	-	-	-	15kA	15kA	-	-	-	15kA	15kA
	50A	-	-	-	-	15kA	-	-	-	-	15kA
63A	-	-	-	-	-	-	-	-	-	-	

According to the curves and ratings of circuit breakers, attention to the magnetic threshold and to the size of upstream circuit breakers which must necessarily be higher.

Circuit breaker TX³ 6000 A up to 63 A (1 module per pole)

Cat. N° (s) : 4 033 49 to 4 035 68, 4 037 12 to 4 037 78

5. GENERAL CHARACTERISTICS *(continued)*:

Coordination between modular circuit-breakers, three-phase network (+ neutral) 230 / 240 V~ according to IEC/EN 60947-2:

		m.c.b. upstream							
		DX ³ 10000/16kA							
		B and C Curves				B, C and D Curves			
m.c.b. downstream		≤25A	32A	40A	50A	63A	80A	100A	125A
TX ³ 6000A B, C & D Curves	<6A	25kA	25kA	25kA	25kA	25kA	25kA	25kA	25kA
	6A	25kA	25kA	25kA	25kA	25kA	25kA	25kA	25kA
	10A	25kA	25kA	25kA	25kA	25kA	25kA	25kA	25kA
	13A	25kA	25kA	25kA	25kA	25kA	25kA	25kA	25kA
	16A	25kA	25kA	25kA	25kA	25kA	25kA	25kA	25kA
	20A	25kA	25kA	25kA	25kA	25kA	25kA	25kA	25kA
	25A	-	25kA	25kA	25kA	25kA	25kA	25kA	25kA
	32A	-	-	25kA	25kA	25kA	25kA	25kA	25kA
	40A	-	-	-	25kA	25kA	25kA	25kA	25kA
	50A	-	-	-	-	25kA	25kA	25kA	25kA
63A	-	-	-	-	-	25kA	25kA	25kA	

		m.c.b. upstream							
		DX ³ 25kA							
		B, C and D Curves							
m.c.b. downstream		≤25A	32A	40A	50A	63A	80A	100A	125A
TX ³ 6000A B, C & D Curves	<6A	25kA	25kA	25kA	25kA	25kA	25kA	25kA	25kA
	6A	25kA	25kA	25kA	25kA	25kA	25kA	25kA	25kA
	10A	25kA	25kA	25kA	25kA	25kA	25kA	25kA	25kA
	13A	25kA	25kA	25kA	25kA	25kA	25kA	25kA	25kA
	16A	25kA	25kA	25kA	25kA	25kA	25kA	25kA	25kA
	20A	25kA	25kA	25kA	25kA	25kA	25kA	25kA	25kA
	25A	-	25kA	25kA	25kA	25kA	25kA	25kA	25kA
	32A	-	-	25kA	25kA	25kA	25kA	25kA	25kA
	40A	-	-	-	25kA	25kA	25kA	25kA	25kA
	50A	-	-	-	-	25kA	25kA	25kA	25kA
63A	-	-	-	-	-	25kA	25kA	25kA	

According to the curves and ratings of circuit breakers, attention to the magnetic threshold and to the size of upstream circuit breakers which must necessarily be higher.

Circuit breaker TX³ 6000 A up to 63 A (1 module per pole)

Cat. N° (s) : 4 033 49 to 4 035 68, 4 037 12 to 4 037 78

5. GENERAL CHARACTERISTICS *(continued)*:

Coordination between modular circuit-breakers, three-phase network (+ neutral) 230 / 240 V~ according to IEC/EN 60947-2:

m.c.b. downstream		m.c.b. upstream										
		DX ³ 36kA						DX ³ 50kA				
		C Curve						B, C and D Curves				
		≤25A	32A	40A	50A	63A	80A	≤25A	32A	40A	50A	63A
TX ³ 6000A B, C & D Curves	<6A	36kA	36kA	36kA	36kA	36kA	36kA	50kA	50kA	50kA	50kA	50kA
	6A	36kA	36kA	36kA	36kA	36kA	36kA	50kA	50kA	50kA	50kA	50kA
	10A	36kA	36kA	36kA	36kA	36kA	36kA	50kA	50kA	50kA	50kA	50kA
	13A	36kA	36kA	36kA	36kA	36kA	36kA	50kA	50kA	50kA	50kA	50kA
	16A	36kA	36kA	36kA	36kA	36kA	36kA	50kA	50kA	50kA	50kA	50kA
	20A	36kA	36kA	36kA	36kA	36kA	36kA	50kA	50kA	50kA	50kA	50kA
	25A	-	36kA	36kA	36kA	36kA	36kA	-	50kA	50kA	50kA	50kA
	32A	-	-	36kA	36kA	36kA	36kA	-	-	50kA	50kA	50kA
	40A	-	-	-	36kA	36kA	36kA	-	-	-	50kA	50kA
	50A	-	-	-	-	36kA	36kA	-	-	-	-	50kA
63A	-	-	-	-	-	36kA	-	-	-	-	-	

According to the curves and ratings of circuit breakers, attention to the magnetic threshold and to the size of upstream circuit breakers which must necessarily be higher.

Circuit breaker TX³ 6000 A up to 63 A (1 module per pole)

Cat. N° (s) : 4 033 49 to 4 035 68, 4 037 12 to 4 037 78

5. GENERAL CHARACTERISTICS *(continued)*:

Coordination between modular circuit-breakers and MCCBs, three-phase network (+ neutral) 400 / 415 V~ according to IEC/EN 60947-2:

For TT or TN neutral system in 230/400 V network, to know the breaking capacity of the combination of a double pole breaker (connected between phase and neutral under 230 V) downstream of a triple-pole circuit-breaker, take the values shown in Tables 230/400 V.

m.c.b. downstream		m.c.c.b. upstream					
		DPX 125					
		16kA					
		16A	25A	40A	63A	100A	125A
TX ³ 6000A B, C & D Curves	<6A	25kA	25kA	25kA	25kA	25kA	25kA
	6A	25kA	25kA	25kA	25kA	25kA	25kA
	10A	25kA	25kA	25kA	25kA	25kA	25kA
	13A	25kA	25kA	25kA	25kA	25kA	25kA
	16A	-	25kA	25kA	25kA	25kA	25kA
	20A	-	25kA	25kA	25kA	25kA	25kA
	25A	-	-	25kA	25kA	25kA	25kA
	32A	-	-	25kA	25kA	25kA	25kA
	40A	-	-	-	25kA	25kA	25kA
	50A	-	-	-	25kA	25kA	25kA
	63A	-	-	-	-	25kA	25kA

m.c.b. downstream		m.c.c.b. upstream					
		DPX 125					
		25 – 36kA					
		16A	25A	40A	63A	100A	125A
TX ³ 6000A B, C & D Curves	<6A	40kA	40kA	40kA	40kA	40kA	40kA
	6A	40kA	40kA	40kA	40kA	40kA	40kA
	10A	40kA	40kA	40kA	40kA	40kA	40kA
	13A	40kA	40kA	40kA	40kA	40kA	40kA
	16A	-	40kA	40kA	40kA	40kA	40kA
	20A	-	40kA	40kA	40kA	40kA	40kA
	25A	-	-	40kA	40kA	40kA	40kA
	32A	-	-	40kA	40kA	40kA	40kA
	40A	-	-	-	40kA	40kA	40kA
	50A	-	-	-	40kA	40kA	40kA
	63A	-	-	-	-	40kA	40kA

According to the curves and ratings of circuit breakers, attention to the magnetic threshold and to the size of upstream circuit breakers which must necessarily be higher.

Circuit breaker TX³ 6000 A up to 63 A (1 module per pole)

Cat. N° (s) : 4 033 49 to 4 035 68, 4 037 12 to 4 037 78

5. GENERAL CHARACTERISTICS *(continued)*:

Coordination between modular circuit-breakers and MCCBs, three-phase network (+ neutral) 400 / 415 V~ according to IEC/EN 60947-2:

For TT or TN neutral system in 230/400 V network, to know the breaking capacity of the combination of a double pole breaker (connected between phase and neutral under 230 V) downstream of a triple-pole circuit-breaker, take the values shown in Tables 230/400 V.

		m.c.c.b. upstream							
		DPX ³ 160 / DPX ³ 160 + RCD							
		16kA							
m.c.b. downstream		16A	25A	40A	63A	80A	100A	125A	160A
TX ³ 6000A B, C & D Curves	<6A	25kA	25kA	25kA	25kA	25kA	25kA	25kA	25kA
	6A	25kA	25kA	25kA	25kA	25kA	25kA	25kA	25kA
	10A	25kA	25kA	25kA	25kA	25kA	25kA	25kA	25kA
	13A	25kA	25kA	25kA	25kA	25kA	25kA	25kA	25kA
	16A	-	25kA	25kA	25kA	25kA	25kA	25kA	25kA
	20A	-	25kA	25kA	25kA	25kA	25kA	25kA	25kA
	25A	-	-	25kA	25kA	25kA	25kA	25kA	25kA
	32A	-	-	25kA	25kA	25kA	25kA	25kA	25kA
	40A	-	-	-	25kA	25kA	25kA	25kA	25kA
	50A	-	-	-	25kA	25kA	25kA	25kA	25kA
	63A	-	-	-	-	25kA	25kA	25kA	25kA

		m.c.c.b. upstream							
		DPX ³ 160 / DPX ³ 160 + RCD							
		25 – 36 – 50kA							
m.c.b. downstream		16A	25A	40A	63A	80A	100A	125A	160A
TX ³ 6000A B, C & D Curves	<6A	40kA	40kA	40kA	40kA	40kA	40kA	40kA	40kA
	6A	40kA	40kA	40kA	40kA	40kA	40kA	40kA	40kA
	10A	40kA	40kA	40kA	40kA	40kA	40kA	40kA	40kA
	13A	40kA	40kA	40kA	40kA	40kA	40kA	40kA	40kA
	16A	-	40kA	40kA	40kA	40kA	40kA	40kA	40kA
	20A	-	40kA	40kA	40kA	40kA	40kA	40kA	40kA
	25A	-	-	40kA	40kA	40kA	40kA	40kA	40kA
	32A	-	-	40kA	40kA	40kA	40kA	40kA	40kA
	40A	-	-	-	40kA	40kA	40kA	40kA	40kA
	50A	-	-	-	40kA	40kA	40kA	40kA	40kA
	63A	-	-	-	-	40kA	40kA	40kA	40kA

According to the curves and ratings of circuit breakers, attention to the magnetic threshold and to the size of upstream circuit breakers which must necessarily be higher.

Circuit breaker TX³ 6000 A up to 63 A (1 module per pole)

Cat. N° (s) : 4 033 49 to 4 035 68, 4 037 12 to 4 037 78

5. GENERAL CHARACTERISTICS (continued):

Coordination between modular circuit-breakers and M.C.C.Bs (Moulded Case Circuit Breakers), three-phase network (+ neutral) 230 / 240 V~ according to IEC/EN 60947-2:

		m.c.c.b. upstream						
		DPX 250ER			DPX ³ 250 / DPX ³ 250 +RCD (Thermal-magnetic & electronic)			
		25 - 36 - 50kA			25 - 36 - 50 - 70kA			
m.c.b. downstream		100A	160A	250A	100A	160A	200A	250A
TX ³ 6000A B, C & D Curves	<6A	40kA	40kA	40kA	40kA	40kA	40kA	40kA
	6A	40kA	40kA	40kA	40kA	40kA	40kA	40kA
	10A	40kA	40kA	40kA	40kA	40kA	40kA	40kA
	13A	40kA	40kA	40kA	40kA	40kA	40kA	40kA
	16A	40kA	40kA	40kA	40kA	40kA	40kA	40kA
	20A	40kA	40kA	40kA	40kA	40kA	40kA	40kA
	25A	40kA	40kA	40kA	40kA	40kA	40kA	40kA
	32A	40kA	40kA	40kA	40kA	40kA	40kA	40kA
	40A	40kA	40kA	40kA	40kA	40kA	40kA	40kA
	50A	40kA	40kA	40kA	40kA	40kA	40kA	40kA
	63A	40kA	40kA	40kA	40kA	40kA	40kA	40kA

		m.c.c.b. upstream										
		DPX / H / L 250 (Thermal-magnetic & electronic)						DPX / H / L 630 (Thermal-magnetic & electronic)				
		36 - 70 - 100kA						36 - 70 - 100kA				
m.c.b. downstream		25A	40A	63A	100A	160A	250A	250A	320A	400A	500A	630A
TX ³ 6000A B, C & D Curves	<6A	40kA	40kA	40kA	40kA	40kA	40kA	40kA	40kA	40kA	40kA	40kA
	6A	40kA	40kA	40kA	40kA	40kA	40kA	40kA	40kA	40kA	40kA	40kA
	10A	40kA	40kA	40kA	40kA	40kA	40kA	40kA	40kA	40kA	40kA	40kA
	13A	40kA	40kA	40kA	40kA	40kA	40kA	40kA	40kA	40kA	40kA	40kA
	16A	40kA	40kA	40kA	40kA	40kA	40kA	40kA	40kA	40kA	40kA	40kA
	20A	40kA	40kA	40kA	40kA	40kA	40kA	40kA	40kA	40kA	40kA	40kA
	25A	-	40kA	40kA	40kA	40kA	40kA	40kA	40kA	40kA	40kA	40kA
	32A	-	40kA	40kA	40kA	40kA	40kA	40kA	40kA	40kA	40kA	40kA
	40A	-	-	40kA	40kA	40kA	40kA	40kA	40kA	40kA	40kA	40kA
	50A	-	-	40kA	40kA	40kA	40kA	25kA	25kA	25kA	25kA	25kA
	63A	-	-	-	40kA	40kA	40kA	25kA	25kA	25kA	25kA	25kA

According to the curves and ratings of circuit breakers, attention to the magnetic threshold and to the size of upstream circuit breakers which must necessarily be higher.

Circuit breaker TX³ 6000 A up to 63 A (1 module per pole)

Cat. N° (s) : 4 033 49 to 4 035 68, 4 037 12 to 4 037 78

5. GENERAL CHARACTERISTICS *(continued)*:

Coordination between modular circuit-breakers and M.C.C.Bs (Moulded Case Circuit Breakers), three-phase network (+ neutral) 230 / 240 V~ according to IEC/EN 60947-2:

		m.c.c.b. upstream	
		DPX / H / L 1250 (Thermal-magnetic)	DPX / H 1600 (electronic)
		50 – 70 – 100kA	36 – 70kA
m.c.b. downstream		500 to 1250A	630 to 1600A
TX ³ 6000A B, C & D Curves	<6A	40kA	40kA
	6A	40kA	40kA
	10A	40kA	40kA
	13A	40kA	40kA
	16A	40kA	40kA
	20A	40kA	40kA
	25A	40kA	40kA
	32A	15kA	15kA
	40A	15kA	15kA
	50A	12,5kA	12,5kA
	63A	12,5kA	12,5kA

According to the curves and ratings of circuit breakers, attention to the magnetic (or electronic) threshold and to the size of upstream circuit breakers which must necessarily be higher.

Circuit breaker TX³ 6000 A up to 63 A (1 module per pole)

Cat. N° (s) : 4 033 49 to 4 035 68, 4 037 12 to 4 037 78

5. GENERAL CHARACTERISTICS *(continued)*

Selectivity between two levels of protection

- . The downstream circuit breaker must always have a magnetic threshold and a rated current lower than those of the upstream protection.
- . Selectivity is indicated total (T) if there is selectivity up to the value of breaking capacity (according to IEC / EN 60947-2) of the downstream circuit breaker.

Selectivity between modular circuit breakers and fuses:

- . Selectivity limit at 400 V~: values in Ampere.

m.c.b. downstream		Fuse upstream							
		gG Type							
		32A	40A	50A	63A	80A	100A	125A	160A
TX ³ 6000A B & C Curves	<6A	1300	1900	2500	4000	4600	T	T	T
	6A	1300	1900	2500	4000	4600	T	T	T
	10A	-	1600	2200	3200	3600	T	T	T
	13A	-	1400	1800	2600	3000	5600	T	T
	16A	-	1400	1800	2600	3000	5600	T	T
	20A	-	1200	1500	2200	2500	4600	T	T
	25A	-	-	1300	2000	2200	4100	5500	T
	32A	-	-	1200	1700	1900	3500	4500	T
	40A	-	-	-	-	1700	3000	4000	T
	50A	-	-	-	-	1600	2600	3500	5000
63A	-	-	-	-	-	2400	3300	5000	

m.c.b. downstream		Fuse upstream							
		gG Type							
		32A	40A	50A	63A	80A	100A	125A	160A
TX ³ 6000A D Curve	<6A	1300	1900	2500	4000	4600	T	T	T
	6A	1200	1600	2200	4000	42000	T	T	T
	10A	-	1600	2200	3200	3600	T	T	T
	13A	-	1400	1800	2600	3000	5600	T	T
	16A	-	1400	1800	2600	3000	5600	T	T
	20A	-	1200	1500	2200	2500	4600	T	T
	25A	-	-	1200	1800	2100	3700	5000	T
	32A	-	-	-	1500	1800	3000	4000	5000
	40A	-	-	-	-	1700	2600	3500	4500
	50A	-	-	-	-	1400	2000	3000	4000
63A	-	-	-	-	-	2000	3000	4000	

- . T = Total discrimination

Circuit breaker TX³ 6000 A up to 63 A (1 module per pole)

Cat. N° (s) : 4 033 49 to 4 035 68, 4 037 12 to 4 037 78

5. GENERAL CHARACTERISTICS *(continued)*

Selectivity between two levels of protection

- . The downstream circuit breaker must always have a magnetic threshold and a rated current lower than those of the upstream protection.
- . Selectivity is indicated total (T) if there is selectivity up to the value of breaking capacity (according to IEC / EN 60947-2) of the downstream circuit breaker.

Selectivity between modular circuit breakers and fuses:

- . Selectivity limit at 400 V~: values in Ampere.

m.c.b. downstream		Fuse upstream								
		aM Type								
		25A	32A	40A	50A	63A	80A	100A	125A	160A
TX ³ 6000A B & C Curves	<6A	1000	1600	2100	3200	T	T	T	T	T
	6A	1000	1600	2100	3200	T	T	T	T	T
	10A	-	1100	1700	2500	5000	T	T	T	T
	13A	-	1000	1400	2100	4000	T	T	T	T
	16A	-	1000	1400	2100	4000	T	T	T	T
	20A	-	-	1300	1800	3400	5100	T	T	T
	25A	-	-	1100	1600	3000	4500	T	T	T
	32A	-	-	-	1300	2400	3800	5000	T	T
	40A	-	-	-	-	2100	3100	4200	T	T
	50A	-	-	-	-	2000	2900	3700	T	T
63A	-	-	-	-	-	2800	3500	5500	T	

m.c.b. downstream		Fuse upstream								
		aM Type								
		25A	32A	40A	50A	63A	80A	100A	125A	160A
TX ³ 6000A D Curve	<6A	900	1400	2000	2700	5500	T	T	T	T
	6A	900	1400	2000	2700	5500	T	T	T	T
	10A	-	1100	1700	2500	5000	T	T	T	T
	13A	-	1000	1400	2100	4000	T	T	T	T
	16A	-	1000	1400	2100	4000	T	T	T	T
	20A	-	-	1300	1800	3400	5100	T	T	T
	25A	-	-	1000	1500	2700	4000	5500	T	T
	32A	-	-	-	1100	2100	3500	4700	T	T
	40A	-	-	-	-	1800	2800	4000	T	T
	50A	-	-	-	-	1800	2500	3500	5500	T
63A	-	-	-	-	-	2500	3500	5500	T	

. T = Total discrimination

Circuit breaker TX³ 6000 A up to 63 A (1 module per pole)

Cat. N° (s) : 4 033 49 to 4 035 68, 4 037 12 to 4 037 78

5. GENERAL CHARACTERISTICS *(continued)*:

Selectivity between modular circuit breakers:

. Selectivity limit at 400 V~: values in Ampere.

		m.c.b. upstream							
		TX ³ 10000A - DX ³ 6000A/10kA							
		B Curve							
m.c.b. downstream		10A	16A	20A	25A	32A	40A	50A	63A
TX ³ 6000A B & C Curves	<6A	-	64	80	100	128	160	200	252
	6A	-	64	80	100	128	160	200	252
	10A	-	-	80	100	128	160	200	252
	13A	-	-	-	100	128	160	200	252
	16A	-	-	-	-	128	160	200	252
	20A	-	-	-	-	-	160	200	252
	25A	-	-	-	-	-	-	200	252
	32A	-	-	-	-	-	-	-	252
	40A	-	-	-	-	-	-	-	-
	50A	-	-	-	-	-	-	-	-
	63A	-	-	-	-	-	-	-	-

		m.c.b. upstream							
		TX ³ 10000A - DX ³ 6000A/10kA							
		B Curve							
m.c.b. downstream		10A	16A	20A	25A	32A	40A	50A	63A
TX ³ 6000A D Curve	<6A	-	-	-	100	128	160	200	252
	6A	-	-	-	100	128	160	200	252
	10A	-	-	-	-	-	160	200	252
	13A	-	-	-	-	-	160	200	252
	16A	-	-	-	-	-	-	200	252
	20A	-	-	-	-	-	-	-	252
	25A	-	-	-	-	-	-	-	-
	32A	-	-	-	-	-	-	-	-
	40A	-	-	-	-	-	-	-	-
	50A	-	-	-	-	-	-	-	-
	63A	-	-	-	-	-	-	-	-

. T = Total discrimination

Circuit breaker TX³ 6000 A up to 63 A (1 module per pole)

Cat. N° (s) : 4 033 49 to 4 035 68, 4 037 12 to 4 037 78

5. GENERAL CHARACTERISTICS *(continued)*:

Selectivity between modular circuit breakers:

. Selectivity limit at 400 V~: values in Ampere.

		m.c.b. upstream							
		TX ³ 10000A - DX ³ 6000A/10kA							
		C Curve							
m.c.b. downstream		10A	16A	20A	25A	32A	40A	50A	63A
TX ³ 6000A B & C Curves	<6A	75	120	150	187	240	300	375	472
	6A	75	120	150	187	240	300	375	472
	10A	-	120	150	187	240	300	375	472
	13A	-	120	150	187	240	300	375	472
	16A	-	-	150	187	240	300	375	472
	20A	-	-	-	187	240	300	375	472
	25A	-	-	-	-	240	300	375	472
	32A	-	-	-	-	-	300	375	472
	40A	-	-	-	-	-	-	375	472
	50A	-	-	-	-	-	-	-	472
	63A	-	-	-	-	-	-	-	-

		m.c.b. upstream							
		TX ³ 10000A - DX ³ 6000A/10kA							
		C Curve							
m.c.b. downstream		10A	16A	20A	25A	32A	40A	50A	63A
TX ³ 6000A D Curve	<6A	-	120	150	187	240	300	375	472
	6A	-	120	150	187	240	300	375	472
	10A	-	-	150	187	240	300	375	472
	13A	-	-	-	187	240	300	375	472
	16A	-	-	-	-	240	300	375	472
	20A	-	-	-	-	-	300	375	472
	25A	-	-	-	-	-	-	375	472
	32A	-	-	-	-	-	-	-	472
	40A	-	-	-	-	-	-	-	-
	50A	-	-	-	-	-	-	-	-
	63A	-	-	-	-	-	-	-	-

. T = Total discrimination

Circuit breaker TX³ 6000 A up to 63 A (1 module per pole)

Cat. N° (s) : 4 033 49 to 4 035 68, 4 037 12 to 4 037 78

5. GENERAL CHARACTERISTICS *(continued)*:

Selectivity between modular circuit breakers:

. Selectivity limit at 400 V~: values in Ampere.

		m.c.b. upstream							
		DX ³ 6000A/10kA							
		D Curve							
m.c.b. downstream		10A	16A	20A	25A	32A	40A	50A	63A
TX ³ 6000A B & C Curves	<6A	120	192	240	300	384	480	600	756
	6A	120	192	240	300	384	480	600	756
	10A	-	192	240	300	384	480	600	756
	13A	-	-	240	300	384	480	600	756
	16A	-	-	240	300	384	480	600	756
	20A	-	-	-	300	384	480	600	756
	25A	-	-	-	-	384	480	600	756
	32A	-	-	-	-	-	480	600	756
	40A	-	-	-	-	-	-	600	756
	50A	-	-	-	-	-	-	-	756
	63A	-	-	-	-	-	-	-	-

		m.c.b. upstream							
		DX ³ 6000A/10kA							
		D Curve							
m.c.b. downstream		10A	16A	20A	25A	32A	40A	50A	63A
TX ³ 6000A D Curve	<6A	-	192	240	300	384	480	600	756
	6A	-	192	240	300	384	480	600	756
	10A	-	192	240	300	384	480	600	756
	13A	-	192	240	300	384	480	600	756
	16A	-	-	240	300	384	480	600	756
	20A	-	-	-	300	384	480	600	756
	25A	-	-	-	-	384	480	600	756
	32A	-	-	-	-	-	480	600	756
	40A	-	-	-	-	-	-	600	756
	50A	-	-	-	-	-	-	-	756
	63A	-	-	-	-	-	-	-	-

. T = Total discrimination

Circuit breaker TX³ 6000 A up to 63 A (1 module per pole)

Cat. N° (s) : 4 033 49 to 4 035 68, 4 037 12 to 4 037 78

5. GENERAL CHARACTERISTICS *(continued)*:

Selectivity between modular circuit breakers:

		m.c.b. upstream										
		DX ³ 10000A/16kA										
		B Curve										
m.c.b. downstream		10A	16A	20A	25A	32A	40A	50A	63A	80A	100A	125A
TX ³ 6000A B & C Curves	<6A	-	64	80	100	128	160	200	252	4000	T	T
	6A	-	64	80	100	128	160	200	252	4000	T	T
	10A	-	-	80	100	128	160	200	252	3000	5000	T
	13A	-	-	-	100	128	160	200	252	2500	4000	6000
	16A	-	-	-	-	128	160	200	252	2000	3600	5500
	20A	-	-	-	-	-	160	200	252	1600	3000	4000
	25A	-	-	-	-	-	-	200	252	1300	2400	3300
	32A	-	-	-	-	-	-	-	252	1000	1800	2700
	40A	-	-	-	-	-	-	-	-	800	1600	2400
	50A	-	-	-	-	-	-	-	-	800	900	1700
63A	-	-	-	-	-	-	-	-	-	900	1200	

		m.c.b. upstream										
		DX ³ 10000A/16kA										
		B Curve										
m.c.b. downstream		10A	16A	20A	25A	32A	40A	50A	63A	80A	100A	125A
TX ³ 6000A D Curve	<6A	-	-	-	100	128	160	200	252	4000	T	T
	6A	-	-	-	100	128	160	200	252	4000	T	T
	10A	-	-	-	-	-	160	200	252	3000	5000	T
	13A	-	-	-	-	-	160	200	252	2500	4000	6000
	16A	-	-	-	-	-	-	200	252	2000	3600	5500
	20A	-	-	-	-	-	-	-	252	1600	3000	4000
	25A	-	-	-	-	-	-	-	-	1300	2400	3300
	32A	-	-	-	-	-	-	-	-	-	1800	2700
	40A	-	-	-	-	-	-	-	-	-	-	2400
	50A	-	-	-	-	-	-	-	-	-	-	-
63A	-	-	-	-	-	-	-	-	-	-	-	

. T = Total discrimination

Circuit breaker TX³ 6000 A up to 63 A (1 module per pole)

Cat. N° (s) : 4 033 49 to 4 035 68, 4 037 12 to 4 037 78

5. GENERAL CHARACTERISTICS *(continued)*:

Selectivity between modular circuit breakers:

. Selectivity limit at 400 V~: values in Ampere.

		m.c.b. upstream										
		DX ³ 10000/16kA										
		C Curve										
m.c.b. downstream		10A	16A	20A	25A	32A	40A	50A	63A	80A	100A	125A
TX ³ 6000A B & C Curves	<6A	75	120	150	187	240	300	375	472	4000	T	T
	6A	75	120	150	187	240	300	375	472	4000	T	T
	10A	-	120	150	187	240	300	375	472	3000	5000	T
	13A		120	150	187	240	300	375	472	2500	4000	6000
	16A	-	-	150	187	240	300	375	472	2000	3600	5500
	20A	-	-	-	187	240	300	375	472	1600	3000	4000
	25A	-	-	-	-	240	300	375	472	1300	2400	3300
	32A	-	-	-	-	-	300	375	472	1000	1800	2700
	40A	-	-	-	-	-	-	375	472	800	1600	2400
	50A	-	-	-	-	-	-	-	472	800	900	1700
63A	-	-	-	-	-	-	-	-	650	900	1200	

		m.c.b. upstream										
		DX ³ 10000/16kA										
		C Curve										
m.c.b. downstream		10A	16A	20A	25A	32A	40A	50A	63A	80A	100A	125A
TX ³ 6000A D Curve	<6A	-	120	150	187	240	300	375	472	4000	T	T
	6A	-	120	150	187	240	300	375	472	4000	T	T
	10A	-	-	150	187	240	300	375	472	3000	5000	T
	13A		-	-	187	240	300	375	472	2500	4000	6000
	16A	-	-	-	-	240	300	375	472	2000	3600	5500
	20A	-	-	-	-	-	300	375	472	1600	3000	4000
	25A	-	-	-	-	-	-	375	472	1300	2400	3300
	32A	-	-	-	-	-	-	-	472	1000	1800	2700
	40A	-	-	-	-	-	-	-	-	800	1600	2400
	50A	-	-	-	-	-	-	-	-	-	900	1700
63A	-	-	-	-	-	-	-	-	-	-	1200	

. T = Total discrimination

Circuit breaker TX³ 6000 A up to 63 A (1 module per pole)

Cat. N° (s) : 4 033 49 to 4 035 68, 4 037 12 to 4 037 78

5. GENERAL CHARACTERISTICS *(continued)*:

Selectivity between modular circuit breakers:

. Selectivity limit at 400 V~: values in Ampere.

		m.c.b. upstream										
		DX ³ 25kA										
		B Curve										
m.c.b. downstream		10A	16A	20A	25A	32A	40A	50A	63A	80A	100A	125A
TX ³ 6000A B & C Curves	<6A	-	64	80	100	700	1200	1500	3000	4000	T	T
	6A	-	64	80	100	700	1200	1500	3000	4000	T	T
	10A	-	-	80	100	500	700	1000	1800	3000	5000	T
	13A	-	-	-	100	400	600	1200	1500	2500	4000	T
	16A	-	-	-	-	300	500	700	1300	2000	3600	5500
	20A	-	-	-	-	-	400	500	1000	1600	3000	4000
	25A	-	-	-	-	-	-	500	800	1300	2400	3300
	32A	-	-	-	-	-	-	500	600	1000	1800	2700
	40A	-	-	-	-	-	-	-	600	800	1600	2400
	50A	-	-	-	-	-	-	-	-	800	900	1700
	63A	-	-	-	-	-	-	-	-	-	900	1200

		m.c.b. upstream										
		DX ³ 25kA										
		B Curve										
m.c.b. downstream		10A	16A	20A	25A	32A	40A	50A	63A	80A	100A	125A
TX ³ 6000A D Curve	<6A	-	-	-	100	700	1200	1500	3000	4000	T	T
	6A	-	-	-	100	700	1200	1500	3000	4000	T	T
	10A	-	-	-	-	500	700	1000	1800	3000	5000	T
	13A	-	-	-	-	400	600	1200	1500	2500	4000	T
	16A	-	-	-	-	-	-	1200	1300	2000	3600	5500
	20A	-	-	-	-	-	-	-	1000	1600	3000	4000
	25A	-	-	-	-	-	-	-	-	1300	2400	3300
	32A	-	-	-	-	-	-	-	-	-	1800	2700
	40A	-	-	-	-	-	-	-	-	-	-	2400
	50A	-	-	-	-	-	-	-	-	-	-	-
	63A	-	-	-	-	-	-	-	-	-	-	-

. T = Total discrimination

Circuit breaker TX³ 6000 A up to 63 A (1 module per pole)

Cat. N° (s) : 4 033 49 to 4 035 68, 4 037 12 to 4 037 78

5. GENERAL CHARACTERISTICS *(continued)*:

Selectivity between modular circuit breakers:

. Selectivity limit at 400 V~: values in Ampere.

		m.c.b. upstream										
		DX ³ 25kA										
		C Curve										
m.c.b. downstream		10A	16A	20A	25A	32A	40A	50A	63A	80A	100A	125A
TX ³ 6000A B & C Curves	<6A	75	120	150	187	700	1200	1500	3000	4000	T	T
	6A	75	120	150	187	700	1200	1500	3000	4000	T	T
	10A	-	120	150	187	500	700	1000	1800	3000	5000	T
	13A	-	120	150	187	400	600	1200	1500	2500	4000	T
	16A	-	-	150	187	300	500	700	1300	2000	3600	5500
	20A	-	-	-	187	300	400	500	1000	1600	3000	4000
	25A	-	-	-	-	240	400	500	800	1300	2400	3300
	32A	-	-	-	-	-	300	500	600	1000	1800	2700
	40A	-	-	-	-	-	-	400	600	800	1600	2400
	50A	-	-	-	-	-	-	-	500	800	900	1700
	63A	-	-	-	-	-	-	-	-	650	900	1200

		m.c.b. upstream										
		DX ³ 25kA										
		C Curve										
m.c.b. downstream		10A	16A	20A	25A	32A	40A	50A	63A	80A	100A	125A
TX ³ 6000A D Curve	<6A	-	120	150	187	700	1200	1500	3000	4000	T	T
	6A	-	120	150	187	700	1200	1500	3000	4000	T	T
	10A	-	-	150	187	500	700	1000	1800	3000	5000	T
	13A	-	-	-	187	400	600	1200	1500	2500	4000	T
	16A	-	-	-	-	300	500	700	1300	2000	3600	5500
	20A	-	-	-	-	-	400	500	1000	1600	3000	4000
	25A	-	-	-	-	-	-	500	800	1300	2400	3300
	32A	-	-	-	-	-	-	-	600	1000	1800	2700
	40A	-	-	-	-	-	-	-	-	800	1600	2400
	50A	-	-	-	-	-	-	-	-	-	900	1700
	63A	-	-	-	-	-	-	-	-	-	-	1200

. T = Total discrimination

Circuit breaker TX³ 6000 A up to 63 A (1 module per pole)

Cat. N° (s) : 4 033 49 to 4 035 68, 4 037 12 to 4 037 78

5. GENERAL CHARACTERISTICS *(continued)*:

Selectivity between modular circuit breakers:

. Selectivity limit at 400 V~: values in Ampere.

		m.c.b. upstream										
		DX ³ 25kA										
		D Curve										
m.c.b. downstream		10A	16A	20A	25A	32A	40A	50A	63A	80A	100A	125A
TX ³ 6000A B & C Curves	<6A	120	192	240	500	700	1200	1500	3000	4000	T	T
	6A	120	192	240	500	700	1200	1500	3000	4000	T	T
	10A	-	192	240	300	500	700	1000	1800	3000	5000	T
	13A	-	-	240	300	400	600	1200	1500	2500	4000	T
	16A	-	-	240	300	384	500	700	1300	2000	3600	5500
	20A	-	-	-	300	384	480	600	1000	1600	3000	4000
	25A	-	-	-	-	384	480	600	800	1300	2400	3300
	32A	-	-	-	-	-	480	600	756	1100	1450	2700
	40A	-	-	-	-	-	-	600	756	1000	1250	2400
	50A	-	-	-	-	-	-	-	756	950	1200	1700
63A	-	-	-	-	-	-	-	-	950	1200	1500	

		m.c.b. upstream										
		DX ³ 25kA										
		D Curve										
m.c.b. downstream		10A	16A	20A	25A	32A	40A	50A	63A	80A	100A	125A
TX ³ 6000A D Curve	<6A	120	192	240	500	700	1200	1500	3000	4000	T	T
	6A	120	192	240	500	700	1200	1500	3000	4000	T	T
	10A	-	192	240	300	500	700	1000	1800	3000	5000	T
	13A	-	192	240	300	400	600	1200	1500	2500	4000	T
	16A	-	-	240	300	384	500	700	1300	2000	3600	5500
	20A	-	-	-	300	384	480	600	1000	1600	3000	4000
	25A	-	-	-	-	384	480	600	800	1300	2400	3300
	32A	-	-	-	-	-	480	600	756	1100	1450	2700
	40A	-	-	-	-	-	-	600	756	1000	1250	2400
	50A	-	-	-	-	-	-	-	756	950	1200	1700
63A	-	-	-	-	-	-	-	-	950	1200	1500	

Circuit breaker TX³ 6000 A up to 63 A (1 module per pole)

Cat. N° (s) : 4 033 49 to 4 035 68, 4 037 12 to 4 037 78

5. GENERAL CHARACTERISTICS *(continued)*:

Selectivity between modular circuit breakers:

. Selectivity limit at 400 V~: values in Ampere.

		m.c.b. upstream								
		DX ³ 36kA								
		C Curve								
m.c.b. downstream		10A	16A	20A	25A	32A	40A	50A	63A	80A
TX ³ 6000A B & C Curves	<6A	75	120	170	500	700	1200	1500	3000	4000
	6A	75	120	170	500	700	1200	1500	3000	4000
	10A	-	120	150	210	500	700	1000	1800	3000
	13A	-	120	150	200	400	600	1200	1500	2500
	16A	-	-	150	187	300	500	700	1300	2000
	20A	-	-	-	187	300	400	500	1000	1600
	25A	-	-	-	-	240	400	500	800	1300
	32A	-	-	-	-	-	300	500	600	1000
	40A	-	-	-	-	-	-	400	600	800
	50A	-	-	-	-	-	-	-	500	800
	63A	-	-	-	-	-	-	-	-	650

		m.c.b. upstream								
		DX ³ 36kA								
		C Curve								
m.c.b. downstream		10A	16A	20A	25A	32A	40A	50A	63A	80A
TX ³ 6000A D Curve	<6A	-	120	170	500	700	1200	1500	3000	4000
	6A	-	120	170	500	700	1200	1500	3000	4000
	10A	-	-	150	210	500	700	1000	1800	3000
	13A	-	-	-	200	400	600	1200	1500	2500
	16A	-	-	-	-	300	500	700	1300	2000
	20A	-	-	-	-	-	400	500	1000	1600
	25A	-	-	-	-	-	-	500	800	1300
	32A	-	-	-	-	-	-	-	600	1000
	40A	-	-	-	-	-	-	-	-	800
	50A	-	-	-	-	-	-	-	-	-
	63A	-	-	-	-	-	-	-	-	-

. T = Total discrimination

Circuit breaker TX³ 6000 A up to 63 A (1 module per pole)

Cat. N° (s) : 4 033 49 to 4 035 68, 4 037 12 to 4 037 78

5. GENERAL CHARACTERISTICS (continued):

Selectivity between modular circuit breakers:

. Selectivity limit at 400 V~: values in Ampere.

		m.c.c.b. upstream										
		DPX ³ 160 DPX ³ 160 + RCD							DPX 250ER			
		16 - 25 - 36 - 50kA							25 - 36 - 50kA			
m.c.b. downstream		16A	25A	40A	63A	80A	100A	125A	160A	100A	160A	250A
TX ³ 6000A B, C & D Curves	<6A	T	T	T	T	T	T	T	T	T	T	T
	6A	T	T	T	T	T	T	T	T	T	T	T
	10A	5000	T	T	T	T	T	T	T	T	T	T
	13A	-	T	T	T	T	T	T	T	T	T	T
	16A	-	T	T	T	T	T	T	T	T	T	T
	20A	-	5000	5000	5000	5000	6000	T	T	T	T	T
	25A	-	-	4500	4500	4500	4500	T	T	5000	T	T
	32A	-	-	-	3000	4000	4000	T	T	4000	T	T
	40A	-	-	-	3000	3000	3000	T	T	3500	T	T
	50A	-	-	-	-	3000	3000	5500	T	3000	5500	T
	63A	-	-	-	-	3000	3000	5000	T	2000	5000	5000

		m.c.c.b. upstream									
		DPX 250 / H / L (Thermal-Magnetic & electronic)						DPX ³ 250 DPX ³ 250 + RCD (Thermal-Magnetic & electronic)			
		36 - 70 - 100kA						25 - 36 - 50 - 70kA			
m.c.b. downstream		25A	40A	63A	100A	160A	250A	100A	160A	200A	250A
TX ³ 6000A B & C Curves	<6A	T	T	T	T	T	T	T	T	T	T
	6A	T	T	T	T	T	T	T	T	T	T
	10A	5000	5000	5000	T	T	T	T	T	T	T
	13A	4000	4000	4000	T	T	T	T	T	T	T
	16A	4000	4000	4000	T	T	T	T	T	T	T
	20A	-	4000	4000	T	T	T	T	T	T	T
	25A	-	3000	3000	T	T	T	T	T	T	T
	32A	-	-	2000	5000	T	T	T	T	T	T
	40A	-	-	2000	5000	T	T	T	T	T	T
	50A	-	-	-	4000	T	T	T	T	T	T
	63A	-	-	-	4000	T	T	4000	T	T	T

. T = Total discrimination

Circuit breaker TX³ 6000 A up to 63 A (1 module per pole)

Cat. N° (s) : 4 033 49 to 4 035 68, 4 037 12 to 4 037 78

5. GENERAL CHARACTERISTICS (continued):

Selectivity between M.C.Bs and M.C.C.Bs (Moulded Case Circuit Breakers):

. Selectivity limit at 400 V~: values in Ampere.

m.c.b. downstream		m.c.c.b. upstream									
		DPX 250 / H / L (Thermal-Magnetic & electronic)						DPX ³ 250 DPX ³ 250 + RCD (Thermal-Magnetic & electronic)			
		36 - 70 - 100kA						25 - 36 - 50 - 70kA			
		25A	40A	63A	100A	160A	250A	100A	160A	200A	250A
TX ³ 6000A D Curve	<6A	T	T	T	T	T	T	T	T	T	T
	6A	T	T	T	T	T	T	T	T	T	T
	10A	5000	5000	5000	T	T	T	T	T	T	T
	13A	-	4000	4000	T	T	T	T	T	T	T
	16A	-	4000	4000	T	T	T	T	T	T	T
	20A	-	4000	4000	T	T	T	T	T	T	T
	25A	-	-	3000	T	T	T	T	T	T	T
	32A	-	-	2000	5000	T	T	5000	T	T	T
	40A	-	-	-	5000	T	T	5000	T	T	T
	50A	-	-	-	4000	T	T	4000	T	T	T
	63A	-	-	-	-	T	T	-	T	T	T

m.c.b. downstream		m.c.c.b. upstream		
		DPX / H / L 630 (Thermal-Magnetic & electronic)	DPX / H / L 1250	DPX / H 1600 (electronic)
		36 - 70 - 100kA	36 - 70 - 100kA	36 - 70kA
		160 to 630A	500 to 1250A	630 to 1600A
TX ³ 6000A B, C & D Curves	<6A	T	T	T
	6A	T	T	T
	10A	T	T	T
	13A	T	T	T
	16A	T	T	T
	20A	T	T	T
	25A	T	T	T
	32A	T	T	T
	40A	T	T	T
	50A	T	T	T
	63A	T	T	T

. T = Total discrimination.

Circuit breaker TX³ 6000 A up to 63 A (1 module per pole)

Cat. N° (s) : 4 033 49 to 4 035 68, 4 037 12 to 4 037 78

6. COMPLIANCE AND APPROVALS

In accordance with standards:

- . IEC/EN 60898-1 with 6000 A breaking capacity
- . IEC/EN 60947-2 with 6 kA breaking capacity
- . CEE guidelines : 73/23/CEE + 93/68/CEE
- . Legrand circuit-breakers can be used under the conditions of use as defined by EN/IEC 60947.
- . The performance of circuit breakers can be influenced by particular climates: hot dry, cold dry, hot humid, salt fog atmosphere

Classification according to Annex Q (standard IEC/EN 60947-1) :

- . Category C with a range test temperature -25 °C / +70 °C
- . Salt fog atmosphere according IEC 60068-2-52

Environment respect – Compliance with CEE directives:

- . Compliance with Directive 2002/95/EC of 27/01/03 called "RoHS" which provides for the banning of hazardous substances such as lead, mercury, cadmium, hexavalent chromium, brominated flame retardants polybrominated biphenyls (PBBs) and polybrominated diphenyl ethers (PBDEs) from 1st July 2006
- . Compliance with Directive 91/338/CEE of 18/06/91 and Decree 94-647 of 27/07/04

Plastic materials :

- . Halogens-free plastic materials.
- . Marking of parts according to ISO 11469 and ISO 1043.

Packaging:

- . Design and manufacture of packaging in accordance with Decree 98-638 of 07.20.98 and Directive 94/62/EC

Circuit breaker TX³ 6000 A up to 63 A (1 module per pole)

Cat. N° (s) : 4 033 49 to 4 035 68, 4 037 12 to 4 037 78

7. CHARACTERISTIC CURVES

Limiting current curve: circuit breakers B, C and D curves

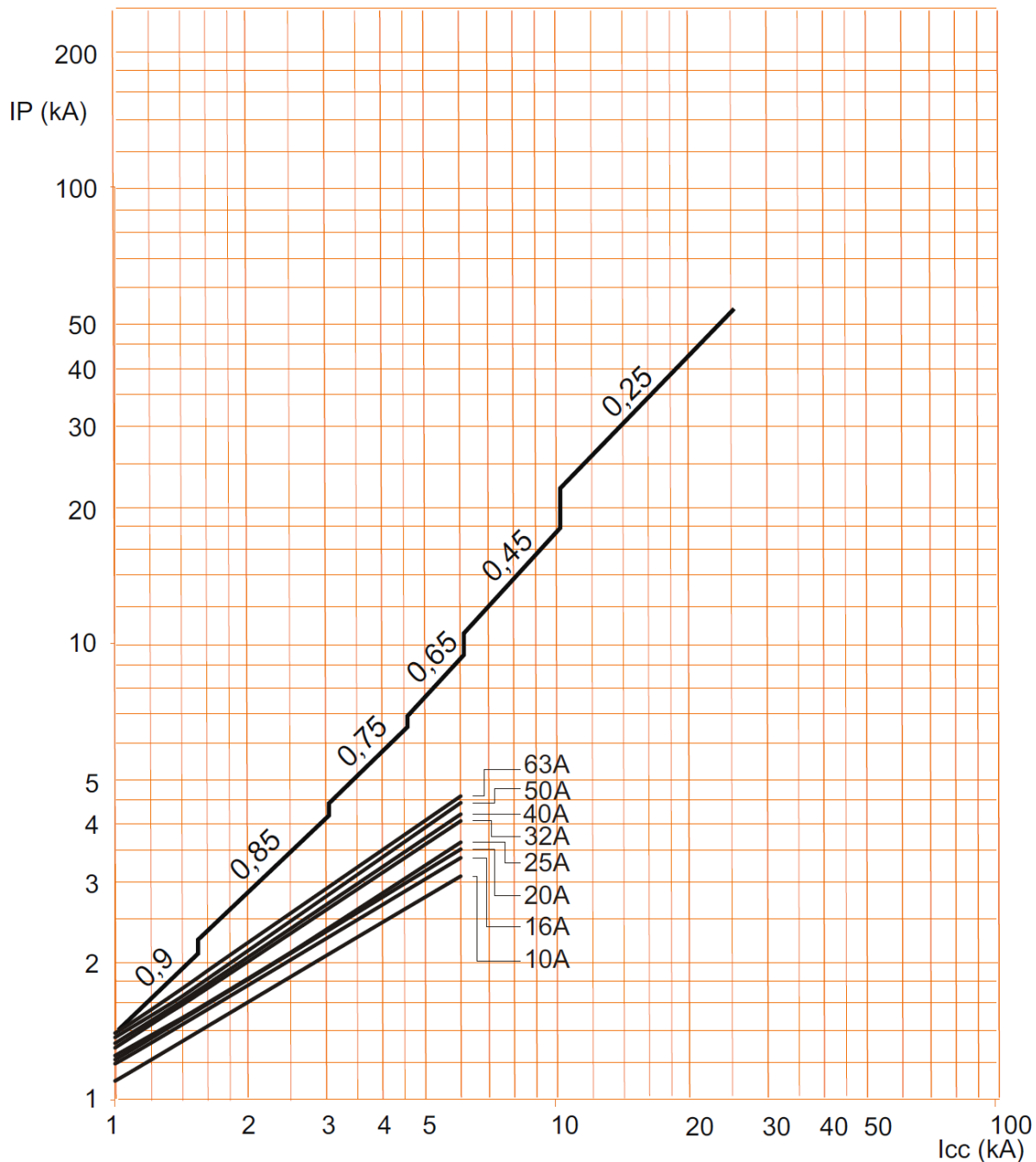

- . I_{cc} = Square value of symmetric component of the short circuit current (kA).
- . IP = Max peak value (kA)

Circuit breaker TX³ 6000 A up to 63 A (1 module per pole)

Cat. N° (s) : 4 033 49 to 4 035 68, 4 037 12 to 4 037 78

7. CHARACTERISTIC CURVES *(continued)*

Operating characteristic of circuit breakers B curve:

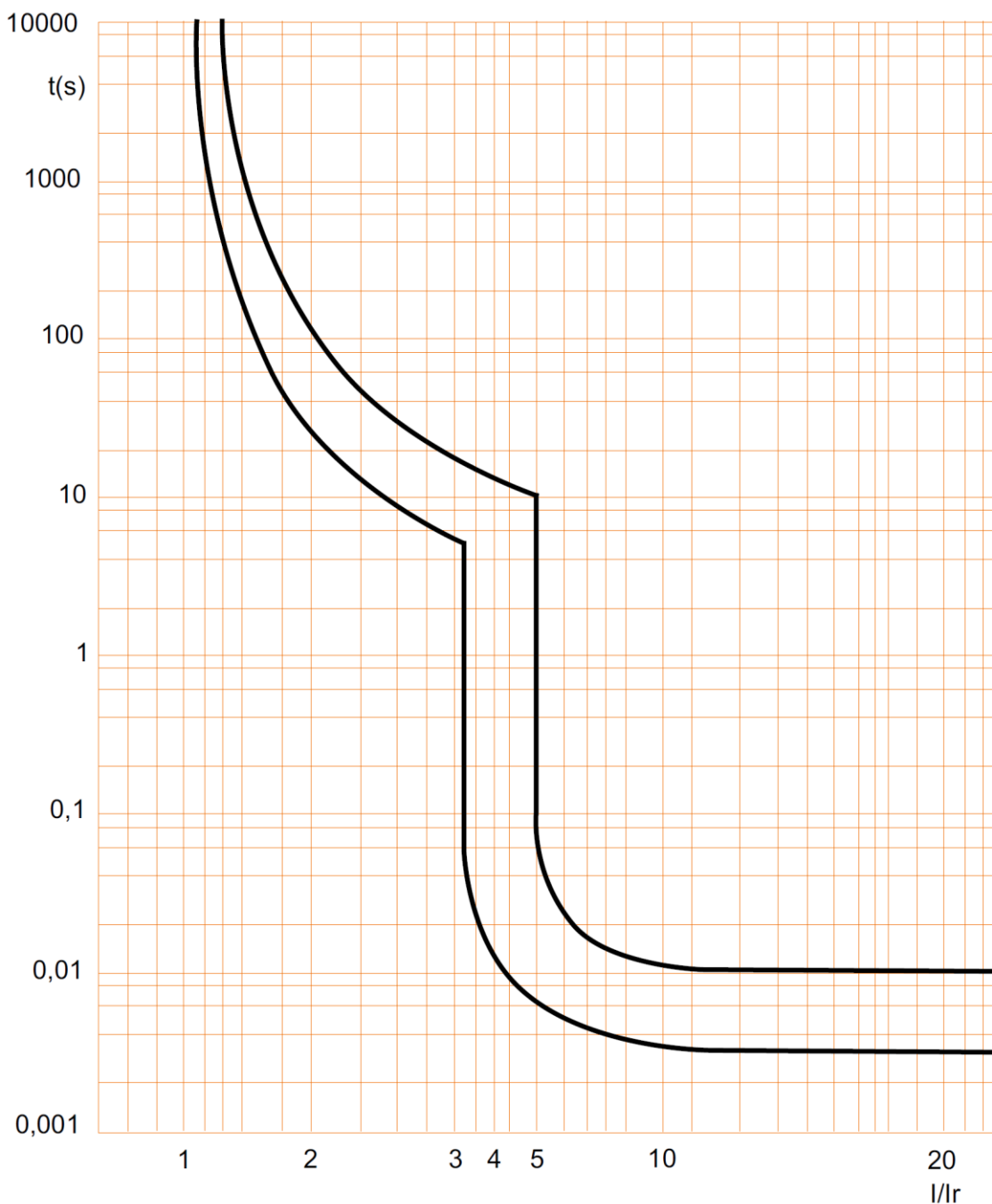

Circuit breaker TX³ 6000 A up to 63 A (1 module per pole)

Cat. N° (s) : 4 033 49 to 4 035 68, 4 037 12 to 4 037 78

7. CHARACTERISTIC CURVES *(continued)*

. Limiting thermal energy curve of circuit breakers B curve, 2P (230 V~ / 50 Hz):

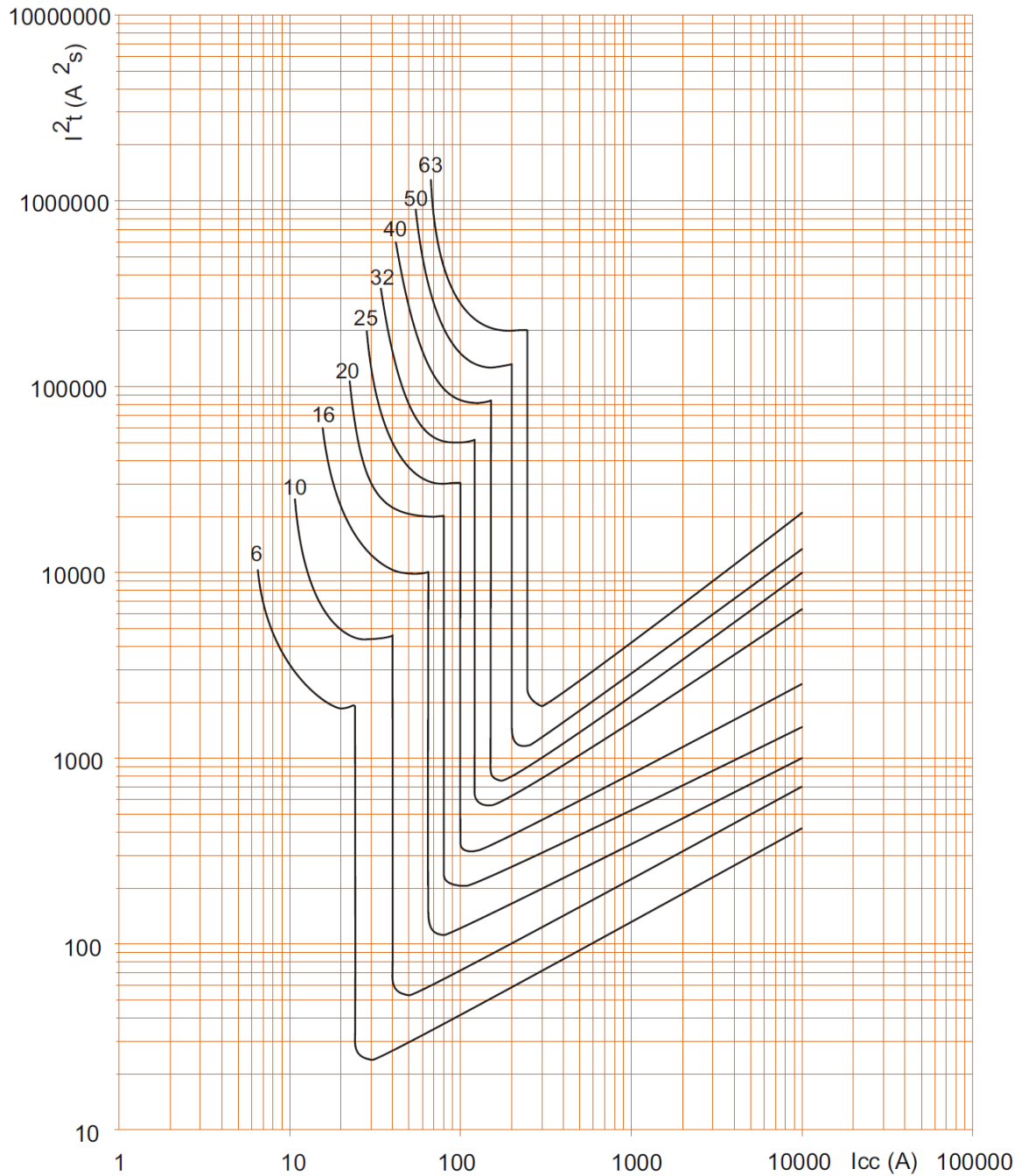

. I_{cc} = Square value of symmetric component of the short circuit current (kA).

. I^2t = Thermal energy limited (A^2s).

Circuit breaker TX³ 6000 A up to 63 A (1 module per pole)

Cat. N° (s) : 4 033 49 to 4 035 68, 4 037 12 to 4 037 78

7. CHARACTERISTIC CURVES (continued)

. Limiting thermal energy curve of circuit breakers B curve, 2P (400 V~ / 50 Hz) :

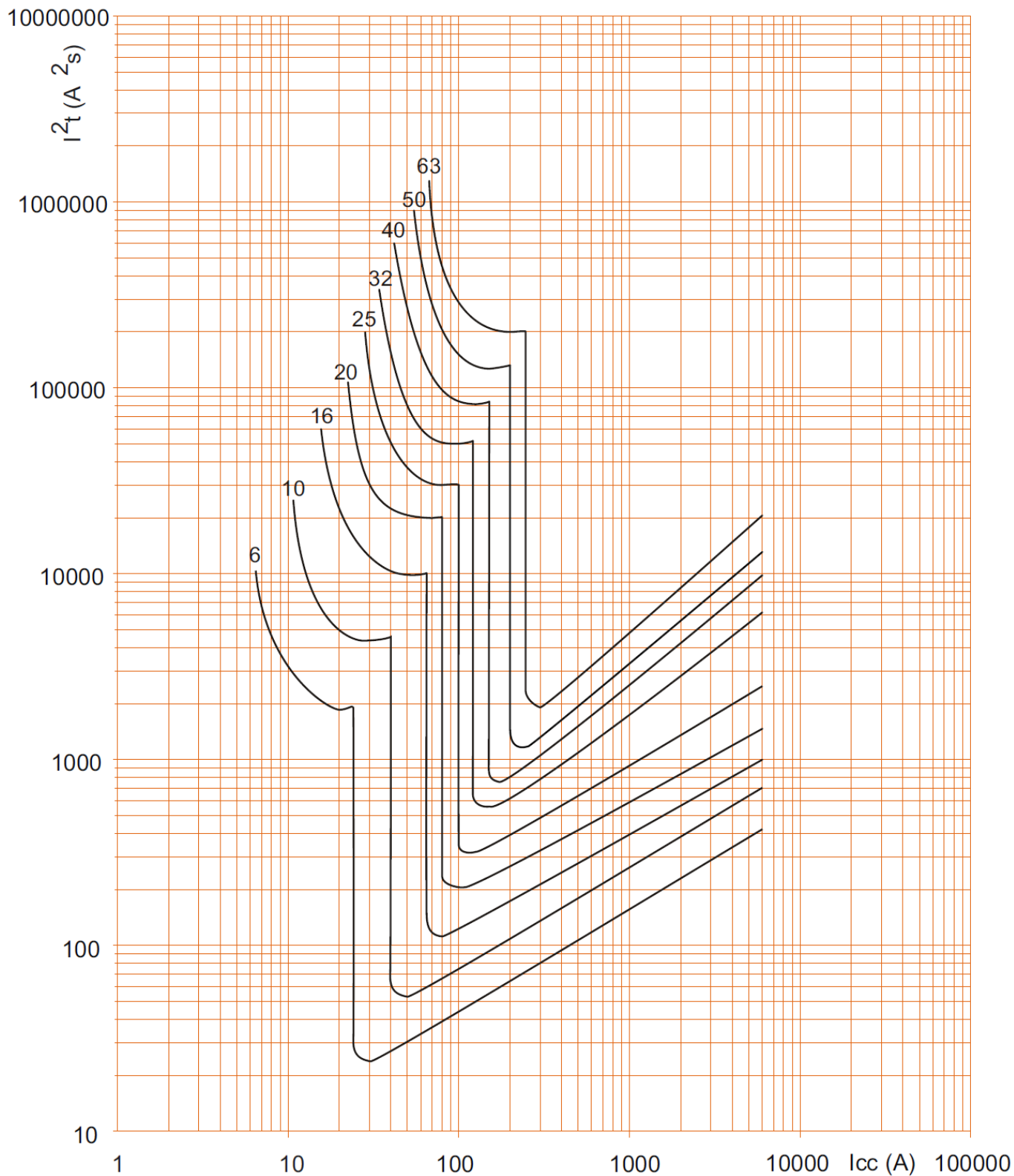

. I_{cc} = Square value of symmetric component of the short circuit current (kA).

. I^2t = Thermal energy limited (A^2s).

Circuit breaker TX³ 6000 A up to 63 A (1 module per pole)

Cat. N° (s) : 4 033 49 to 4 035 68, 4 037 12 to 4 037 78

7. CHARACTERISTIC CURVES *(continued)*

. Limiting thermal energy curve of circuit breakers B curve, 1P / 3P / 4P (400 V~ / 50 Hz) :

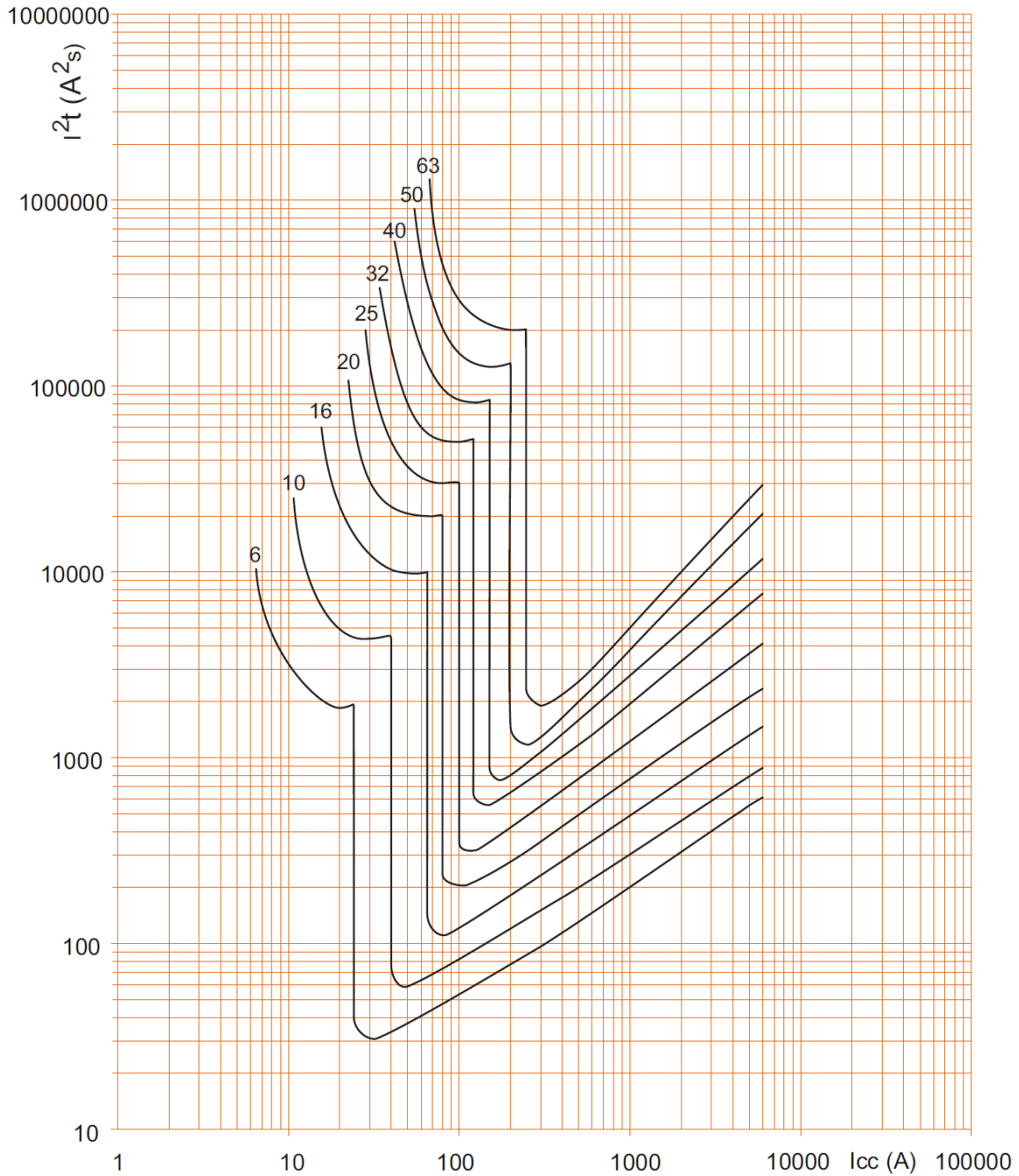

. I_{cc} = Square value of symmetric component of the short circuit current (kA).

. I²t = Thermal energy limited (A²s).

Circuit breaker TX³ 6000 A up to 63 A (1 module per pole)

Cat. N° (s) : 4 033 49 to 4 035 68, 4 037 12 to 4 037 78

7. CHARACTERISTIC CURVES *(continued)*

Operating characteristic of circuit breakers C curve:

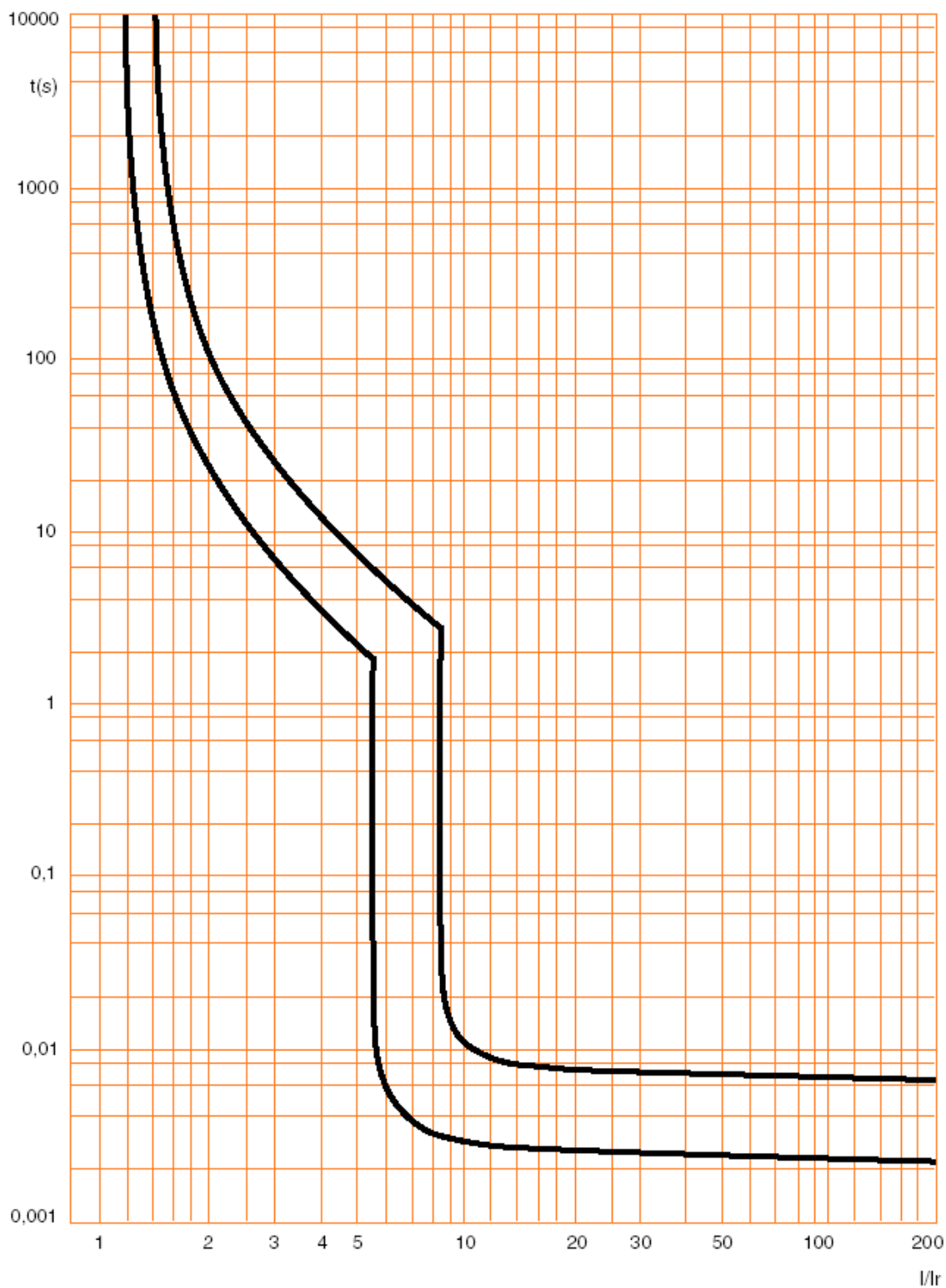

Circuit breaker TX³ 6000 A up to 63 A (1 module per pole)

Cat. N° (s) : 4 033 49 to 4 035 68, 4 037 12 to 4 037 78

7. CHARACTERISTIC CURVES *(continued)*

. Limiting thermal energy curve of circuit breakers C curve, 2P (230 V~ / 50 Hz) :

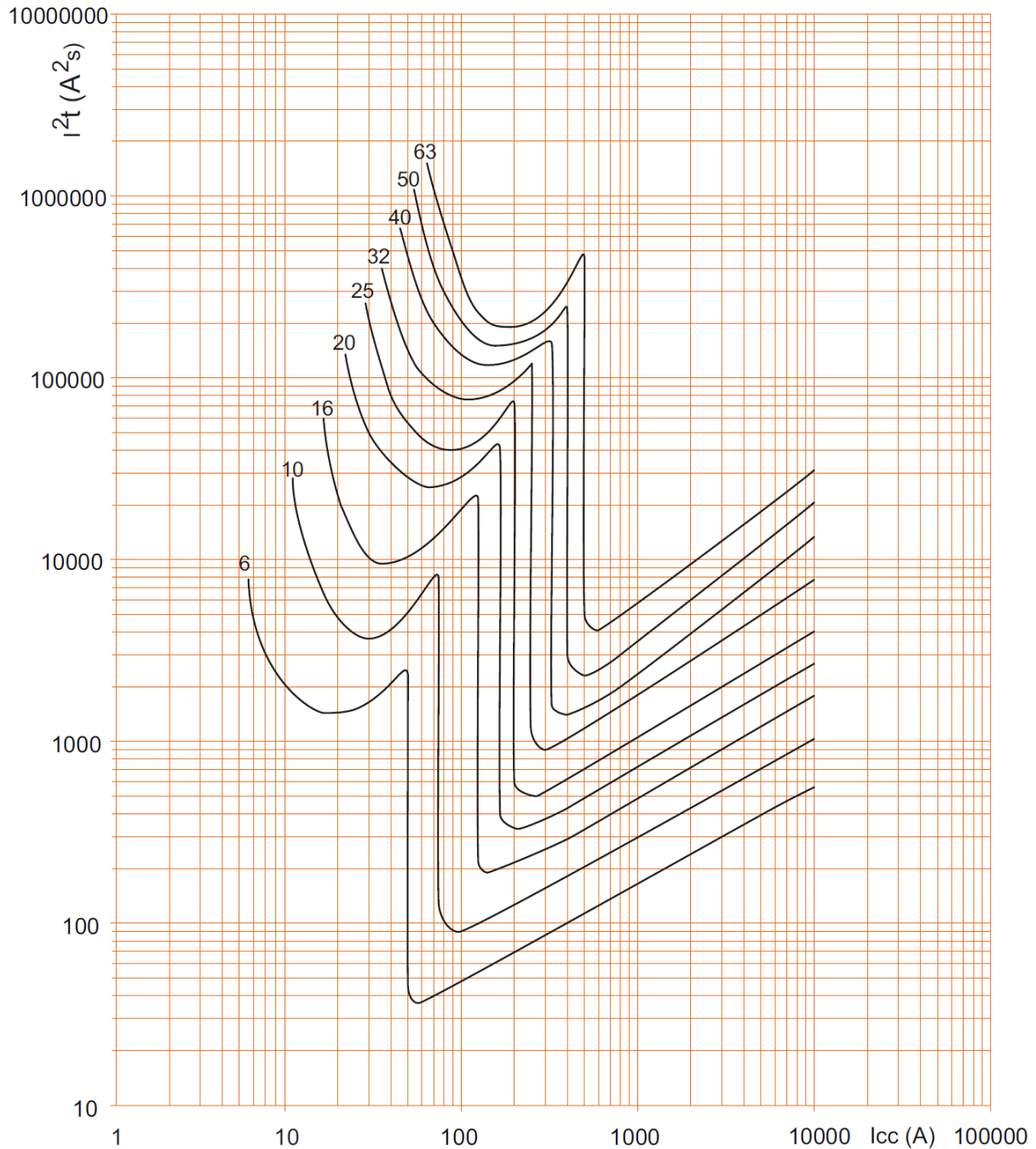

. I_{cc} = Square value of symmetric component of the short circuit current (kA).

. I^2t = Thermal energy limited (A²s).

Circuit breaker TX³ 6000 A up to 63 A (1 module per pole)

Cat. N° (s) : 4 033 49 to 4 035 68, 4 037 12 to 4 037 78

7. CHARACTERISTIC CURVES *(continued)*

. Limiting thermal energy curve of circuit breakers C curve, 2P (400 V~ / 50 Hz) :

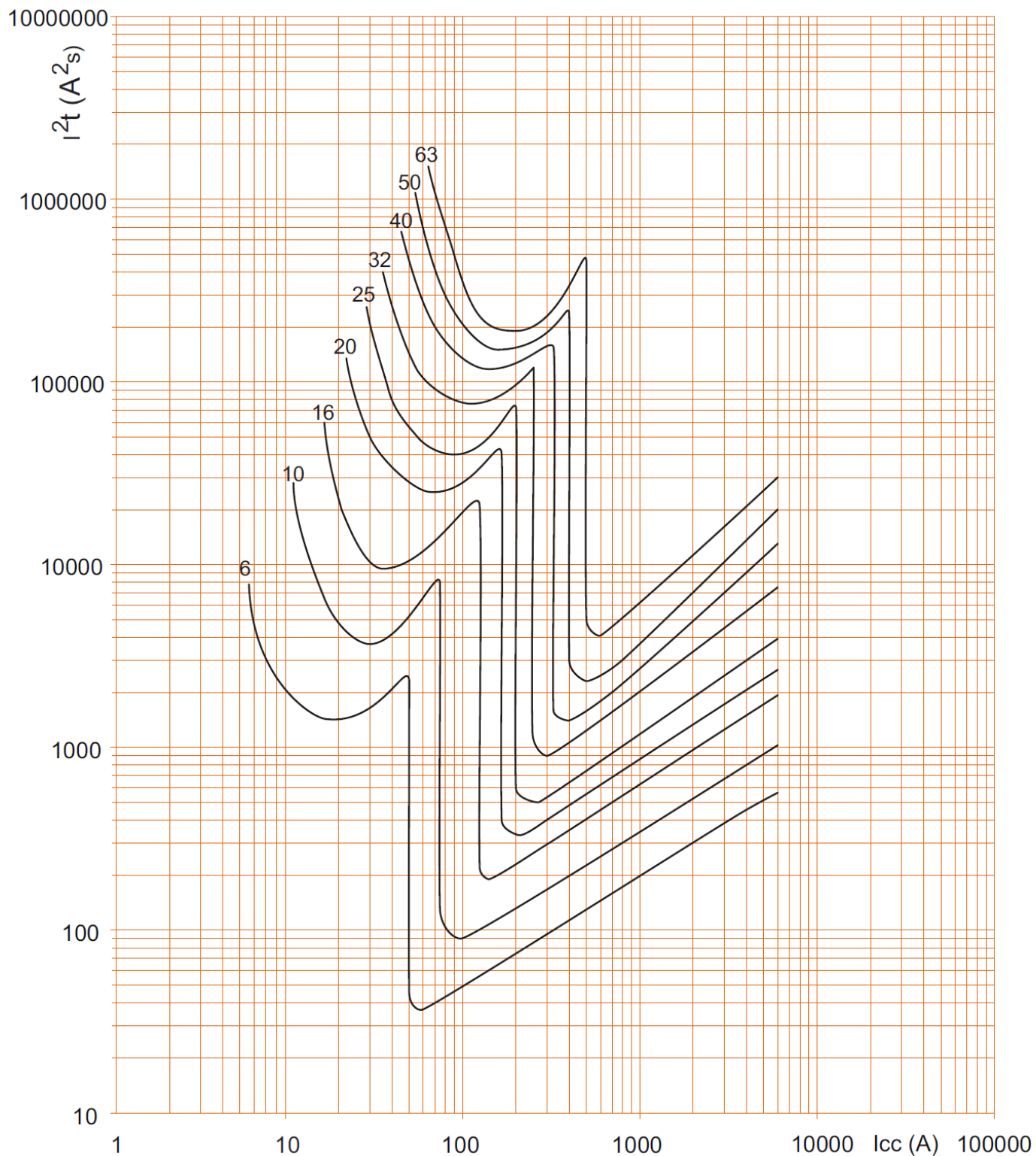

. I_{cc} = Square value of symmetric component of the short circuit current (kA).

. I^2t = Thermal energy limited (A^2s).

Circuit breaker TX³ 6000 A up to 63 A (1 module per pole)

Cat. N° (s) : 4 033 49 to 4 035 68, 4 037 12 to 4 037 78

7. CHARACTERISTIC CURVES *(continued)*

. Limiting thermal energy curve of circuit breakers C curve, 1P / 3P / 4P (400 V~ / 50 Hz) :

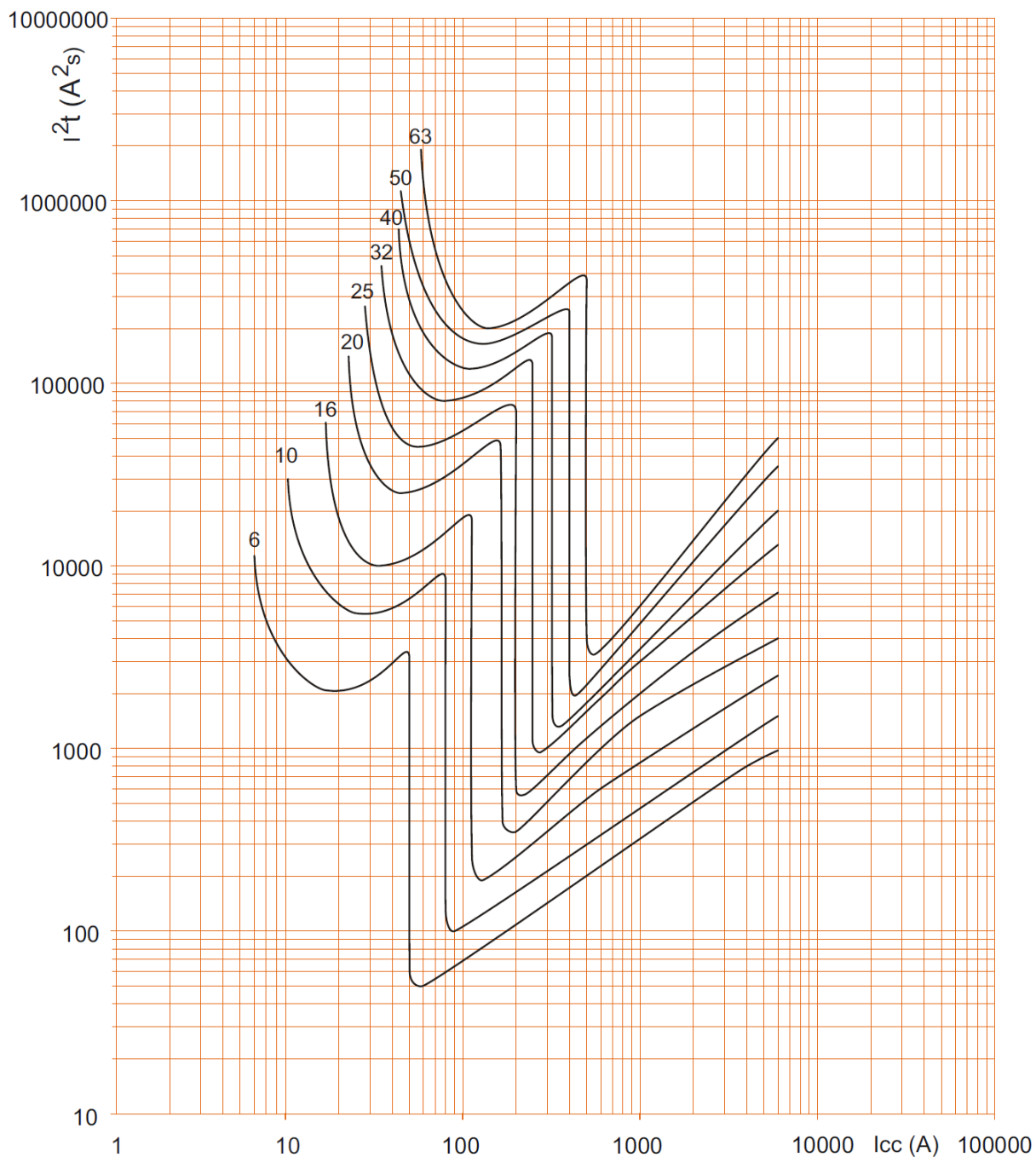

. I_{cc} = Square value of symmetric component of the short circuit current (kA).

. I^2t = Thermal energy limited (A^2s).

Circuit breaker TX³ 6000 A up to 63 A (1 module per pole)

Cat. N° (s) : 4 033 49 to 4 035 68, 4 037 12 to 4 037 78

7. CHARACTERISTIC CURVES (continued)

Operating characteristic of circuit breakers D curve :

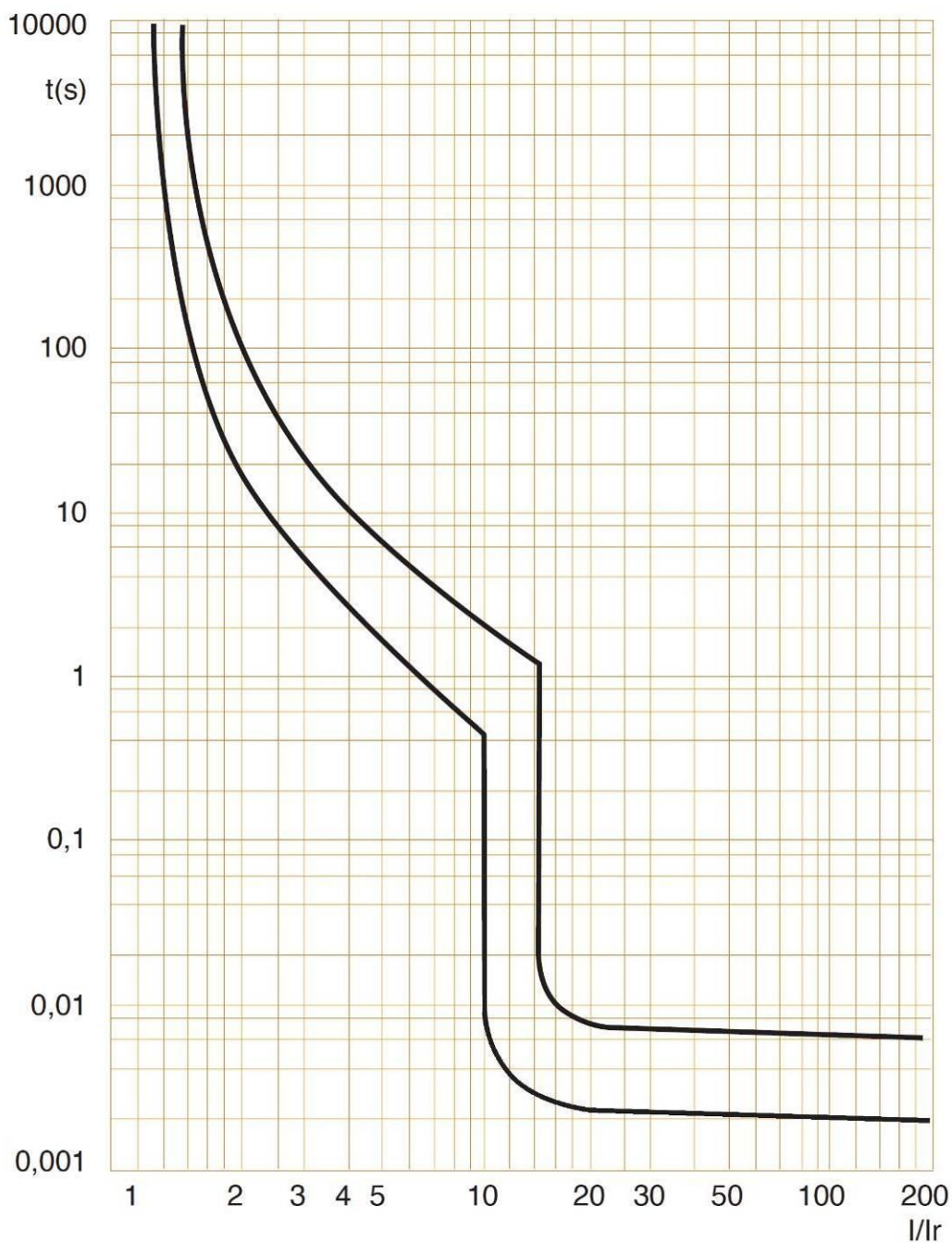

Circuit breaker TX³ 6000 A up to 63 A (1 module per pole)

Cat. N° (s) : 4 033 49 to 4 035 68, 4 037 12 to 4 037 78

7. CHARACTERISTIC CURVES *(continued)*

. Limiting thermal energy curve of circuit breakers D curve , 2P (230V~ / 50Hz) :

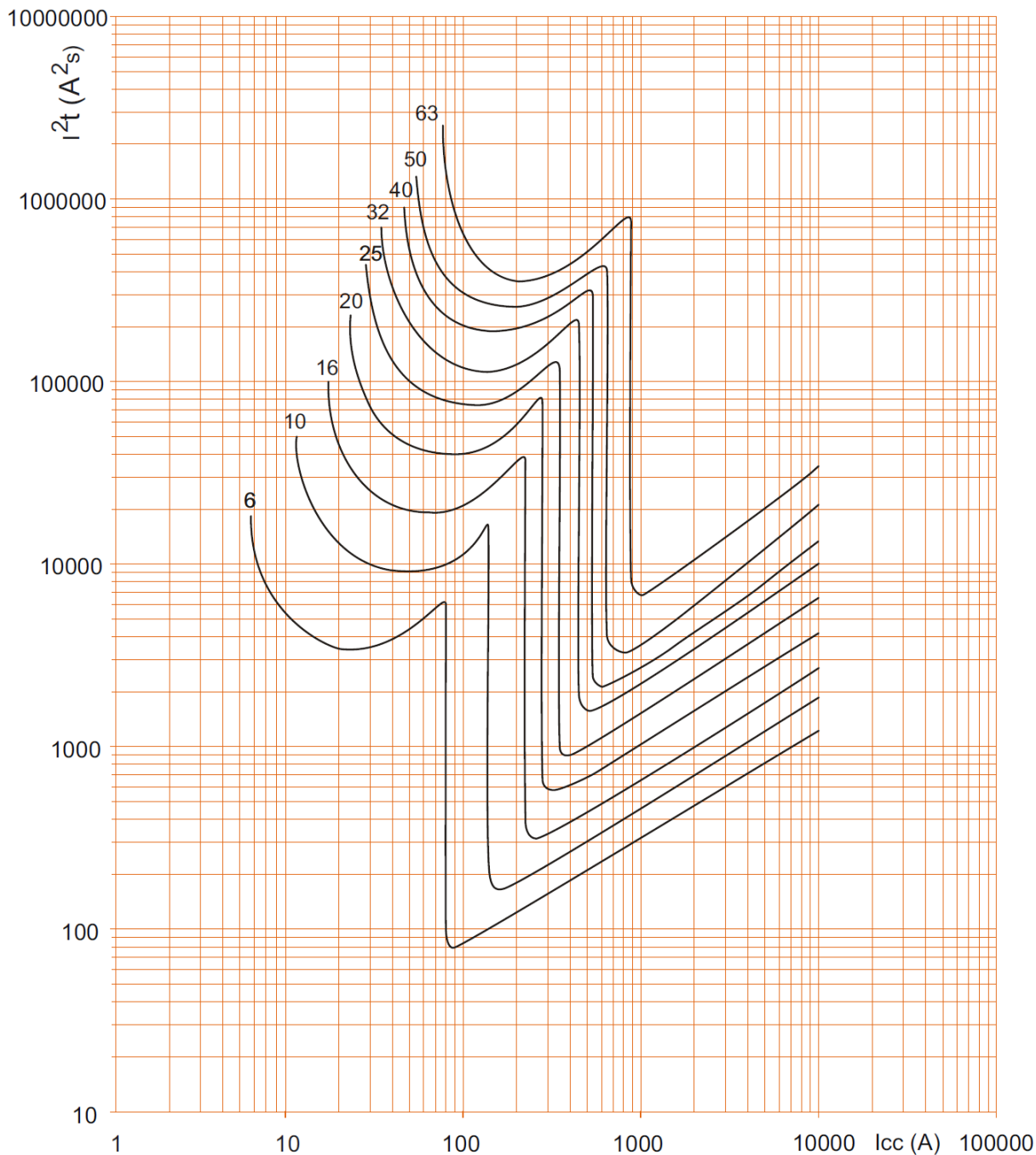

. I_{cc} = Square value of symmetric component of the short circuit current (kA).

. I^2t = Thermal energy limited (A^2s).

Circuit breaker TX³ 6000 A up to 63 A (1 module per pole)

Cat. N° (s) : 4 033 49 to 4 035 68, 4 037 12 to 4 037 78

7. CHARACTERISTIC CURVES *(continued)*

. Limiting thermal energy curve of circuit breakers D curve, 2P (400V~ / 50Hz) :

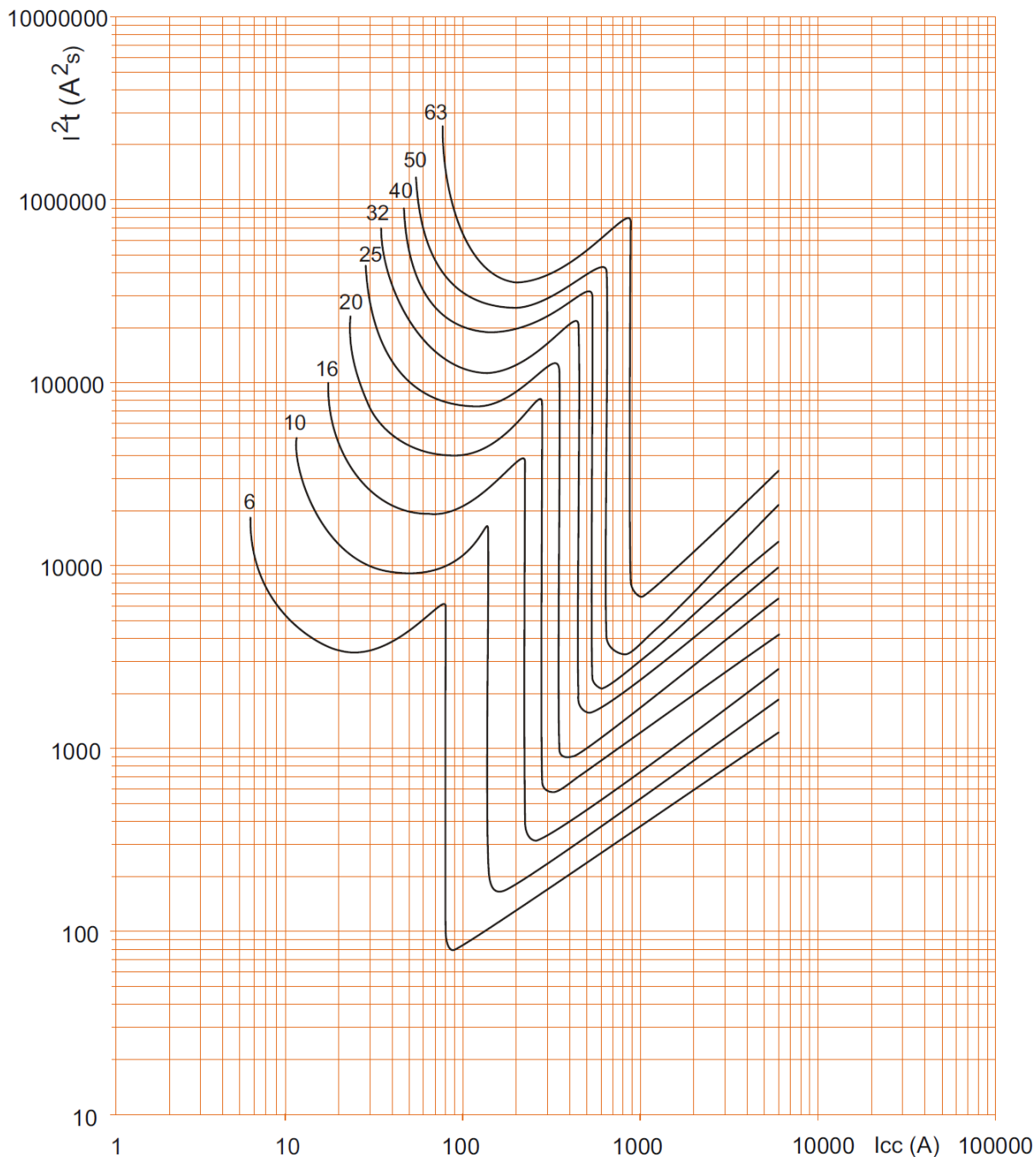

. I_{cc} = Square value of symmetric component of the short circuit current (kA).

. I^2t = Thermal energy limited (A^2s).

Circuit breaker TX³ 6000 A up to 63 A (1 module per pole)

Cat. N° (s) : 4 033 49 to 4 035 68, 4 037 12 to 4 037 78

7. CHARACTERISTIC CURVES *(continued)*

. Limiting thermal energy curve of circuit breakers D curve, 1P / 3P / 4P (400V~ / 50Hz) :

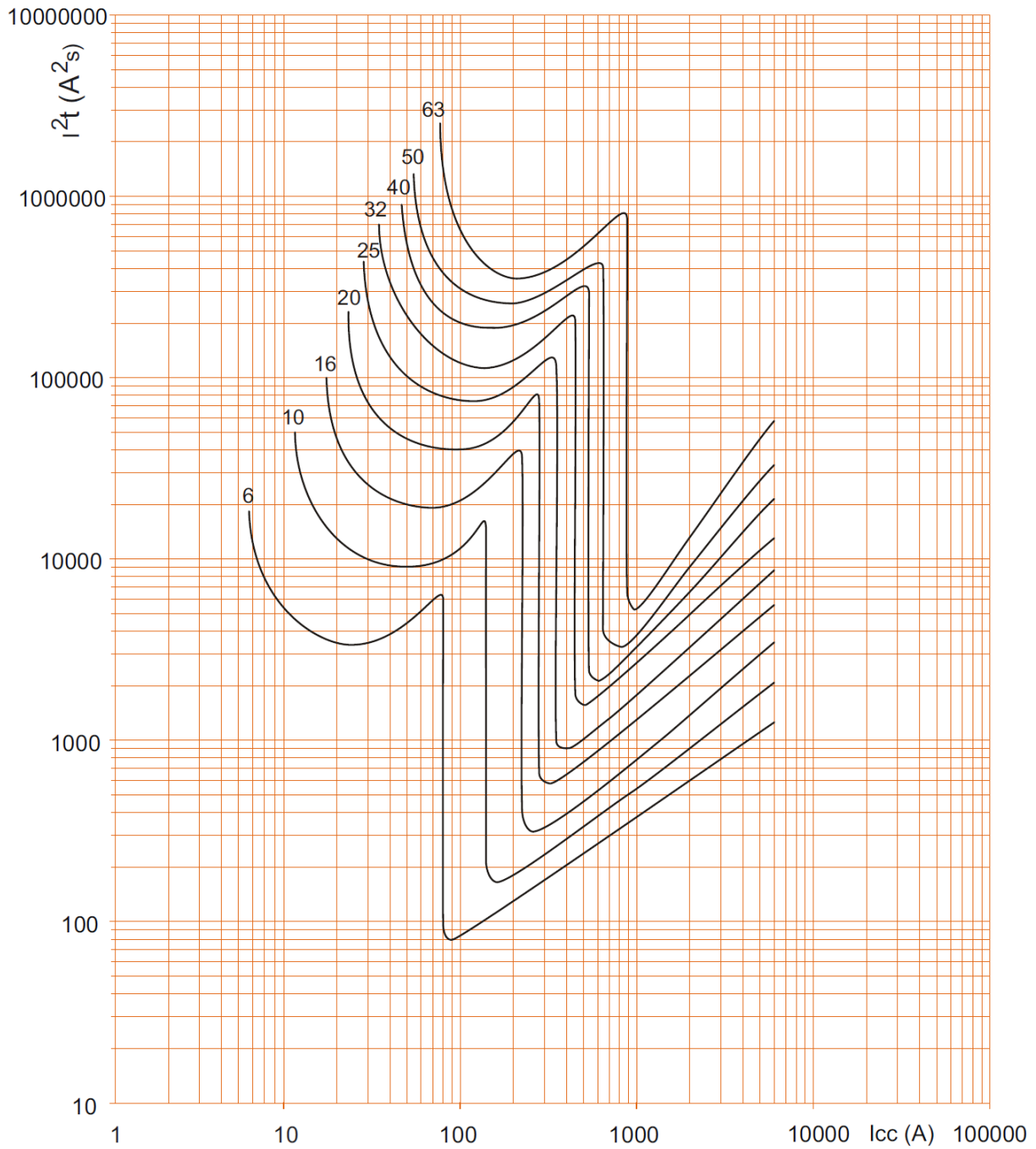

. I_{cc} = Square value of symmetric component of the short circuit current (kA).

. I^2t = Thermal energy limited (A^2s).

Circuit breaker TX³ 6000 A up to 63 A (1 module per pole)

Cat. N° (s) : 4 033 49 to 4 035 68, 4 037 12 to 4 037 78

8. AUXILIARIES AND ACCESSORIES

Wiring accessories:

- . Fork busbar or prong busbar
- . Sealable screw cover (cat n° 4 063 04).
- . Dispatcher row Lexiclic
- . Dispatcher row HX³.

Signalling auxiliaries - fork busbar adapted:

- . Auxiliary contact (½ module – cat n° 4 062 50).
- . Fault signalling changeover switch (½ module – cat n° 4 062 52).
- . Auxiliary contact modifiable in default signal (½ module – cat n° 4 062 56).
- . Auxiliary contact + fault signalling switch - can be modified to 2 auxiliary contacts (1 module - cat n° 4 062 64).

Signalling auxiliaries - prong busbar adapted:

- . Auxiliary contact (½ module – cat n° 4 062 58).
- . Fault signalling changeover switch (½ module – cat n° 4 062 60).
- . Auxiliary contact modifiable in default signal (½ module – cat n° 4 062 62).
- . Auxiliary contact + fault signalling switch - can be modified to 2 auxiliary contacts (1 module - cat n° 4 062 66).

Control auxiliaries:

- . Shunt releases (1 module - cat n° 4 062 76 /78)
- . Under voltage release (1 module - cat n° 4 062 80 /82)
- . Autonomous shunt trip for NC push-button (1 module - cat n° 4 062 84 / 87).

Motor driven control modules

- . Motor driven control module (1 module – cat n° 4 062 91)
- . Motor driven control module with automatic resetting integrated (2 modules – cat n° 4 062 93 /95)

Front external rotary handle

- . Black handle (cat nat n° 4 063 19)
- . Yellow and red handle (cat n° 4 063 20)

Possible combinations of m.c.b and auxiliaries:

- . Only the association of an MCB with signal auxiliaries guarantees the functionality of the "Great Dispatcher" DIN rail clamp.
- . Auxiliaries are clipped on the left of the m.c.b.
- . Maximum number of auxiliaries for one circuit-breaker: 3.
- . Two signalling auxiliaries max. (cat. n° 4 062 50 /52 /56 /64).
- . Only one control auxiliary (cat. n° 4 062 76 / 78 / 80 / 82 / 84 / 86 /87).
- . One remote control or Stop & Go motor driven remote control
- . If signalling and control auxiliaries are associated on the same circuit breaker, the command auxiliary must be placed to the left of the signal auxiliary

Sealing:

- . Possible in "Open" position (OFF) or "Close" position (ON).

Locking:

- . By 5 mm padlock (cat. N° 4 063 13) or 6 mm padlock (cat. n° 0 227 97) with padlock support (cat. n° 4 063 03) in "Open" position (OFF).

Installation software:

- . XL PRO³