

### DPX 1600

4 043 80  
4 043 81  
4 043 82

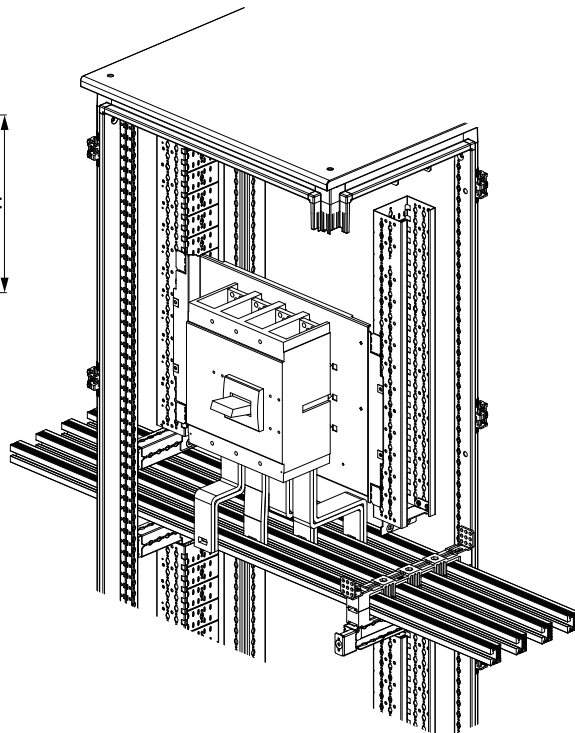
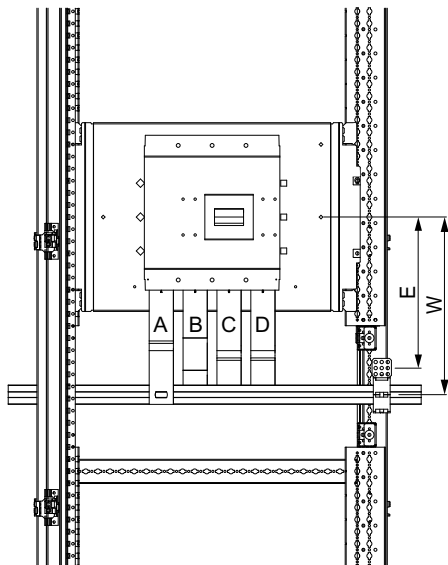
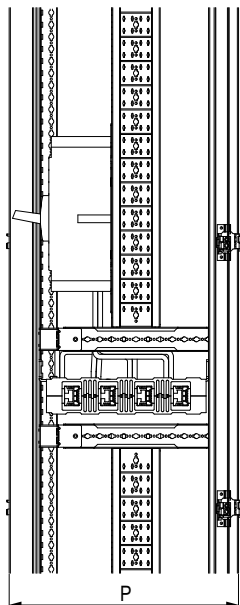

	E	P	W		M10
	mm	mm	mm		Nm
4 043 80	312	475	367	x 4	50
4 043 81	237	725	292	x 4	50
4 043 82	337	725	392	x 4	50

### DPX 1600

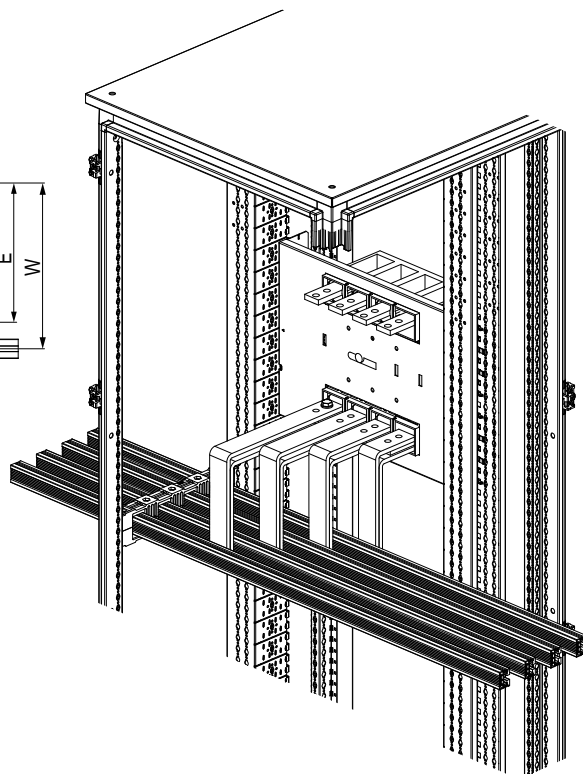
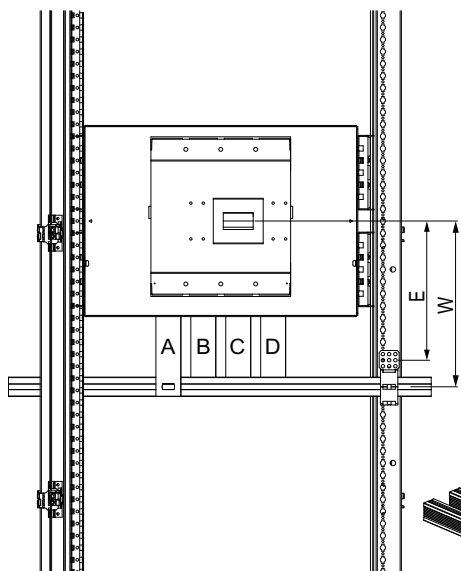
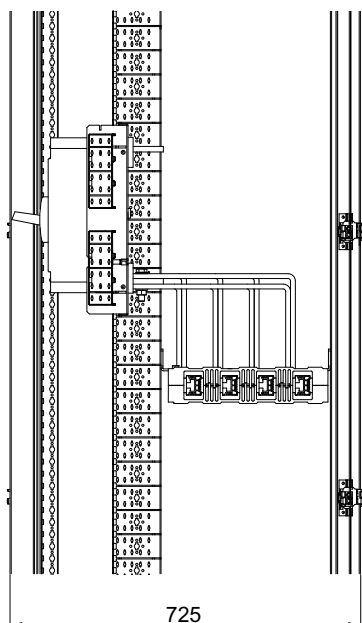

4 043 83  
4 043 84



	E	W		M10		M12
	mm	mm		Nm		Nm
4 043 83	287,5	342,5	x 4	50	x 8	70/85
4 043 84	337,5	392,5	x 4	50	x 8	70/85

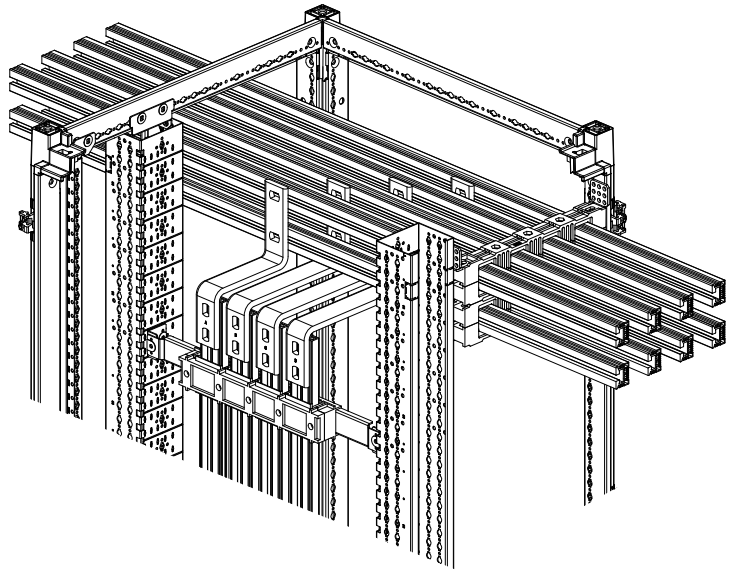
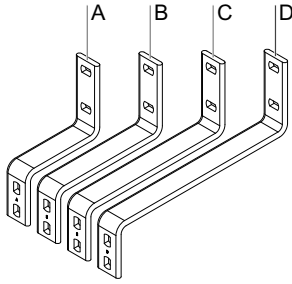
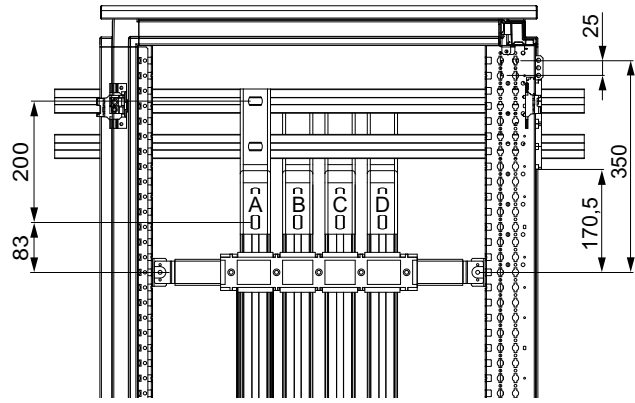
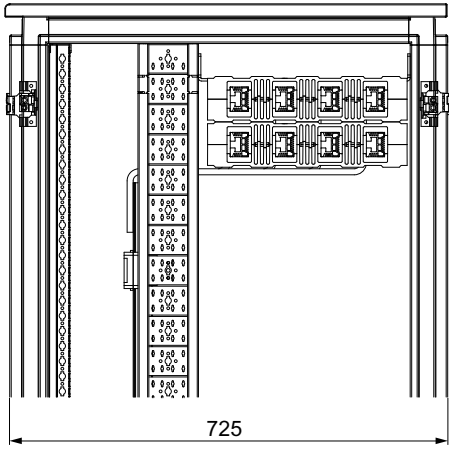



4 045 30



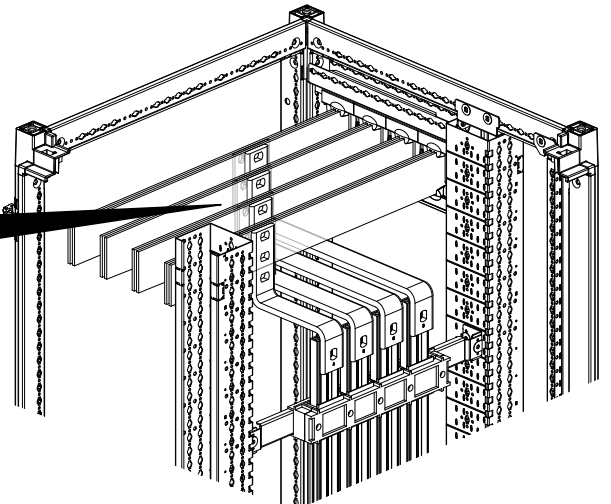
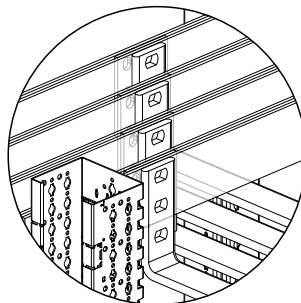
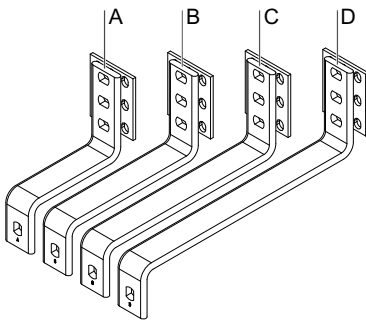
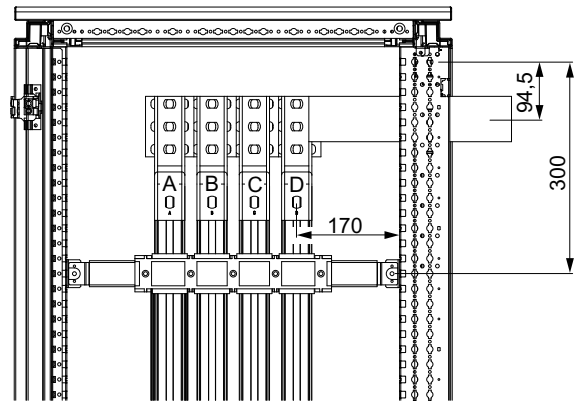
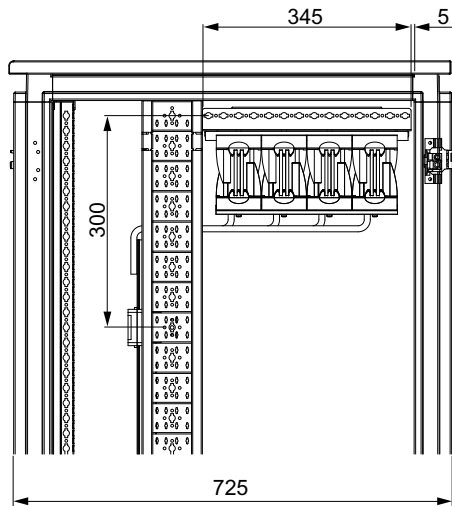

	M10	In
	8.8	
	Nm	A
	x 16	50 800

4 045 31



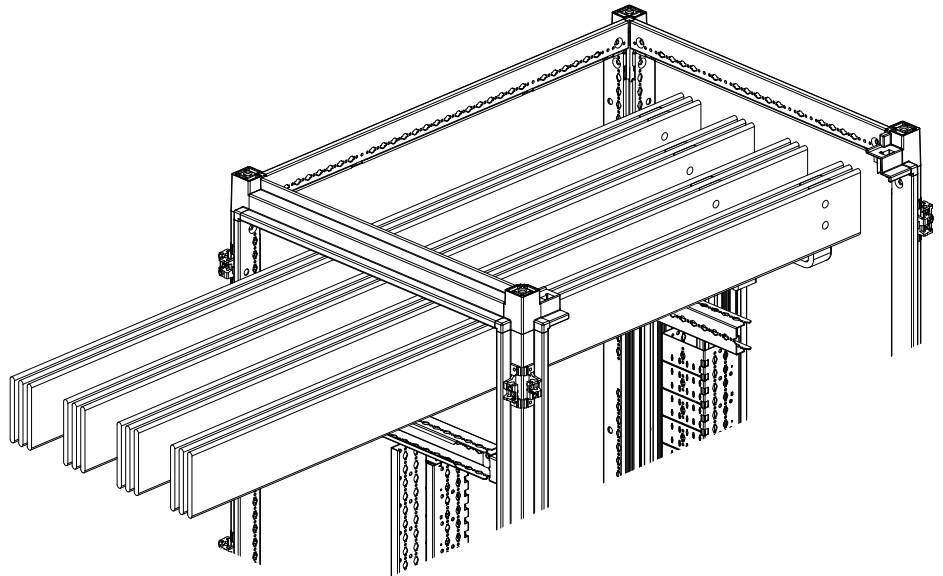
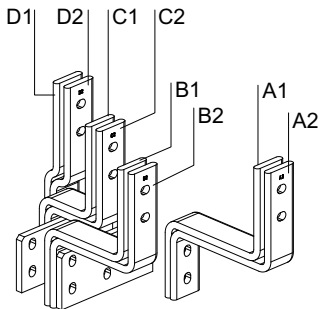
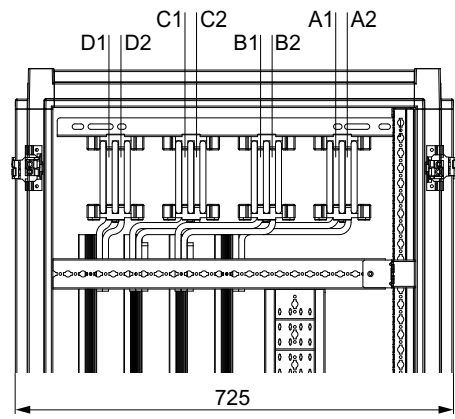
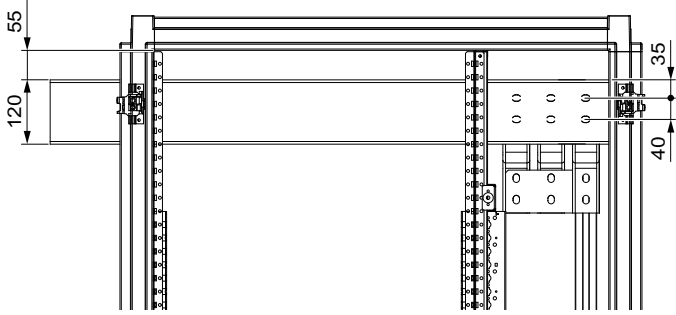

	M8		M10	In
			8.8	
	Nm		Nm	A
	x 4		20	x 8

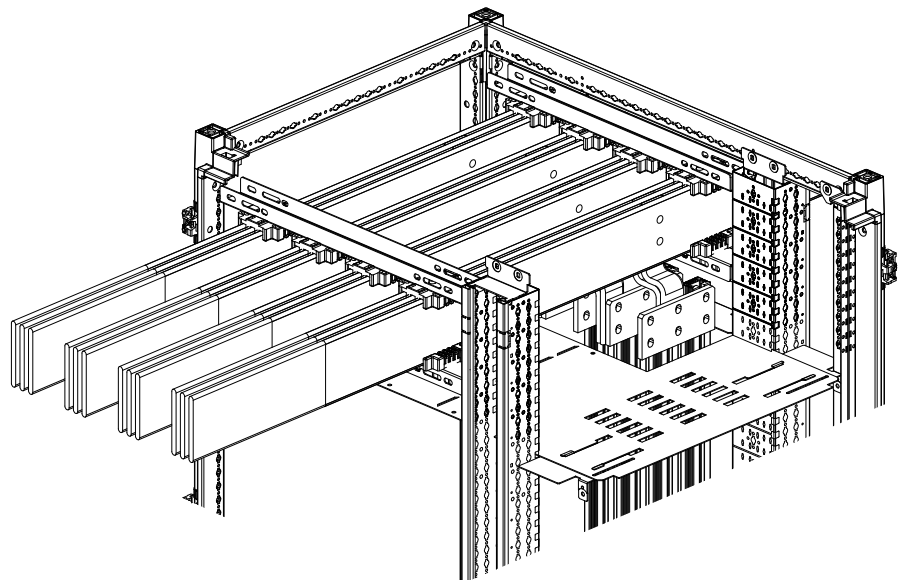
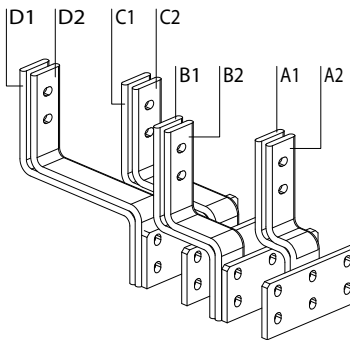
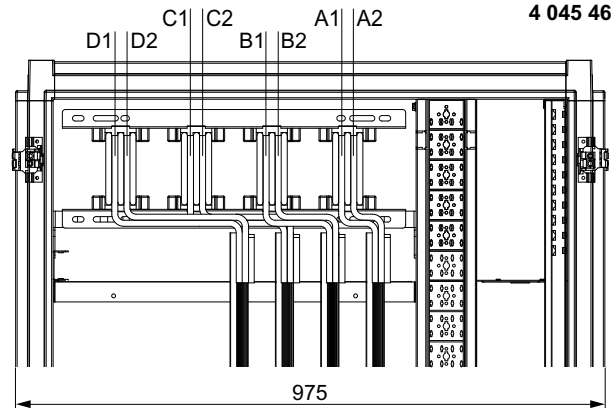
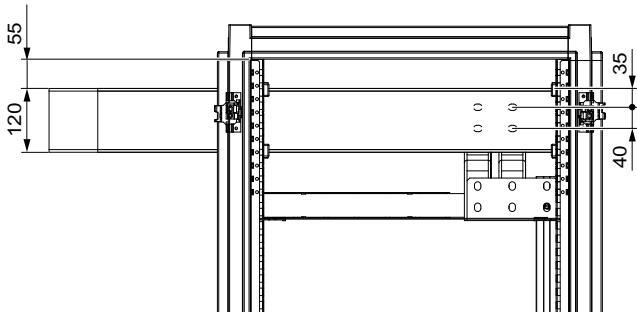

	M10 8.8		M10 8.8	In
	Nm		Nm	A
x 8	50	x 12	40/50	1600



	M10 8.8		M10 8.8	In
	Nm		Nm	A
x 8	50	x 16	40/50	1600

4 046 90

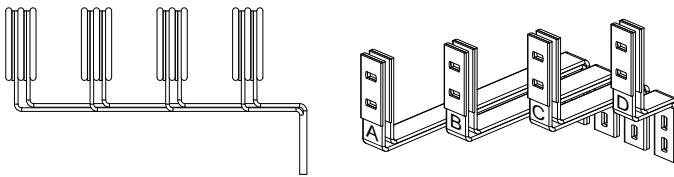
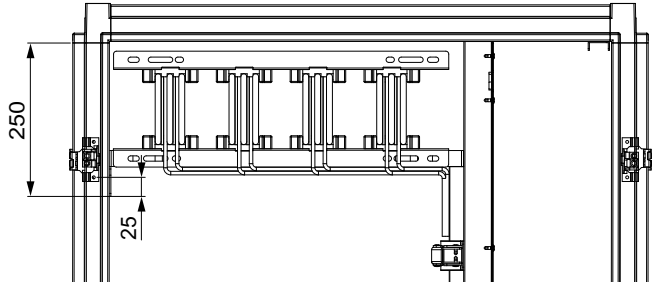
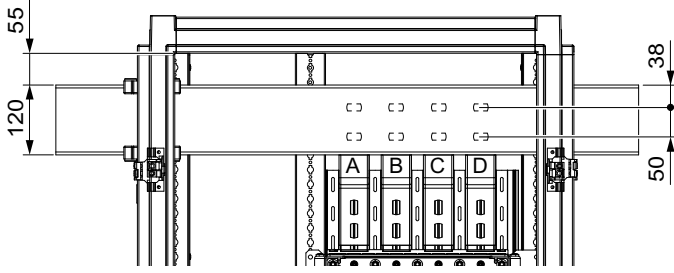

	M10		M10	In
	8.8		8.8	
	Nm		Nm	A
x 8	50	x 8	40/50	1250

4 046 91

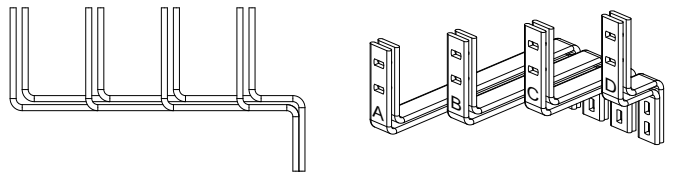
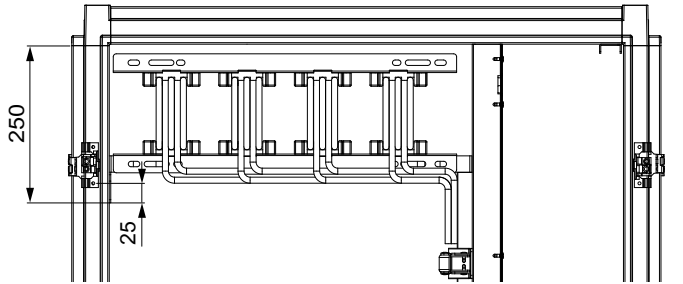
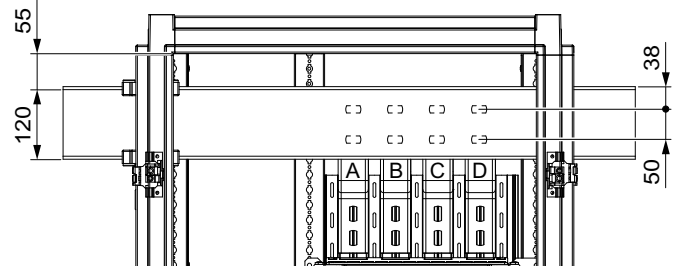

	M10		M10	In
	8.8		8.8	
	Nm		Nm	A
x 8	50	x 8	40/50	2000

4 046 92

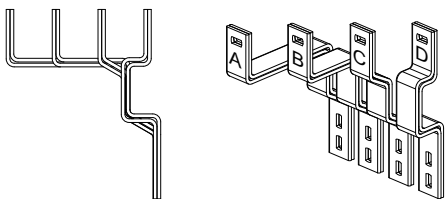
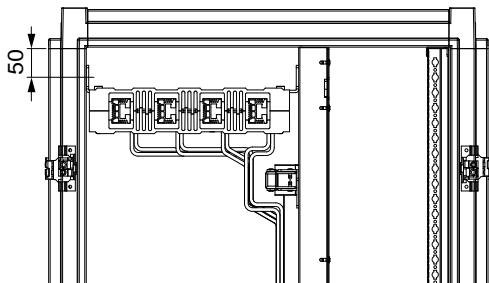
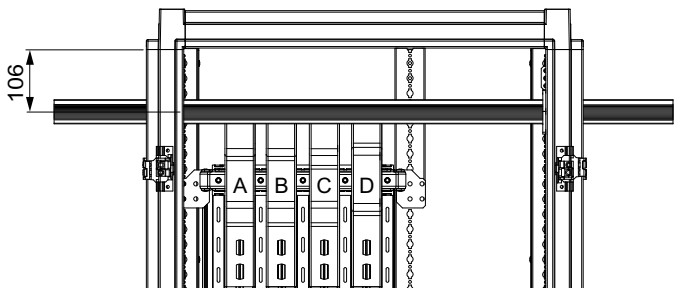

	M10	In
	8.8	
	Nm	A
x 12	50	1250

4 046 93

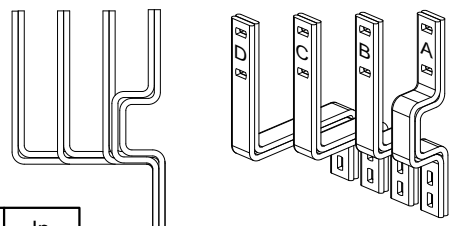
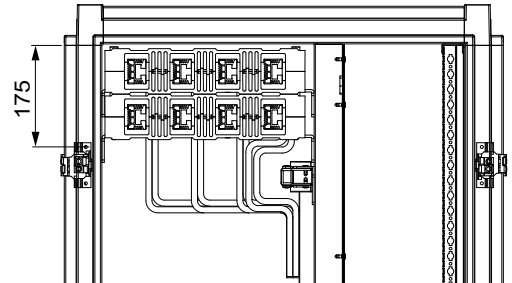
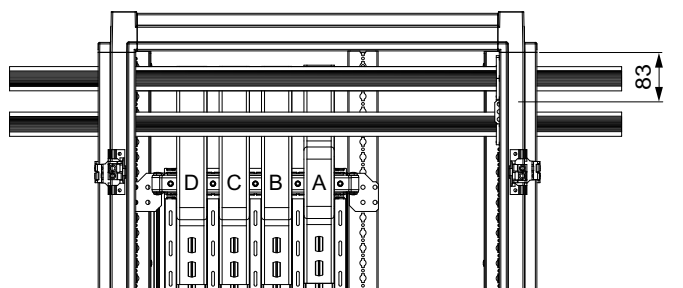

	M10	In
	8.8	
	Nm	A
x 16	50	2000