

Single-phase control and signalling transformer

Cat. Nos. : 0 442 11/12/13/14/15/16/17/18/31/32/33/34/35/
36/37/38/39/40/61/62/63/64/65/66/67/68/69/70/71/72/73/74

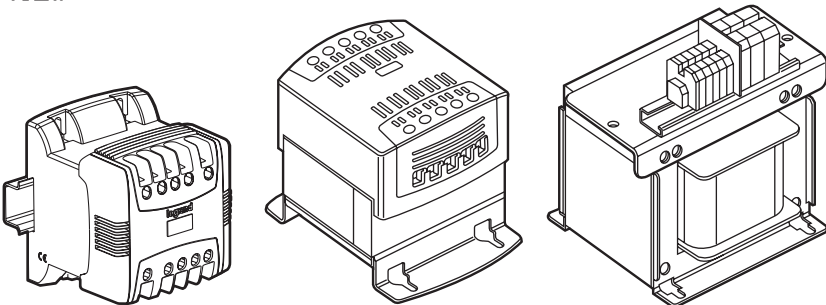

CONTENTS

- 1. Operating principle1
- 2. General characteristics1-2
- 3. Range2
- 4. Mechanical characteristics2-3
- 5. Determination of transformer power3
- 6. Electrical characteristics4-5
- 7. Others characteristics5

1. OPERATING PRINCIPLE

This transformer is intended to supply control and signalling equipment housed inside an enclosure (contactors, relays, automation systems, etc.) Certain equipment needs to be supplied with a specific voltage.

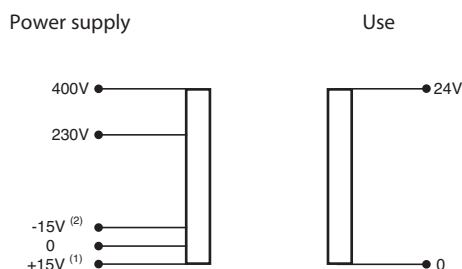

Transformers are fitted with adjustment taps of + and - 15 V on the terminal strip of the primary circuit, to adjust the secondary voltage, which is influenced by the voltage of the power supply network and/or by a device under-load

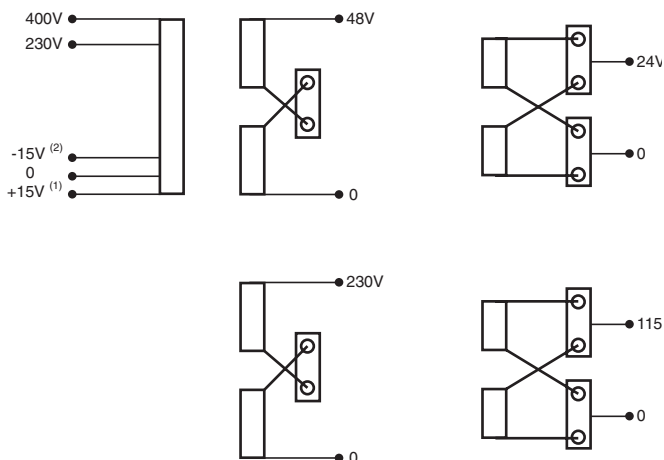

(1) Up terminal: 245 V or 415 V or load lower than the rated power
(2) Up terminal: 215 V or 385 V

2. GENERAL CHARACTERISTICS

Single-phase 50-60 Hz class I
IP2x up to 400 VA without connection strip
IP 00 with connection strip - IK 04
Insulation voltage between windings : 4510 V
Maximum ambient operating temperature : 50° C
Protected against involuntary or accidental contacts with live parts up to 1000 VA

2.1 Conformities

- Conform to IEC EN 61558-2-2 and 2-4
- Approvals UL 5085 / CSA C22 - 2 - N° 66 c
- Products suitable for the construction of equipment compliant with EN 61131-2, EN 60204-1 and EN 60439-1
- Marking C €

2.2 Transformer protection

Transformers can be protected by a gG type fuse or by a C type circuit-breaker
Supplied with a connecting strip 0 V / Ground up to 1000 VA

2.3 Casing

Covered up to 1000 VA
Bare as from 1600 VA

2.3.1 Cover

- Polyamide 6/6
- RAL 7035
- Information : Laser-engraved on the front face cover guaranteeing indelibility :
 - product Cat. No.
 - voltages
 - rated power / instantaneous power
 - protection device rating (fuses or circuit-breakers)
 - compliances
 - terminal strip marking
- Front face : flat surface 25 x 10 mm allowing marking by:
 - labels or adhesive label holders
 - inscription : manual
 -

Single-phase control and signalling transformer

Cat. Nos. : 0 442 11/12/13/14/15/16/17/18/31/32/33/34/35/36/37/38/39/40/61/62/63/64/65/66/67/68/69/70/71/72/73/74

2. GENERAL CHARACTERISTICS (continued)

2.3 Casing (continued)

2.3.2 base

40 to 400 VA, polyamide 6/6, glass-filled, flame-retardant

fixing by screws or clips up to 250 VA on rail \perp

400 VA fixing by screw only

• 630 to 1000 VA metal base with epoxy-polyester coating RAL 7000

• 1600 to 8000 VA :

Metal base with anti-corrosion coating

2.3.3 Circuit

in silicon magnetic steel sheet

- Coating : matte black paint as from 630 VA

2.3.4 Connection terminal strip

• 40 VA to 400 VA and 630 VA (115/230) :

terminal fitted with a cable clamp plate with slotted cross-head type Z screw

• from 630 VA (ELV) to 1000 VA :

cable clamp plate on the primary, cage terminal on the secondary

• 1600 to 8000 VA :

connection to Viking terminal block

3. RANGE

Primary 230/400 V ± 15 V

Secondary 24 V - 24/48 V - 115/230 V

Power according to IEC and CSA	Prim: 230 /400 ± 15 V		
	Sec : 24 V	Sec : 24/48 V	Sec : 115/230 V
40 VA	0 442 11	0 442 31	0 442 61
63 VA	0 442 12	0 442 32	0 442 62
100 VA	0 442 13	0 442 33	0 442 63
160VA	0 442 14	0 442 34	0 442 64
250 VA	0 442 15	0 442 35	0 442 65
400 VA	0 442 16	0 442 36	0 442 66
630 VA	0 442 17	0 442 37	0 442 67
1000 VA	0 442 18	0 442 38	0 442 68
1600 VA		0 442 39	0 442 69
2500 VA		0 442 40	0 442 70
4000 VA			0 442 71
5000 VA			0 442 72
6300 VA			0 442 73
8000 VA			0 442 74

Interference filtering (except 0 442 16/17/18)

4. MECHANICAL CHARACTERISTICS

4.1 Mechanical characteristics

4.1.1 Transformers 40 - 63 - 100 - 160 - 250 - 400VA

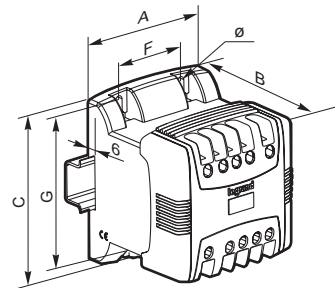

Catalogue number	Power (VA)	Dimensions (mm)			Fixing (mm)			Weight (Kg)
		A	B	C	F	G	Diameter	
0 442 11/31/61	40	94	78	113	50	100	5.2	1.23
0 442 12/32/62	63	94	85	113	50	100	5.2	1.56
0 442 13/33/63	100	94	94	113	50	100	5.2	1.95
0 442 14/34/64	160	94	112	113	50	100	5.2	2.6
0 442 15/35/65	250	106	123	115	50	100	5.2	3.82
0 442 16/36/66	400	120	140	140	62,5	125	5.2	5.82

(1) Reminder: transformers 40 - 63 - 100 - 160 - 250 VA can also be fixed on rail \perp

4.1.2 Transformers 630 - 1000 VA

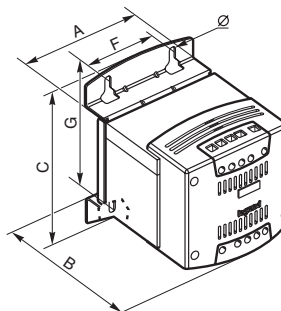

Catalogue number	Power (VA)	Dimensions (mm)			Fixing (mm)			Weight (Kg)
		A	B	C	F	G	Diameter	
0 442 17/37/67	630	132	155	175	75	150	5.5	8
0 442 18/38/68	1000	150	199	206	100	175	7	14.9

4.1.3 Transformers 1600 - 2500 VA

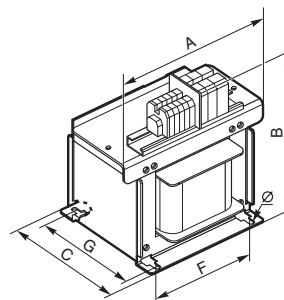

Catalogue number	Power (VA)	Dimensions (mm)			Fixing (mm)			Weight (Kg)
		A	B	C	F	G	Diameter	
0 442 39/69	1600	220	245	191	150	153	9	25.6
0 442 40/70	2500	300	292	171	200	114	9	33.1

Single-phase control and signalling transformer

Cat. Nos. : 0 442 11/12/13/14/15/16/17/18/31/32/33/34/35/36/37/38/39/40/61/62/63/64/65/66/67/68/69/70/71/72/73/74

4. MECHANICAL CHARACTERISTICS (continued)

4.1 Dimensions (continued)

4.1.3 Transformers 4000 - 5000 - 6300 - 8000 VA

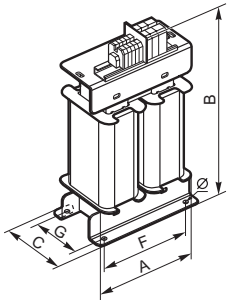

Catalogue number	Power (VA)	Dimensions (mm)			Fixing (mm)			Weight (Kg)
		A	B	C	F	G	Diameter	
0 442 71	4000	230	340	205	180	130	11	31
0 442 72	6000	240	390	205	180	130	11	40
0 442 73	6300	240	390	205	180	130	11	45
0 442 74	8000	240	390	280	180	140	11	64

Power VA	Secondary	Connection PRI Cable mm ²		Connection SEC Cable mm ²	
		Flexible	Rigid	Flexible	Rigid
40	24 V - 24/48 115/230V	1 to 4	1 to 4	1 to 4	1 to 4
63	"	1 to 4	1 to 4	1 to 4	1 to 4
100	"	1 to 4	1 to 4	1 to 4	1 to 4
160	"	1 to 4	1 to 4	1 to 4	1 to 4
250	"	1 to 4	1 to 4	1 to 4	1 to 4
400	"	1 to 4	1 to 4	1 to 4	1 to 4
630	24/48	1 to 4	1 to 4	1 to 10	1 to 10
	115/230	1 to 4	1 to 4	1 to 4	1 to 4
1000	24 V - 24/48 115/230V	1 to 16	1 to 16	1 to 16	1 to 16
1600	115/230 V	2.5 to 10	1.5 to 16	2.5 to 10	1.5 to 16
	24/48 V	2.5 to 10	1.5 to 16	4 to 16	1.5 to 25
2500	115/230 V	4 to 16	1.5 to 25	4 to 16	1.5 to 25
	24/48 V	4 to 16	1.5 to 25	4 to 16	2.5 to 50
4000	115/230 V	4 to 16	1.5 to 25	4 to 16	1.5 to 25
5000	115/230 V	4 to 16	1.5 to 25	4 to 16	1.5 to 25
6300	115/230 V	4 to 16	1.5 to 25	4 to 16	1.5 to 25
8000	115/230 V	4 to 16	1.5 to 25	4 to 16	1.5 to 25

5. DETERMINATION OF TRANSFORMER POWER

5.1. Determination of transformer power

Start with the inrush power calculated previously and use the table below

Control and safety transformer
Primary 230/400 V +/- 15 V - Secondary 24V

Catalogue number	Power (VA)	A.I.P at cos φ								
		0.2	0.3	0.4	0.5	0.6	0.7	0.8	0.9	1
0 442 11	40	62	57	53	50	48	47	46	47	58
0 442 12	63	110	100	94	88	83	80	78	78	91
0 442 13	100	230	210	180	170	150	140	140	130	150
0 442 14	160	340	300	270	250	230	220	210	210	230
0 442 15	250	550	490	450	420	400	380	370	370	430
0 442 16	400	1600	1200	1000	850	740	650	590	540	510
0 442 17	630	2200	1700	1400	1000	960	910	820	760	720
0 442 18	1000	3400	2800	2300	2000	1800	1600	1500	1400	1300

Catalogue number	Power (VA)	A.I.P at cos φ								
		0.2	0.3	0.4	0.5	0.6	0.7	0.8	0.9	1
0 442 31	40	63	58	55	52	50	48	48	49	60
0 442 32	63	110	102	94	87	83	79	77	78	91
0 442 33	100	200	180	160	150	140	130	130	130	150
0 442 34	160	340	300	270	250	230	220	210	210	230
0 442 35	250	550	490	450	420	400	380	370	370	430
0 442 36	400	1400	1100	800	700	600	500	500	400	400
0 442 37	630	2200	1700	1400	1000	960	910	820	760	720
0 442 38	1000	3400	2800	2300	2000	1800	1600	1500	1400	1300
0 442 39	1600	12800	10900	9500	8500	7700	7100	6700	6400	6600
0 442 40	2500	4300	3900	3600	3300	3100	3000	2900	2900	3400

Catalogue number	Power (VA)	A.I.P at cos φ								
		0.2	0.3	0.4	0.5	0.6	0.7	0.8	0.9	1
0 442 61	40	62	57	53	50	48	47	46	47	57
0 442 62	63	110	100	93	86	82	78	76	76	90
0 442 63	100	200	180	160	150	140	140	130	130	150
0 442 64	160	330	300	270	250	240	230	220	220	250
0 442 65	250	560	510	460	430	410	390	380	370	430
0 442 66	400	2000	1600	1300	1100	900	840	760	700	660
0 442 67	630	2300	1800	1500	1300	1100	1000	910	840	810
0 442 68	1000	3400	2800	2300	2000	1800	1600	1500	1400	1300
0 442 69	1600	8700	7500	6600	6100	5400	5000	4700	4500	4700
0 442 70	2500	9200	8300	7600	7100	6700	6300	6200	6100	7100
0 442 71	4000	16500	14300	12700	11400	10500	9800	9200	8900	9500
0 442 72	5000	28500	23400	19900	17500	15600	14200	13100	12300	12300
0 442 73	6300	17200	14500	12500	10900	10000	9200	8600	8100	8300
0 442 74	8000	19800	16600	14400	12500	11500	10600	9600	9300	9600

Single-phase control and signalling transformer

Cat. Nos. : 0 442 11/12/13/14/15/16/17/18/31/32/33/34/35/36/37/38/39/40/61/62/63/64/65/66/67/68/69/70/71/72/73/74

Catalogue number	Power (VA)	No-load loss (W)	Total loss in rated load Wiron+Wcopper (W)	Voltage drop (%) to cos φ at			Efficiency (%) to cos φ at			Ucc %
				0.3	0.6	1	0.3	0.6	1	
0 442 11	40	3.9	7.5	8.9	10.8	8.9	62	76	84	10.3
0 442 12	63	6.0	14.3	7.6	9.5	8.6	57	73	81	9.1
0 442 13	100	8.2	17.9	6.3	8.6	9.2	63	77	85	8.5
0 442 14	160	11.2	25.0	5.9	7.8	7.9	66	79	86	7.4
0 442 15	250	14.9	31.6	5.2	6.5	6.2	70	83	89	6.1
0 442 16	400	18.3	48.3	2.2	3.8	5.6	72	84	90	4.2
0 442 17	630	25.5	80.9	2.3	4	4.7	70	82	89	3.8
0 442 18	1000	44.2	73.9	1.3	2.1	2.8	80	89	93	2.3

Catalogue number	Power (VA)	No-load loss (W)	Total loss in rated load Wiron+Wcopper (W)	Voltage drop (%) to cos φ at			Efficiency (%) to cos φ at			Ucc %
				0.3	0.6	1	0.3	0.6	1	
0 442 31	40	3.9	7.3	8.7	10.5	8.5	62	77	84	10.0
0 442 32	63	6.0	14.2	7.5	9.4	8.5	57	73	82	9.0
0 442 33	100	8.2	15.1	7.3	9.3	8.9	66	80	87	8.9
0 442 34	160	11.2	24.6	5.8	7.6	7.7	66	80	87	7.2
0 442 35	250	14.9	31.4	5.2	6.6	6.2	70	83	89	6.1
0 442 36	400	18.3	46.3	2.1	3.7	5.6	72	84	90	4.2
0 442 37	630	25.5	48.5	2.3	4	4.7	70	82	89	3.8
0 442 38	1000	44.2	74.4	1.3	1.9	2.9	80	89	93	2.4
0 442 39	1600	65.5	94.7	1.1	1.6	1.9	84	91	94	1.7
0 442 40	2500	86.5	143.4	1.8	2.2	2.0	84	91	95	1.9

Catalogue number	Power (VA)	No-load loss (W)	Total loss in rated load Wiron+Wcopper (W)	Voltage drop (%) to cos φ at			Efficiency (%) to cos φ at			Ucc %
				0.3	0.6	1	0.3	0.6	1	
0 442 61	40	3.9	7.4	8.7	10.5	8.8	62	76	84	10.1
0 442 62	63	6.0	11.8	7.6	9.6	8.9	62	76	84	9.2
0 442 63	100	8.2	17.3	7.2	9.2	8.6	63	78	85	8.7
0 442 64	160	11.2	23.4	5.8	7.4	7.1	67	80	87	6.9
0 442 65	250	14.9	31.7	5.2	6.6	6.2	70	83	89	6.1
0 442 66	400	18.3	43.9	2.1	3.6	5.2	73	85	90	4.1
0 442 67	630	25.5	75.7	2.1	3.5	4.6	71	83	89	3.4
0 442 68	1000	44.2	73.6	1.3	2.0	2.7	80	89	93	2.2
0 442 69	1600	65.5	95.3	1.1	1.5	1.8	83	91	94	1.5
0 442 70	2500	86.5	150.1	1.8	2.3	2.2	83	91	94	2.0
0 442 71	4000	87.4	234.8	2.1	2.9	3.3	84	91	94	2.7
0 442 72	5000	87.4	279.0	1.5	2.3	2.9	84	91	95	2.3
0 442 73	6300	117.9	272.9	2.2	2.6	2.3	87	93	96	3.9
0 442 74	8000	195.0	336.5	1.3	1.7	1.8	88	93	96	2.9

6. ELECTRICAL CHARACTERISTICS (continued)

Duration of the admissible installed power : 50 ms

Secondary	Cat. No. :	Max. on-load dissipated power (Watts)	Admissible instantaneous power at cos φ 05	Power in VA according to UL
24V	0 442 11	7.5	50	40
	0 442 12	14.3	88	63
	0 442 13	17.9	170	100
	0 442 14	25	250	140
	0 442 15	31.6	420	210
	0 442 16	46.3	850	300
	0 442 17	80.9	1000	450
	0 442 18	73.9	2000	700
24/48V	0 442 31	7.3	52	40
	0 442 32	14.2	87	63
	0 442 33	15.1	150	100
	0 442 34	24.6	250	140
	0 442 35	31.4	420	210
	0 442 36	46.3	700	300
	0 442 37	48.5	1000	450
	0 442 38	74.4	2000	700
	0 442 39	94.7	8500	700
	0 442 40	143.4	3300	1400
115/230V	0 442 61	7.4	50	40
	0 442 62	11.8	86	63
	0 442 63	17.3	150	100
	0 442 64	23.4	250	140
	0 442 65	31.7	430	210
	0 442 66	43.9	1100	300
	0 442 67	75.7	1300	450
	0 442 68	73.6	2000	700
	0 442 69	95.3	6100	700
	0 442 70	150.1	7100	1300
	0 442 71	234.8	11400	2400
	0 442 72	279	17500	3300
	0 442 73	272	10900	3700
	0 442 74	336.5	17300	4500

LINE PROTECTION

Min. rating of protections for the power line supplying the transformer's primary circuit ⁽¹⁾

Power	230V Mono			400V Mono		
	aM type cart fuse	Circuit breaker		aM type cart fuse	Circuit breaker	
		Type C	Type D		Type C	Type D
40 VA	0.5A 013095	1A 407776		0.25A 013092	1A 407776	
63 VA	1A 013001	2A 407777		0.5A 013095	1A 407776	0.5A 408007
100 VA	1A 013001	3A 407778	1A 408008	1A 013001	2A 407777	1A 408008
160 VA	2A 013002	4A 407779	2A 408009	1A 013001	2A 407777	1A 408008
250 VA	2A 013002	6A 407780	3A 408010	2A 013002	3A 407778	2A 408009
400 VA	4A 013004	10A 407782	4A 408011	2A 013002	6A 407780	3A 408010
630 VA	6A 013006	16A 407784	6A 408012	4A 013004	8A 407781	4A 408011
1000 VA	10A 013010	20A 407785	10A 408014	4A 013004	16A 407784	6A 408012
1600 VA	10A 013010	32A 407787	16A 408015	6A 013006	20A 407785	10A 408014
2500 VA	16A 013016	50A 407789	25A 408017	10A 013010	32A 407787	16A 408015
4 kVA	25A 013025	80A 409228	32A 408018	16A 013016	40A 407788	20A 408016
5 kVA	32A 014032	80A 409228	40A 408019	16A 013016	50A 407789	25A 408017
6,3 kVA	32A 014032	100A 409229	50A 408020	20A 013020	63A 407790	32A 408018
8 kVA	40A 014040		63A 408021	25A 013025		40A 408019

⁽¹⁾ These values are given for information only for transformers with inrush currents of about 25 IN.

Single-phase control and signalling transformer

Cat. Nos. : 0 442 11/12/13/14/15/16/17/18/31/32/33/34/35/36/37/38/39/40/61/62/63/64/65/66/67/68/69/70/71/72/73/74

6. ELECTRICAL CHARACTERISTICS (continued)

- Technical characteristics of transformers at secondaries

Rating power IEC/CSA	24V		48V		115V		230V	
	Fuse	MCB Cat. No.	Fuse	MCB Cat. No.	Fuse	MCB Cat. No.	Fuse	MCB Cat. No.
40 VA	2 T2AL ⁽¹⁾		1 T1AL ⁽¹⁾		0.4 T0.4AL ⁽¹⁾		0.2 T0.2AL ⁽¹⁾	
63 VA	3.15 T3.15AL ⁽¹⁾		1.6 T1.6AL ⁽¹⁾		0.63 T0.63AL ⁽¹⁾		0.315 T0.315AL ⁽¹⁾	
100 VA	4 T4AE ⁽¹⁾	4 407695	2 T2AL ⁽¹⁾	2 407693	1 T1AL ⁽¹⁾	1 407692	0.5 T0.5AL ⁽¹⁾	0.5 407691
160 VA	8 13308	6 407697	3.15 T3.15AE ⁽¹⁾	4 407695	1.6 T1.6AL ⁽¹⁾	2 407693	0.63 T0.63AL ⁽¹⁾	1 407692
250 VA	10 13310	10 407698	6 13306	8 407696	2 T2AL ⁽¹⁾	2 407693	1 T1AL ⁽¹⁾	1 407692
400 VA	16 13316	16 407700	8 13308	8 407697	4 13304	4 407695	2 13302	2 407693
630 VA	25 13325	25 407702	12 13312	13 407699	6 13306	6 407696	4 13304	3 407694
1 KVA	40 14340	40 407704	20 13320	20 407701	8 13308	8 407697	4 13304	4 407695
1,6 KVA	63 15363	63 407790	32 14332	32 407703	16 13316	13 407699	8 13308	8 407697
2,5 KVA	100 15396	100 409229	50 14350	50 407789	20 13320	20 407701	10 13310	63 407698
4 KVA					32 14332	32 407703	16 13316	16 407700
4 KVA					40 14340	40 407704	20 13320	20 407701
6,3 KVA					50 14350	50 407789	25 13325	25 407702
8 KVA					63 15380	63 407790	32 14340	32 407703

⁽¹⁾ Fuses IEC 127 (cartridges 5 x 20 type T)

T : time delay fuse

L : low breaking capacity

7. OTHERS CHARACTERISTICS

7.1 Calorific potential (MJ)

Catalogue number			Calorific potential MJ
0 44211	0 44231	0 44261	16
0 44212	0 44232	0 44262	20
0 44213	0 44233	0 44263	25
0 44214	0 44234	0 44264	28
0 44215	0 44235	0 44265	40
0 44216	0 44236	0 44266	60
0 44217	0 44237	0 44267	55
0 44218	0 44238	0 44268	130
	0 44239	0 44269	210
	0 44240	0 44270	280
		0 44271	230
		0 44272	290
		0 44273	300
		0 44274	450

7.2 Cover and base

- Cover, polyamide 6/6 Ral 7035
- Base, polyamide 6/6 glass filled Ral 7000
- operating temperature - 30 to +100° C
- flame resistance UL94 NFT 51-072 VO
- resistance to glow wire test NFC 20-455 960° C
- tensile strength NFT 51-034 110 N/mm²
- resistance to Charpy impact test NFT 51-035 33 KJ/m²
- dielectric strength VDE 0303/2 20 KV/mm
- tracking current resistance CEI 112..... 300 V
- resistance to molds and tropical and fungi..... good.

Resistance to chemicals at a temperature of 23° C

+ : excellent resistance 0 : moderate resistance - : low resistance

Acids :

- mineral
- hydrochloric ≤10% 0
- sulphuric ≤ 10 % -
- nitric - all concentrations -
- organic
- acetic 10 % 0
- formic 10 % -

Bases :

- mineral +
- organic +
- Oils +
- Greases +
- Oil products +
- Chlorinated solvents +
- Phenols -
- Alcools +
- Hydrocarbons +
- Mineral salts +