

Reference(s) :

 422 000/ 001/ 002/ 003/ 004/ 005/ 006/ 007/ 008/ 009/ 010/ 011/ 012/ 013/ 014/  
 015/ 016/ 017/ 018/ 019/ 020/ 021/ 022/ 023/ 024/ 025/ 026/ 027/ 028/ 029/ 030/  
 031/ 032/ 033/ 034/ 035/ 036/ 037/ 038/ 039/ 040/ 041/ 042/ 043/ 044/ 045/ 046/  
 047/ 048/ 049/ 050/ 051/ 052/ 053/ 054/ 055;  
 422 216/ 217/ 218/ 219

# DPX<sup>3</sup> 630 thermal magnetic circuit breakers DPX<sup>3</sup>-I 630 switch disconnectors



## CONTENTS

## PAGES

1. USE	1
2. RANGE	1
3. DIMENSIONS AND WEIGHTS	1
4. OVERVIEW	2
5. ELECTRICAL CONNECTIONS	2
6. ELECTRICAL AND MECHANICAL CHARACTERISTICS	4
7. CONFORMITY	6
8. EQUIPMENTS AND ACCESSORIES	7
9. CURVES	10

## 1. USE

DPX<sup>3</sup> platform, for premium segment, is able to cover extended ranges in terms of breaking capacities and rated currents, make protection suitable for different levels of power involved in installations.

DPX<sup>3</sup> platform provide easy assembly procedures during the phase of installation and mounting of accessories, suitable for professional use.

## 2. RANGE

### Circuit breakers

I <sub>n</sub> (A)	DPX <sup>3</sup> 630					
	36 kA			50 kA		
	3P	4P	3P + N/2	3P	4P	3P + N/2
250	422000	422005	-	422014	422019	-
320	422001	422006	422010	422015	422020	422024
400	422002	422007	422011	422016	422021	422025
500	422003	422008	422012	422017	422022	422026
630	422004	422009	422013	422018	422023	422027
	70 kA			100 kA		
I <sub>n</sub> (A)	3P	4P	3P + N/2	3P	4P	3P + N/2
250	422028	422033	-	422042	422047	-
320	422029	422034	422038	422043	422048	422052
400	422030	422035	422039	422044	422049	422053
500	422031	422036	422040	422045	422050	422054
630	422032	422037	422041	422046	422051	422055

### Switch disconnectors

DPX <sup>3</sup> -I 630		
I <sub>n</sub> (A)	3P	4P
400	422216	422218
630	422217	422219

## 3. DIMENSIONS AND WEIGHTS

### 3.1 Dimensions

#### Implantation

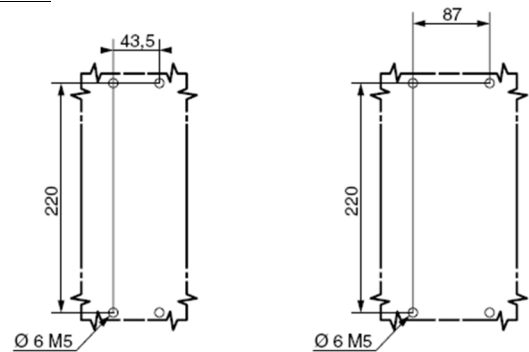

#### Fixed version, with front terminals

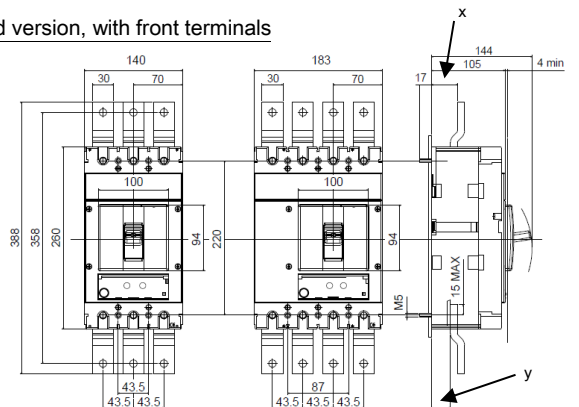

#### Fixed version, with flat rear terminal

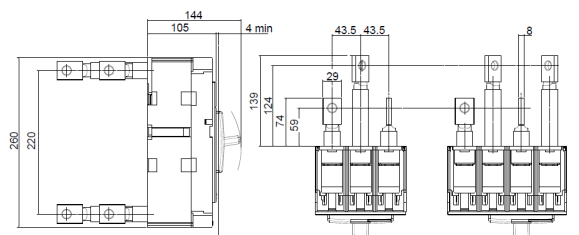

	I <sub>n</sub> < 400	I <sub>n</sub> ≥ 500 A
x	37	39
y	27	29

# DPX<sup>3</sup> 630 thermal magnetic circuit breakers DPX<sup>3</sup>-I 630 switch disconnectors

Reference(s) :

422 000/ 001/ 002/ 003/ 004/ 005/ 006/ 007/ 008/ 009/ 010/ 011/ 012/ 013/ 014/  
015/ 016/ 017/ 018/ 019/ 020/ 021/ 022/ 023/ 024/ 025/ 026/ 027/ 028/ 029/ 030/  
031/ 032/ 033/ 034/ 035/ 036/ 037/ 038/ 039/ 040/ 041/ 042/ 043/ 044/ 045/ 046/  
047/ 048/ 049/ 050/ 051/ 052/ 053/ 054/ 055;  
422 216/ 217/ 218/ 219

## Plug-in version, with cage terminals

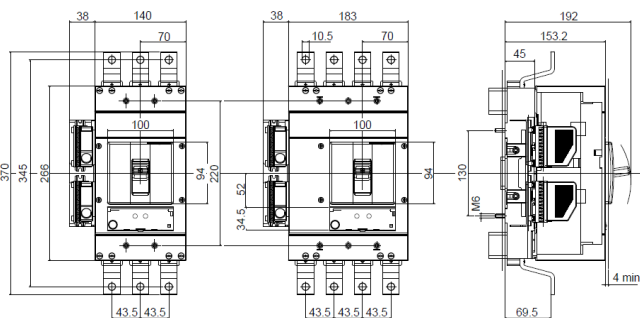

## Plug-in version, without front terminals

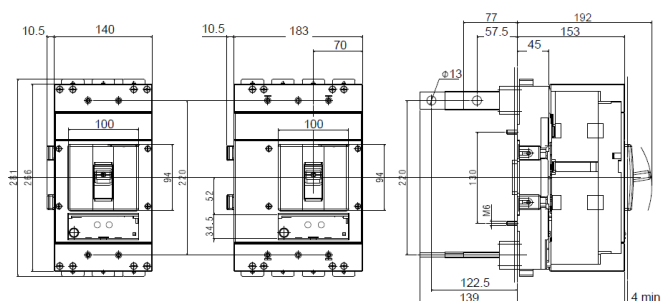

## Draw-out version, flat rear terminals

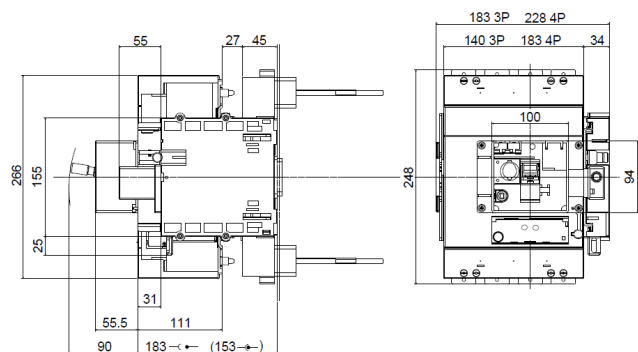

## Draw-out version with sliding auxiliary contacts

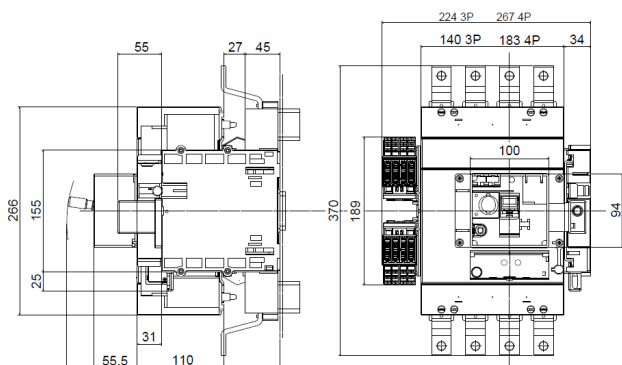

## Motor operator for synchronized operations (energy storage type)

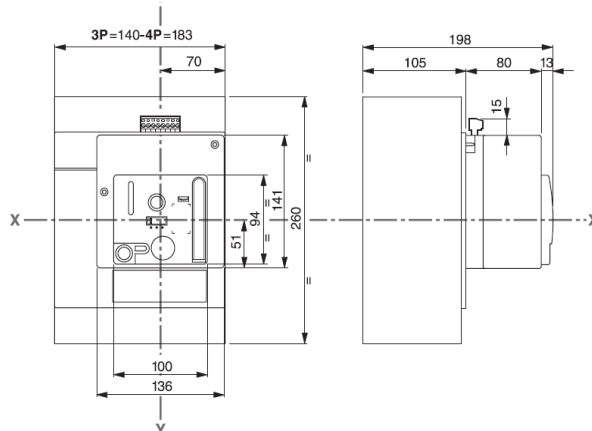

## Motor operator for general purpose operations (direct action type)

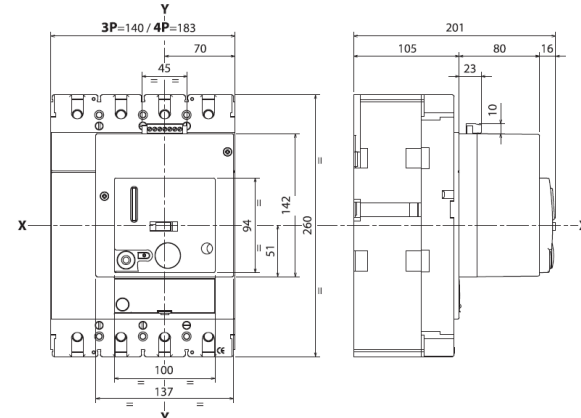

## 3.2 Weights

Configuration	Weights (Kg)			
	3P		4P	
	$I_n \leq 400A$	$I_n \geq 500A$	$I_n \leq 400A$	$I_n \geq 500A$
Circuit breaker (fixed version)	5.20	5.40	6.55	6.85
Switch disconnector (fixed version)	5.00	5.25	6.40	6.68
Plug-in (with front terminals)*	3.35	3.35	4.29	4.29
Plug-in (with rear terminals)*	3.55	3.55	4.79	4.79
Draw-out *	2.3	2.3	5.5	5.5

\* to add to fixed version

## 4. OVERVIEW

### 4.1 Supplied with:

- fixing screws (4 for 3P and 4P)
- screws for connections (6 for 3P and 8 for 4P)
- phase insulators (2 for 3P and 3 for 4P)

## 5. ELECTRICAL CONNECTIONS

### 5.1 Mounting possibilities

On plate:

- Vertical
- Horizontal
- Supply inverter type

# DPX<sup>3</sup> 630 thermal magnetic circuit breakers DPX<sup>3</sup>-I 630 switch disconnectors

Reference(s) :

422 000/ 001/ 002/ 003/ 004/ 005/ 006/ 007/ 008/ 009/ 010/ 011/ 012/ 013/ 014/  
015/ 016/ 017/ 018/ 019/ 020/ 021/ 022/ 023/ 024/ 025/ 026/ 027/ 028/ 029/ 030/  
031/ 032/ 033/ 034/ 035/ 036/ 037/ 038/ 039/ 040/ 041/ 042/ 043/ 044/ 045/ 046/  
047/ 048/ 049/ 050/ 051/ 052/ 053/ 054/ 055;  
422 216/ 217/ 218/ 219

## 5.2 Mounting

(see instruction sheet for detailed mounting procedures)

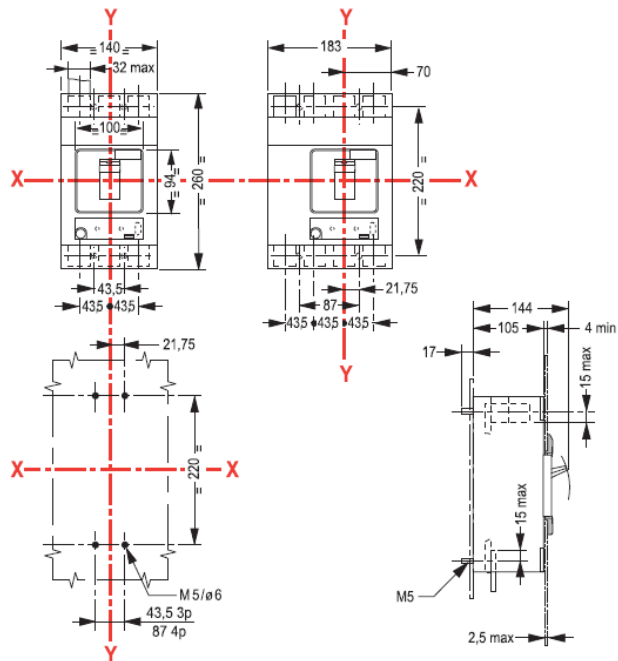

### Busbars/cable lugs:

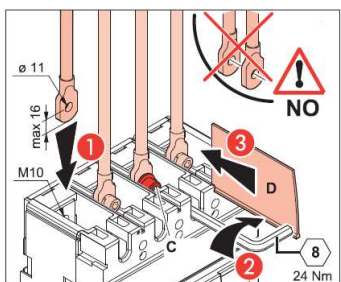
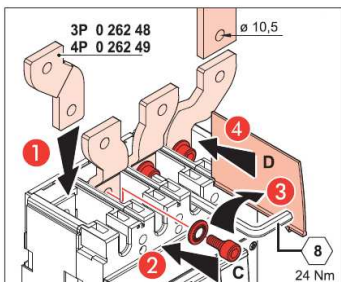
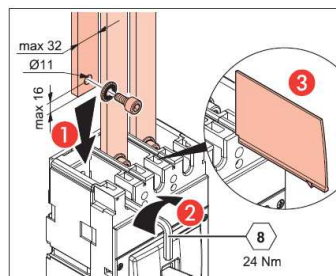

### Cables:

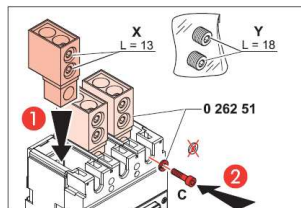
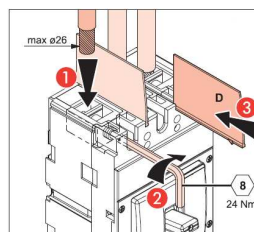
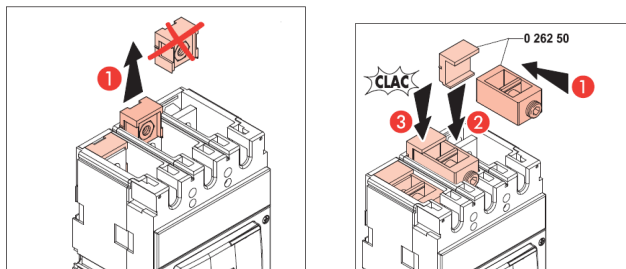

	X (L=13)	Y (L=18)
Flexible Conductors	120+185 mm <sup>2</sup>	50+95 mm <sup>2</sup>
Rigid Conductors	150+240 mm <sup>2</sup>	70+120 mm <sup>2</sup>

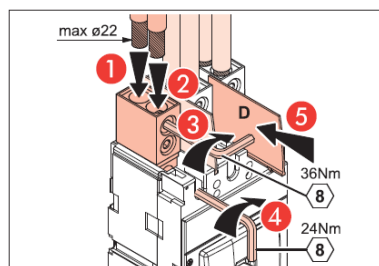

# DPX<sup>3</sup> 630 thermal magnetic circuit breakers DPX<sup>3</sup>-I 630 switch disconnectors

Reference(s) :

422 000/ 001/ 002/ 003/ 004/ 005/ 006/ 007/ 008/ 009/ 010/ 011/ 012/ 013/ 014/  
015/ 016/ 017/ 018/ 019/ 020/ 021/ 022/ 023/ 024/ 025/ 026/ 027/ 028/ 029/ 030/  
031/ 032/ 033/ 034/ 035/ 036/ 037/ 038/ 039/ 040/ 041/ 042/ 043/ 044/ 045/ 046/  
047/ 048/ 049/ 050/ 051/ 052/ 053/ 054/ 055;  
422 216/ 217/ 218/ 219

## 6. ELECTRICAL AND MECHANICAL CHARACTERISTICS

Circuit breaker

Circuit Breaker	DPX <sup>3</sup> 630 F/N/H/L (36kA, 50kA, 70kA, 100kA)
Rated current (A)	250, 320, 400, 500, 630
Poles	3 - 4
Pole pitch (mm)	42
Rated insulation voltage (50/60Hz) U <sub>i</sub> (V)	800
Rated operating voltage (50/60Hz) U <sub>o</sub> (V)	690
Rated impulse withstand current U <sub>imp</sub>	8
Rated frequency (Hz)	50 - 60
Reference ambient temperature(°C)	40 - 50
Operating temperature (°C)	-25 ÷ 70
Mechanical endurance (cycles)	20000
Mechanical endurance with motor control	10000
Electrical endurance at I <sub>n</sub> (cycles)	4000
Electrical endurance at 0.5 I <sub>n</sub> (cycles)	8000
Utilization category	A
Suitable for isolation	Yes
Type of protection	Thermal-magnetic
Thermal adjustment I <sub>r</sub>	(0.8 ÷ 1) x I <sub>n</sub>
Magnetic adjustment I <sub>i</sub> (A)	(5 ÷ 10) x I <sub>n</sub>
Neutral protection for 4P (%I <sub>th</sub> of phase pole)	100
Neutral protection for N/2 (A)	200 (I <sub>n</sub> = 320A); 250 (I <sub>n</sub> = 400A); 320 (I <sub>n</sub> = 500A); 400 (I <sub>n</sub> = 630A)
Dimensions (W x H x D) (mm)	140 x 260 x 105 (3P) 183 x 260 x 105 (4P)
Maximum weight for fixed version (kg)	5.4 (3P) 6.85 (4P)

Switch disconnectors

Switch	DPX <sup>3</sup> -I 630
Uninterrupted nominal current I <sub>n</sub> (A)	400 - 630
Short-time resistive current I <sub>sw</sub> (kA) for 1s	5 (400A) - 8 (630A)
Rated short-circuit making capacity I <sub>cm</sub> (kA)	8(400A) - 14 (630A)
Rated insulation voltage U <sub>i</sub> (V AC)	800
Maximum rated operating voltage U <sub>o</sub> (V AC)	690
Rated impulse withstand voltage U <sub>imp</sub> (kV)	8
Utilisation category	AC23A (400A) - AC22A (630A)
Suitable for isolation	Yes
Nominal frequency (Hz)	50-60
Operating temperature (°C)	-25 ÷ 70
Mechanical endurance (cycles)	20000
Mechanical endurance with motor control (cycles)	10000
Electrical endurance at I <sub>n</sub> (cycles)	4000
Electrical endurance at 0.5 I <sub>n</sub> (cycles)	8000
Dimensions (W x H x D) (mm)	140 x 260 x 105 (3P) 183 x 260 x 105 (4P)
Maximum weight for fixed version (kg)	5.25 (3P) 6.68 (4P)

## 6.1 Main parts constituting the circuit breaker

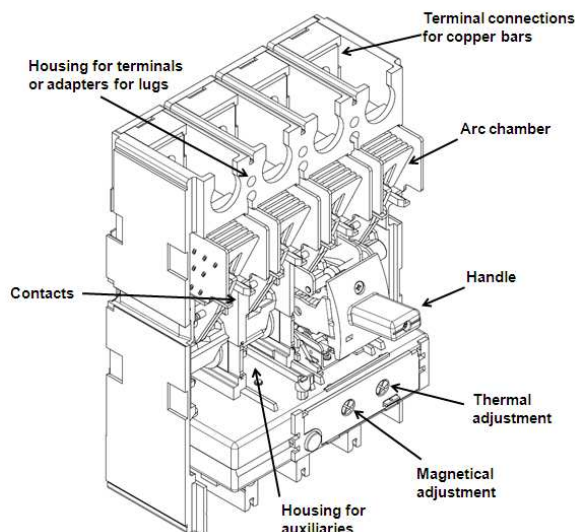

## 6.2 Breaking capacity (kA)

		Breaking capacity (kA) & I <sub>cs</sub>			
		3P-4P			
IEC 60947-2	U <sub>e</sub> /I <sub>cu</sub> (I <sub>cu</sub> letter)	36kA (F)	50kA (N)	70kA (H)	100kA (L)
	240 V AC	70	100	105	150
	415 V AC	36	50	70	100
	500 V AC	25	30	40	50
	690 V AC	14	18	20	22
	250 V DC	35	35	35	35
	I <sub>cs</sub> (% I <sub>cu</sub> )	100	100	100	70
Rated making capacity under short circuit I <sub>cm</sub>					
	I <sub>cm</sub> (kA) at 415V	76.5	105	154	220
NEMA AB-1	240 V AC	70	100	105	150
	500 V AC	25	30	40	50
	690 V AC	14	18	20	22

## 6.3 Rated current (I<sub>n</sub>) at 40°C / 50°C

I <sub>n</sub> (A)	Phases limit trip current			
	thermal (I <sub>r</sub> )		magnetic (I <sub>i</sub> )	
	0.8 x I <sub>n</sub>	1 x I <sub>n</sub>	5 x I <sub>n</sub>	10 x I <sub>n</sub>
250	200	250	1250	2500
320	256	320	1600	3200
400	320	400	2000	4000
500	400	500	2500	5000
630	504	630	3150	6300

\* For neutral adjustment, as explained in technical sheet, please consider the values ratios 100% on set currents.

## 6.3 Load operations

Force on handle	I <sub>n</sub> ≤ 400A	I <sub>n</sub> ≥ 500A
Opening operation (N)	80	130
Closing operation (N)	180	210
Restore operation (N)	145	200

## 6.4 Electrodynamic forces

The table below shows an indication of suggested distances to keep between the breaker and the first fixing point of the conductor and bars in order to reduce the effects of the electrodynamic stresses that may

# DPX<sup>3</sup> 630 thermal magnetic circuit breakers

## DPX<sup>3</sup>-I 630 switch disconnectors

Reference(s) :

422 000/ 001/ 002/ 003/ 004/ 005/ 006/ 007/ 008/ 009/ 010/ 011/ 012/ 013/ 014/  
015/ 016/ 017/ 018/ 019/ 020/ 021/ 022/ 023/ 024/ 025/ 026/ 027/ 028/ 029/ 030/  
031/ 032/ 033/ 034/ 035/ 036/ 037/ 038/ 039/ 040/ 041/ 042/ 043/ 044/ 045/ 046/  
047/ 048/ 049/ 050/ 051/ 052/ 053/ 054/ 055;  
422 216/ 217/ 218/ 219

be created during a short circuit. In the realization of anchorage system it is recommend the use of isolators suitable for the type of conductor used and the operating voltage.

I <sub>cc</sub> (kA)	Maximum Distance (mm)
36	350
50	300
70	250
100	200

According to conductor type and bar system (except Legrand bar kits), the choice of the distance to keep is to be calibrated by the installer.

Also installer must take into account the weight of the conductors so that this does not affect the electrical junction between the conductor itself and the connection point.

### 6.5 Power losses per pole under I<sub>n</sub>

Circuit breaker

	Power losses per pole (W)									
	I <sub>n</sub> (A)									
	250		320		400		500		630	
	Phase	Neutral	Phase	Neutral	Phase	Neutral	Phase	Neutral	Phase	Neutral
Cage terminals	19.2	19.2	16.4	16.5	25.6	18.9	23.6	28.7	37.3	21.2
Lugs	19.2	19.2	16.4	16.5	25.6	18.9	23.6	28.7	37.3	21.2
External lugs	19.9	19.9	17.6	16.8	27.5	19.7	26.6	30.0	42.1	23.1
Spreaders	20.6	20.6	18.8	17.1	29.3	20.4	28.2	30.6	44.7	24.1
Rear terminals	20.4	20.4	18.4	17.0	28.7	20.2	28.5	30.7	45.0	24.3
Plugin version	26.7	26.7	28.8	19.6	44.9	26.5	53.9	41.1	85.3	40.5
Circuit breaker + RCD	22.3	22.3	21.5	17.7	33.6	22.1	36.1	33.8	57.2	29.2

Note: power loss in the table above are referred and measured as described in the standard IEC 60947-2 (Annex G) for circuit-breakers.

Values in the table are referred to a single phase.

Switch disconnectors

	Power losses per pole (W)			
	I <sub>n</sub> (A)			
	400		630	
	Phase	Neutral	Phase	Neutral
Cage terminals	25.6	25.6	37.3	37.3
Lugs	25.6	25.6	37.3	37.3
External lugs	27.5	27.5	42.1	42.1
Spreaders	29.3	29.3	44.7	44.7
Rear terminals	28.7	28.7	45.0	45.0
Plugin version	44.9	44.9	85.3	85.3
Circuit breaker + RCD	33.6	33.6	57.2	57.2

Note: power loss in the table above are referred and measured as described in the standard IEC 60947-3 for switches. Values in the table are referred to a single phase.

### 6.6 DERATINGS

#### 6.6.1 Temperature

Rated current and his adjustment has to be considered relating to a rise or fall of ambient temperature and to a different version or installation conditions. The table below indicates the maximum long-time (LT) protection setting depending on the ambient temperature.

I <sub>n</sub> (A)	Temperature Ta (°C)						
	10	20	30	40	50	60	70
250	336	307	279	250	250	222	193
320	416	384	352	320	320	288	256
400	475	460	425	400	400	360	320
500	600	550	525	500	500	455	410
630	700	683	650	630	630	580	530

For derating temperature with other configurations, see table A.

#### 6.6.2 Specific condition use

Climatic conditions

according to IEC/EN 60947-1 Annex Q, Cat. F subject to temperature, humidity, vibration, shock and salt mist.

Pollution degree

for DPX<sup>3</sup> 630 circuit breakers, degree 3, according to IEC/EN 60947-2

#### 6.6.3 Altitude

Altitude derating for DPX<sup>3</sup> and DPX<sup>3</sup>-I

Altitude (m)	2000	3000	4000	5000
U <sub>e</sub> (V)	690	590	520	460
I <sub>n</sub> (A) (T <sub>a</sub> = 40°C/50°C)	1 x I <sub>n</sub>	0.98 x I <sub>n</sub>	0.93 x I <sub>n</sub>	0.9 x I <sub>n</sub>

#### 6.6.4 Use in DC

See table B.

# DPX<sup>3</sup> 630 thermal magnetic circuit breakers DPX<sup>3</sup>-I 630 switch disconnectors

Reference(s) :

422 000/ 001/ 002/ 003/ 004/ 005/ 006/ 007/ 008/ 009/ 010/ 011/ 012/ 013/ 014/  
015/ 016/ 017/ 018/ 019/ 020/ 021/ 022/ 023/ 024/ 025/ 026/ 027/ 028/ 029/ 030/  
031/ 032/ 033/ 034/ 035/ 036/ 037/ 038/ 039/ 040/ 041/ 042/ 043/ 044/ 045/ 046/  
047/ 048/ 049/ 050/ 051/ 052/ 053/ 054/ 055;  
422 216/ 217/ 218/ 219

## 7. CONFORMITY

DPX<sup>3</sup> range of product concerning circuit-breakers and switch-disconnectors exceed compliance with the IEC/EN standard 60947-2 and 60947-3 respectively. Certification available by IECEE CB-scheme or LOVAG Compliance scheme.

Marks as CCC (China), EAC (Eurasian Federation) or different local certification are available.

DMX<sup>3</sup> are in conformity with the Lloyds Shipping Register, RINA and Bureau Veritas Marine.

DMX<sup>3</sup> respect the European Directives REACH, RoHS, RAEE and Product Environment Product (PEP Ecopassport) are available.

*For specific information, please contact Legrand support.*

### 7.1 Marking

Product (both circuit breakers and switch disconnectors) are provided with labelling in full conformity to the referred standard and directives requirements by laser or sticker labels as:

#### Product laser label on front

- Manufacturer responsible
- Denomination, type product, code
- Standard conformity
- Standard characteristics declared
- coloured identification of I<sub>cu</sub> at 415V

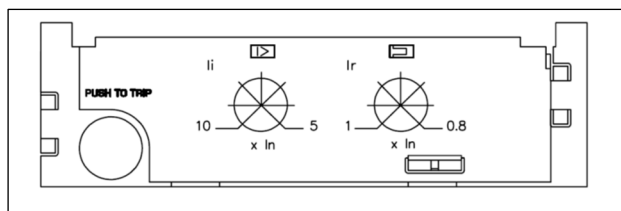

#### Product sticker label on side

- Manufacturer responsible
- Denomination and type product
- Standard conformity
- Mark/Licence (if any)
- Directive requirements
- bar code identification product
- Manufacturing Country

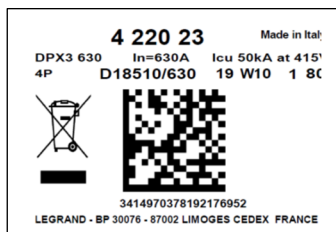

#### Mark sticker label on side

- Product code
- Mark/Licence (if any)
- Country deviation, if any

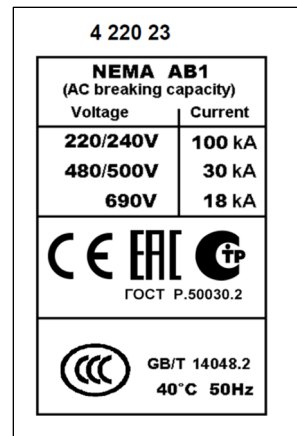

#### Packaging sticker label

- Manufacturer responsible
- Denomination and type product
- Standard conformity
- Mark/Licence (if any)
- Directive requirements
- bar code identification product





# DPX<sup>3</sup> 630 thermal magnetic circuit breakers DPX<sup>3</sup>-I 630 switch disconnectors

Reference(s) :

422 000/ 001/ 002/ 003/ 004/ 005/ 006/ 007/ 008/ 009/ 010/ 011/ 012/ 013/ 014/  
015/ 016/ 017/ 018/ 019/ 020/ 021/ 022/ 023/ 024/ 025/ 026/ 027/ 028/ 029/ 030/  
031/ 032/ 033/ 034/ 035/ 036/ 037/ 038/ 039/ 040/ 041/ 042/ 043/ 044/ 045/ 046/  
047/ 048/ 049/ 050/ 051/ 052/ 053/ 054/ 055;  
422 216/ 217/ 218/ 219

## 8. EQUIPMENTS AND ACCESSORIES

### 8.1 Earth leakage modules

Earth leakage characteristics for DPX <sup>3</sup> 630		
	Standard	with Led
Type	A - S	A - S
Uninterrupted nominal current I <sub>n</sub> (A)	up to 630	up to 630
Rated isolated voltage U <sub>i</sub> (V AC)	500	500
Rated operating voltage U <sub>e</sub> (V AC) (50-60Hz)	500	500
Operating voltage (V AC) (50-60Hz)	230 ÷ 500	110 ÷ 500
Nominal frequency (Hz)	50 - 60	50 - 60
Operating temperature (°C)	-25 ÷ 70	-25 ÷ 70
Trip	electronic	electronic
Earth leakage time adjustments (s)	0 - 0.3 - 1 - 3	0 - 0.3 - 1 - 3
Earth leakage breaking capacity I <sub>adm</sub> (% I <sub>cu</sub> )	60	60
Earth leakage protection adjustments I <sub>Δn</sub> (A)	0.03 ÷ 3	0.03 ÷ 3
Side-by-side mounting	no	no
Underneath mounting	yes	yes
50% Earth fault detection contact I <sub>Δn</sub>	no	yes
Clip on rail DIN 35	no	no
Dimensions (W x H x D) (mm) for 4P	183 x 152 x 105	183 x 152 x 106

(Power losses, see par. 5.4)

Standard

I<sub>n</sub> = 400A      3P      *ref. 0 260 60*  
                    4P      *ref. 0 260 61*  
I<sub>n</sub> = 630A      3P      *ref. 0 260 64*  
                    4P      *ref. 0 260 65*

LED version

400A      4P      *ref. 0 260 63*  
630A      4P      *ref. 0 260 67*

### 8.2 Releases (for DPX<sup>3</sup> 630 / DPX<sup>3</sup> 1600)

- shunt releases with voltage:

24 Vac and dc      *ref. 4 222 39*  
48 Vac and dc      *ref. 4 222 40*  
110÷130 Vac and dc      *ref. 4 222 41*  
220÷250 Vac and dc      *ref. 4 222 42*  
380÷440 Vac and dc      *ref. 4 222 43*

Shunt releases electrical characteristics	
Rated voltage (U <sub>c</sub> )	Both ac and dc: 24V/48V/110÷130V/220÷250V/380÷440V
Voltage range (%U <sub>c</sub> )	70 ÷ 110
Intervention time (ms)	≤ 50
Power consumption (W/VA)	300
Minimum opening time (ms)	50 ms
Insulation voltage (kV)	2,5

- undervoltage releases with voltage:

24 V dc      *ref. 4 222 44*  
24 V ac      *ref. 4 222 45*  
48 V dc      *ref. 4 222 46*  
110 - 125 V ac      *ref. 4 222 47*  
220 - 240 V ac      *ref. 4 222 48*  
380 - 415 V ac      *ref. 4 222 49*

Undervoltage releases electrical characteristics	
Rated voltage (U <sub>c</sub> )	ac: 24V/110÷125V/220÷240V/380÷415V dc: 24V/48V
Voltage range (%U <sub>c</sub> )	85 ÷ 110
Minimum opening time (ms)	50
Power consumption (W/VA)	1.6 / 5

- time-lag undervoltage releases (800 ms)

*Time-lag modules with voltage:*

230 V ac      *ref. 0 261 90*  
400 V ac      *ref. 0 261 91*

Universal Release      *ref. 4 226 23*  
(to be equipped with a time-lag module 0 261 90/91)

### 8.3 Auxiliary contacts (for DPX<sup>3</sup> 630 / DPX<sup>3</sup> 1600)

Changeover switch 3A – 250 VAC      *ref. 4 210 11*

To show the state of the contacts or opening of the DPX<sup>3</sup>/DPX<sup>3</sup>-I on a fault:

- Auxiliary contact (standard)      **OC**
- Fault signal      **CTR**

Auxiliary contact electrical characteristics		
Rated voltage (V <sub>n</sub> )	V (ac or dc)	24 to 250
Intensity (A)	24 V dc	5
	48 V dc	1.7
	110 V dc	0.5
	230 V dc	0.25
	110 V ac	4
	230/250 V ac	3

Configurations:

DPX<sup>3</sup> 630 → 2 auxiliary contacts + 1 fault signal + 1 release

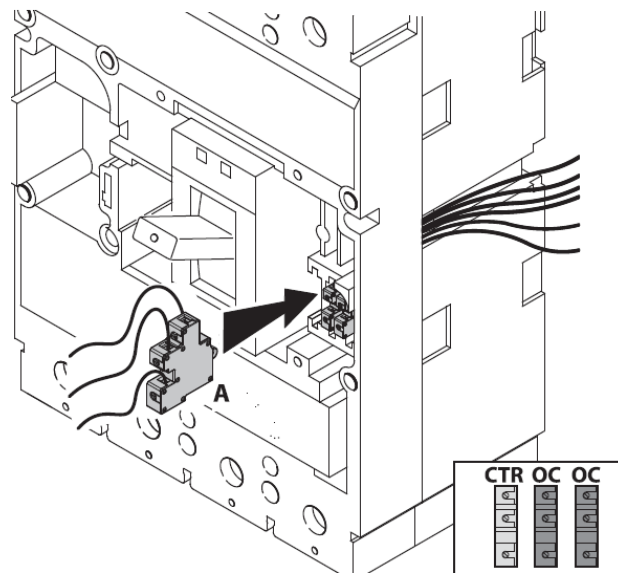

To get more information on auxiliary mounting procedures, please refer to product instruction sheet.

# DPX<sup>3</sup> 630 thermal magnetic circuit breakers

## DPX<sup>3</sup>-I 630 switch disconnectors

Reference(s) :

422 000/ 001/ 002/ 003/ 004/ 005/ 006/ 007/ 008/ 009/ 010/ 011/ 012/ 013/ 014/  
015/ 016/ 017/ 018/ 019/ 020/ 021/ 022/ 023/ 024/ 025/ 026/ 027/ 028/ 029/ 030/  
031/ 032/ 033/ 034/ 035/ 036/ 037/ 038/ 039/ 040/ 041/ 042/ 043/ 044/ 045/ 046/  
047/ 048/ 049/ 050/ 051/ 052/ 053/ 054/ 055;  
422 216/ 217/ 218/ 219

### 8.4 Rotary handles

*Direct on DPX<sup>3</sup> (with auxiliary option)*

- Standard (black) *ref. 0 262 41*
- For emergency use (red / yellow) adapting on standard handle *ref. 4 222 38*

*Vari-depth handle IP55 (with auxiliary option)*

- Standard (black) *ref. 0 262 81*
- For emergency use (red / yellow) adapting on standard handle *ref. 0 262 82*

*Locking accessories (for vary-depth handle with auxiliary option)*

- Key barrel and flat key (cod. ABA90GEL6149) *ref. 0 262 93*
- Key barrel and star key (cod. HBA90GPS6149) *ref. 0 262 94*
- Key barrel and flat key fixed (cod. EL43525) *ref. 4 228 04*
- Key barrel and flat key fixed (cod. EL43363) *ref. 4 228 05*

*Locking accessories (for direct handle)*

- Key barrel and flat key *ref. 0 262 25*

*Direct on DPX<sup>3</sup> (no auxiliary option and door defeat function)*

- Standard (black) *ref. 4 201 62*
- For emergency use (red / yellow) adapting on standard handle *ref. 4 201 65*

*Vari-depth handle IP55 (no auxiliary option and door defeat function)*

- Standard (black) *ref. 4 201 63*
- For emergency use (red / yellow) adapting on standard handle *ref. 4 201 76*

### 8.5 Motor operators (front operated)

*For general purpose operations (direct action type):*

- 230 V ac *ref. 4 226 30*

*For synchronized operations (energy storage type):*

- 24 V ac and dc *ref. 0 261 40*
- 48 V ac and dc *ref. 0 261 41*
- 110 V ac *ref. 0 261 42*
- 110 V dc *ref. 4 226 26*
- 230 V ac *ref. 0 261 44*
- 230 V dc *ref. 0 261 48*

	LG-4 226 30	LG-0 261 40-41-44	
Type	Direct drive	Energy storage	
Rated operating voltage (U <sub>J</sub> ) - AC	230V AC 50-60 Hz	24 - 48 - 230	
Rated operating voltage (U <sub>J</sub> ) - DC	230V AC 50-60 Hz	24 - 48 - 230	
Voltage range (%U <sub>c</sub> )	85±110	85±110	
	Opening	Closing	Closing
Pick-up consumption (W / VA)	240	200	300
Hold consumption (W / A)	80	120	300
Operating time / complete electric operation (ms)	450	550	2000
Operating time / main contacts change position (ms)	270	550	n/a
Mechanical endurance (O-C cycles) @I <sub>n</sub> = 630A	10000	n/a	
Electrical endurance (O-C cycles) @I <sub>n</sub> = 630A	4000	4000	
Cycles / minutes	up to 8 automatic open/close operations in a row	10	4

*Locking accessories:*

- Lock and star key (cod. HBA90GPS6149) *ref. 0 261 58*
- Lock and flat key (cod. ABA90GEL6149) *ref. 0 261 59*

### 8.6 Mechanical accessories

- Padlock (for locking in "OPEN" position) *ref. 0 262 40*
- Insulated shields (phase insulators) *ref. 0 262 30*
- Sealable terminal shields:
  - Set of 2 (for 3P) *ref. 0 262 44*
  - Set of 3 (for 4P) *ref. 0 262 45*
- Terminal covers to guarantee IP20:
  - Set of 2 (for 3P) *ref. 0 262 34*
  - Set of 3 (for 4P) *ref. 0 262 35*

### 8.7 Connection accessories

*Cage terminals*

- Set of 4 terminals for cables 300 mm<sup>2</sup> max (rigid) or 240 mm<sup>2</sup> max (flexible) Cu/Al *ref. 0 262 50*

- Set of 4 high-capacity terminals for cables 2x240 mm<sup>2</sup> max (rigid) or 2x185 mm<sup>2</sup> max (flexible) Cu/Al *ref. 0 262 51*

*Extended front terminals*

- Set of 4 *ref. 0 262 47*

*Spreaders (incoming or outgoing):*

- Set of 2 (for 3P) *ref. 0 262 48*
- Set of 3 (for 4P) *ref. 0 262 49*

*Rear terminals (incoming or outgoing):*

(used to convert the fixed version with front terminals into the fixed version with rear terminals)

- for 3P *ref. 0 263 52*
- for 4P *ref. 0 263 53*

*Adaptor for lug*

(for connecting bare cables with lugs)

- Set of 4 adaptors + insulated shields *ref. 0 262 46*



# DPX<sup>3</sup> 630 thermal magnetic circuit breakers

## DPX<sup>3</sup>-I 630 switch disconnectors

Reference(s) :

422 000/ 001/ 002/ 003/ 004/ 005/ 006/ 007/ 008/ 009/ 010/ 011/ 012/ 013/ 014/  
015/ 016/ 017/ 018/ 019/ 020/ 021/ 022/ 023/ 024/ 025/ 026/ 027/ 028/ 029/ 030/  
031/ 032/ 033/ 034/ 035/ 036/ 037/ 038/ 039/ 040/ 041/ 042/ 043/ 044/ 045/ 046/  
047/ 048/ 049/ 050/ 051/ 052/ 053/ 054/ 055;  
422 216/ 217/ 218/ 219

### 8.8 Plug-in version

(A plug-in is a DPX<sup>3</sup> fitted with special terminals and mounted on a plug-in base)

#### **Special terminals for plug-in / draw-out base** (for incoming and outgoing terminals)

- Set of 6 terminals (3P) *ref. 4 222 20*
- Set of 8 terminals (4P) *ref. 4 222 21*

#### **Bases**

(accept DPX<sup>3</sup>/DPX<sup>3</sup>-I fitted with special terminals)

- Front terminal mounting base for 3P *ref. 4 222 22*
- Front terminal mounting base for 4P *ref. 4 222 23*
- Flat rear terminal mounting base for 3P *ref. 4 222 24*
- Flat rear terminal mounting base for 4P *ref. 4 222 25*

#### **Bases for breakers with mounted earth leakage module**

- Front terminal mounting base for 4P *ref. 4 222 26*
- Flat rear terminal mounting base for 4P *ref. 4 222 27*

#### **Accessories**

- Set of 2 extractor handle *ref. 4 222 28*
- Set of connectors (24-pin) *ref. 4 222 29*

### 8.9 Draw-out version

(A DPX<sup>3</sup> draw-out version is a plug-in DPX<sup>3</sup> fitted with a "Debro-lift" mechanism which can be used to withdraw the DPX<sup>3</sup> while keeping it on its base)

#### **"Debro-lift" mechanism**

(supplied with a rigid slide and handle for drawing-out)

- For base only (3P) *ref. 4 222 31*
- For base only (4P) *ref. 4 222 32*
- For base with earth leakage module (4P) *ref. 4 222 33*

#### **Keylock for "Debro-lift" mechanism**

(enable locking in draw - out position)

Flat key n°HBA90GPS6149

Star key n°ABA90GEL6149

- One key for breaker only (flat key) *ref. 0 265 76*
- One key for breaker only (star key) *ref. 0 263 48*
- One key for motorized breaker or with rotary handle (flat key) *ref. 0 265 78*
- One key for motorized breaker or with rotary handle (star key) *ref. 0 265 77*

#### **Accessories for "Debro-lift" mechanism**

- Signalling contact (plugged-in / draw-out) *ref. 0 265 74*
- Handle for drawing - out *ref. 0 265 75*

#### **Auxiliary contacts**

- Automatic auxiliary contacts for draw-out version *ref. 4 222 30*  
(up to 2 contacts by DPX<sup>3</sup>)

#### **Plate for transfer switches (factory assembled)**

(A transfer switch plate is composed of one plate with interlock for 2 devices)

- Plate for breaker or trip-free switch fixed version *ref. 0 264 09*
- Plate for breaker or trip-free switch plug-in and draw-out version *ref. 0 264 04*

# DPX<sup>3</sup> 630 thermal magnetic circuit breakers DPX<sup>3</sup>-I 630 switch disconnectors

Reference(s) :

422 000/ 001/ 002/ 003/ 004/ 005/ 006/ 007/ 008/ 009/ 010/ 011/ 012/ 013/ 014/  
015/ 016/ 017/ 018/ 019/ 020/ 021/ 022/ 023/ 024/ 025/ 026/ 027/ 028/ 029/ 030/  
031/ 032/ 033/ 034/ 035/ 036/ 037/ 038/ 039/ 040/ 041/ 042/ 043/ 044/ 045/ 046/  
047/ 048/ 049/ 050/ 051/ 052/ 053/ 054/ 055;  
422 216/ 217/ 218/ 219

## 9. CURVES

### 9.1 Thermal magnetic tripping curve

Update: 02/07/2018

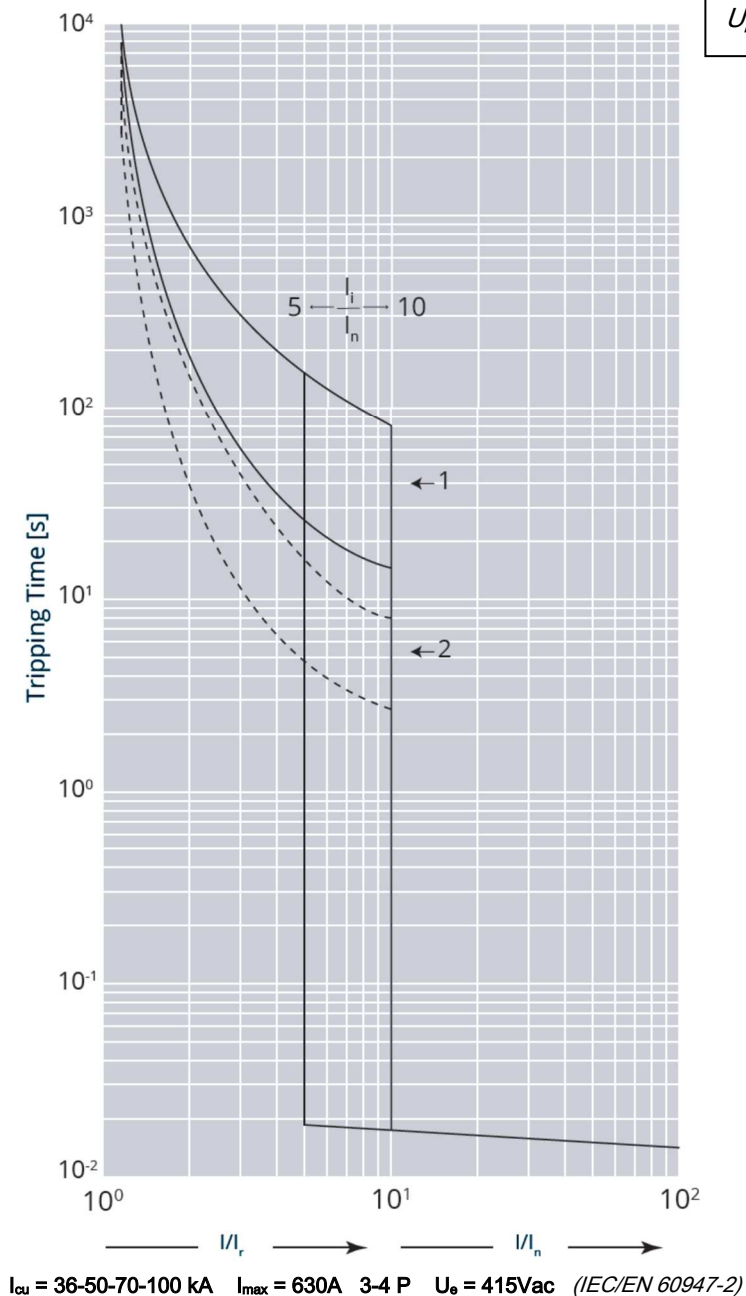

Value	Description
t	time
I	current
$I_n$	rated current
$I_r$	long time setting current
curve 1	characteristic with cold start
curve 2	characteristic with hot start

# DPX<sup>3</sup> 630 thermal magnetic circuit breakers DPX<sup>3</sup>-I 630 switch disconnectors

Reference(s) :

422 000/ 001/ 002/ 003/ 004/ 005/ 006/ 007/ 008/ 009/ 010/ 011/ 012/ 013/ 014/  
015/ 016/ 017/ 018/ 019/ 020/ 021/ 022/ 023/ 024/ 025/ 026/ 027/ 028/ 029/ 030/  
031/ 032/ 033/ 034/ 035/ 036/ 037/ 038/ 039/ 040/ 041/ 042/ 043/ 044/ 045/ 046/  
047/ 048/ 049/ 050/ 051/ 052/ 053/ 054/ 055;  
422 216/ 217/ 218/ 219

## 9.2 Pass-through specific energy characteristic curve

Update: 03/07/2018

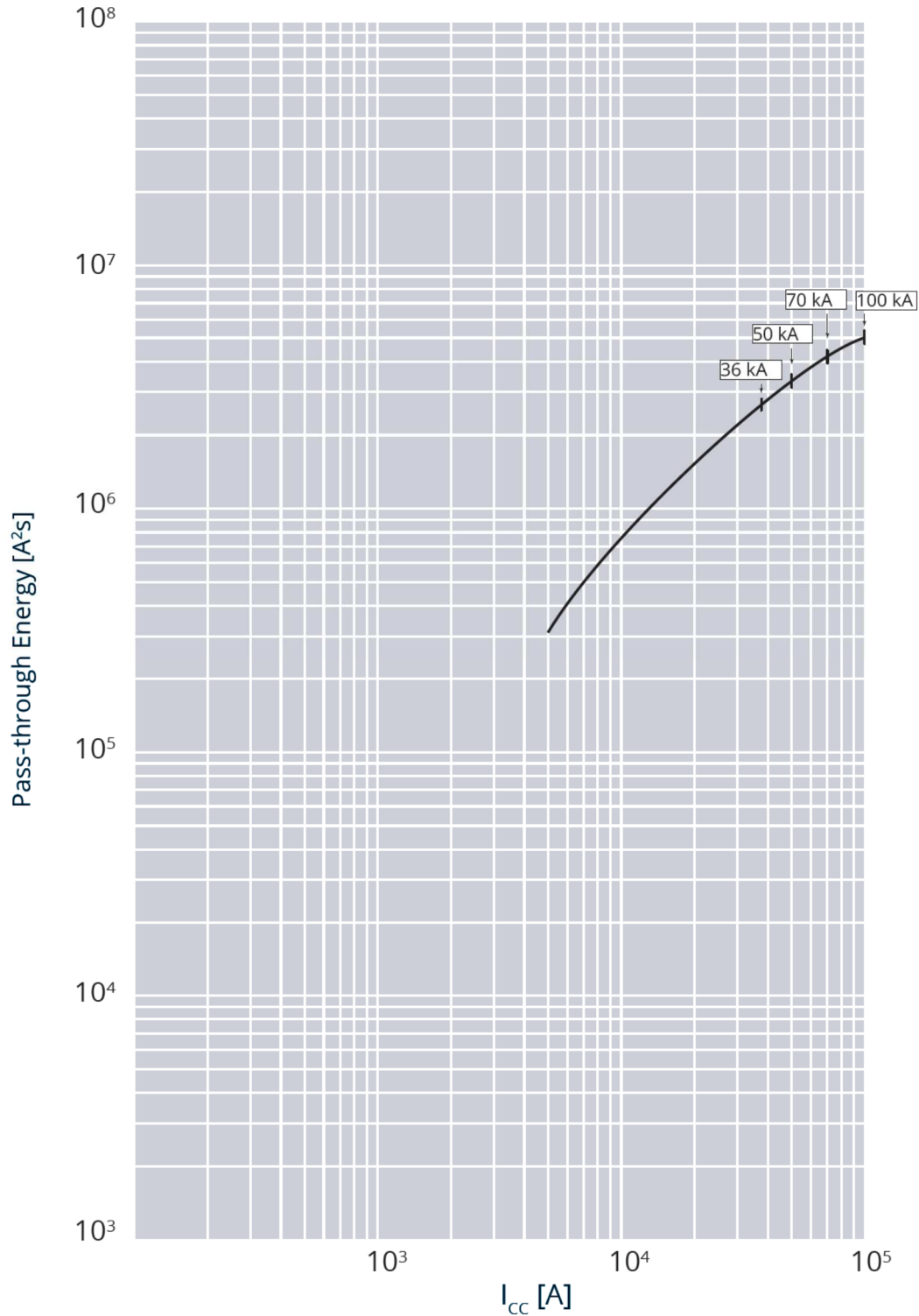

$I_{cu} = 36-50-70-100 \text{ kA}$   $I_{max} = 630A$  3-4 P  $U_o = 415Vac$  (IEC/EN 60947-2)

Value	Description
$I_{cc}$	short circuit current
$I^2t$ ( $A^2s$ )	pass-through specific energy

# DPX<sup>3</sup> 630 thermal magnetic circuit breakers DPX<sup>3</sup>-I 630 switch disconnectors

Reference(s) :

422 000/ 001/ 002/ 003/ 004/ 005/ 006/ 007/ 008/ 009/ 010/ 011/ 012/ 013/ 014/  
015/ 016/ 017/ 018/ 019/ 020/ 021/ 022/ 023/ 024/ 025/ 026/ 027/ 028/ 029/ 030/  
031/ 032/ 033/ 034/ 035/ 036/ 037/ 038/ 039/ 040/ 041/ 042/ 043/ 044/ 045/ 046/  
047/ 048/ 049/ 050/ 051/ 052/ 053/ 054/ 055;  
422 216/ 217/ 218/ 219

## 9.3 Cut-off peak current characteristic curve (kA)

Update: 02/07/2018

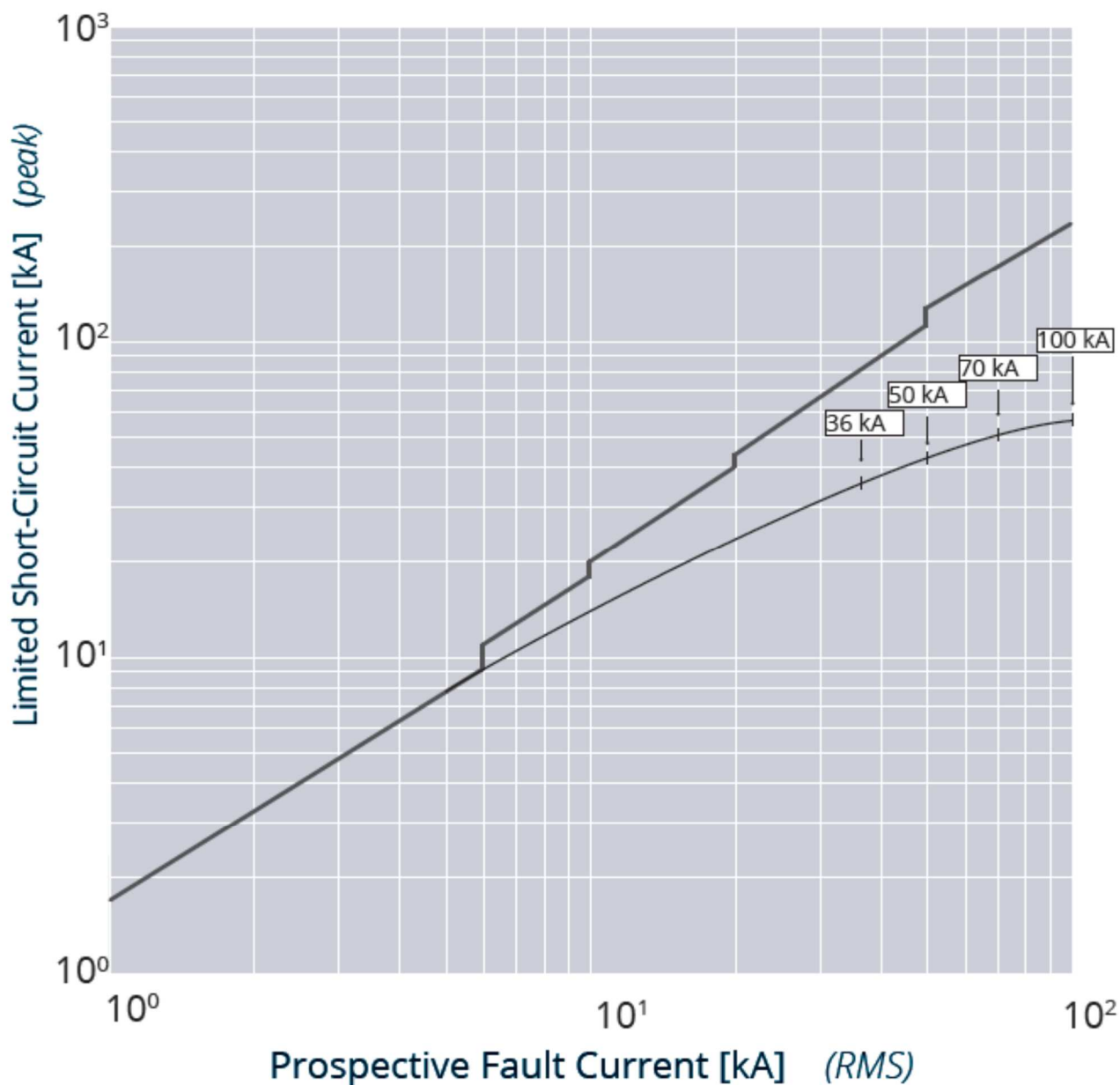

$I_{cu} = 36-50-70-100 \text{ kA}$   $I_{max} = 630\text{A}$  3-4 P  $U_o = 415\text{Vac}$  (IEC/EN 60947-2)

Value	Description
$I_{cc}$	estimated short circuit symmetrical current (RMS value)
$I_p$	maximum short circuit peak current
	maximum prospective short circuit peak current corresponding at the power factor
	maximum real peak short circuit current

# DPX<sup>3</sup> 630 thermal magnetic circuit breakers DPX<sup>3</sup>-I 630 switch disconnectors

Reference(s) :

422 000/ 001/ 002/ 003/ 004/ 005/ 006/ 007/ 008/ 009/ 010/ 011/ 012/ 013/ 014/  
015/ 016/ 017/ 018/ 019/ 020/ 021/ 022/ 023/ 024/ 025/ 026/ 027/ 028/ 029/ 030/  
031/ 032/ 033/ 034/ 035/ 036/ 037/ 038/ 039/ 040/ 041/ 042/ 043/ 044/ 045/ 046/  
047/ 048/ 049/ 050/ 051/ 052/ 053/ 054/ 055;

## A) Derating Temperature and configurations

		Ambient temperature												
		30 °C		40 °C		50 °C		60 °C		65 °C		70 °C		
Fixed version		$I_{max}$ (A)	$I_r / I_n$	$I_{max}$ (A)	$I_r / I_n$	$I_{max}$ (A)	$I_r / I_n$	$I_{max}$ (A)	$I_r / I_n$	$I_{max}$ (A)	$I_r / I_n$	$I_{max}$ (A)	$I_r / I_n$	
DPX <sup>3</sup> 630 fixed	Cage terminals, flexible cable	630	1	630	1	630	1	599	0.95	567	0.9	536	0.85	
	Lugs, flexible cable	630	1	630	1	630	1	599	0.95	567	0.9	536	0.85	
	Lugs, rigid cable	630	1	630	1	630	1	599	0.95	567	0.9	536	0.85	
	Spreaders, flexible cable	630	1	630	1	630	1	599	0.95	504	0.8	473	0.75	
	Spreaders, Cu bars	630	1	630	1	630	1	567	0.9	536	0.85	504	0.8	
	Rear flat staggered terminals, flexible cable	630	1	630	1	630	1	599	0.95	504	0.8	473	0.75	
DPX <sup>3</sup> 630 fixed + RCD	Rear flat staggered terminals, Cu bars, vertical	630	1	630	1	630	1	567	0.9	536	0.85	504	0.8	
	Cage terminals, flexible cable + RCD	599	0.95	567	0.9	567	0.9	504	0.8	473	0.75	441	0.7	
	Lugs, flexible cable + RCD	599	0.95	567	0.9	567	0.9	504	0.8	473	0.75	441	0.7	
	Lugs, rigid cable + RCD	599	0.95	567	0.9	567	0.9	504	0.8	473	0.75	441	0.7	
	Spreaders, flexible cable + RCD	536	0.85	536	0.85	536	0.85	473	0.75	410	0.65	378	0.6	
	Spreaders, Cu bars + RCD	567	0.9	536	0.85	536	0.85	504	0.8	441	0.7	378	0.6	
	Rear flat staggered terminals, flexible cable + RCD	567	0.9	567	0.9	567	0.9	473	0.75	410	0.65	378	0.6	
	Rear flat staggered terminals, Cu bars, vertical + RCD	567	0.9	567	0.9	567	0.9	504	0.8	441	0.7	378	0.6	
	Draw-out version		$I_{max}$ (A)	$I_r / I_n$	$I_{max}$ (A)	$I_r / I_n$	$I_{max}$ (A)	$I_r / I_n$	$I_{max}$ (A)	$I_r / I_n$	$I_{max}$ (A)	$I_r / I_n$	$I_{max}$ (A)	$I_r / I_n$
	DPX <sup>3</sup> 630 draw-out	Cage terminals, flexible cable	599	0.95	567	0.9	536	0.85	504	0.8	473	0.75	441	0.7
Rear flat terminals, flexible cable		599	0.95	567	0.9	536	0.85	504	0.8	473	0.75	441	0.7	
Rear flat terminals, Cu bars, vertical		599	0.95	567	0.9	536	0.85	504	0.8	473	0.75	441	0.7	
DPX <sup>3</sup> 630 draw-out + RCD	Cage terminals, flexible cable + RCD	536	0.85	504	0.8	473	0.75	441	0.7	410	0.65	378	0.6	
	Cage terminals, Cu bars + RCD	536	0.85	504	0.8	473	0.75	441	0.7	410	0.65	378	0.6	
	Rear flat terminals, flexible cable + RCD	536	0.85	504	0.8	473	0.75	441	0.7	410	0.65	378	0.6	
	Rear flat terminals, Cu bars, vertical + RCD	536	0.85	504	0.8	473	0.75	441	0.7	410	0.65	378	0.6	

For further technical information, please contact Legrand technical support.

## B) Breaking capacity in DC (kA)

$I_{cu}$ (kA)	$I_n$ (A)	1 pole *		2 poles in series *		3 poles in series *		
		60 V	60 V	110 V	250 V	110 V	250 V	500 V
36	250 ÷ 630	35	35	35	35	35	35	35
50	250 ÷ 630	35	50	35	35	50	35	35
70	250 ÷ 630	35	50	35	35	50	35	35
100	250 ÷ 630	35	50	35	35	50	35	35

These values are applied to DC networks insulated from the ground (*this diagram applies to both 3P and 4P circuit breakers*):

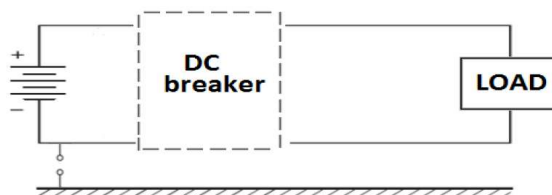

\* Connection modality of the DC breaker:

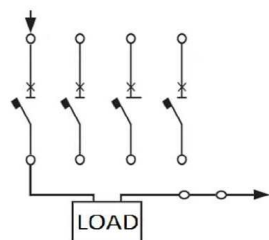

1 pole

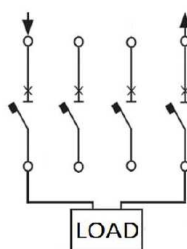

2 poles in series

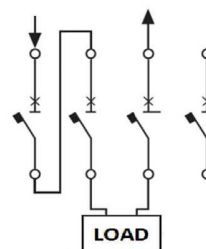

3 poles in series