

- 1 Bouton de TEST bloc différentiel
- 2 Led de signalisation
- 3 Bouton de navigation
- 4 Bouton de réglage
- 5 Sélecteur de test diélectrique
- 6 Bouton test mécanique
- 7 Emplacement batterie
- 8 Ecran

- 1 Earth Leakage TEST button
- 2 Indications led
- 3 Navigation button
- 4 Setting button
- 5 Mechanical release selector / dielectric test
- 6 Mechanical test button
- 7 Battery compartment
- 8 Display

- 1 Aardlek TEST knop
- 2 Signalerings LED
- 3 Navigatie knop
- 4 Set knop
- 5 Mechanische selector voor diëlectrische test
- 6 Mechanische Test
- 7 Batterijen compartiment
- 8 Display

- 1 Botón de test diferencial
- 2 Led de señalización
- 3 Pulsador de navegación
- 4 Pulsador de reglaje
- 5 Selector de desbloqueo mecánico / test dieléctrico
- 6 Botón de test mecánico
- 7 Compartimento de la batería
- 8 Pantalla

- 1 Tasto TEST differenziale
- 2 Led segnalazioni
- 3 Pulsante di navigazione
- 4 Pulsante di impostazione
- 5 Selettore sgancio meccanico / Test Dielettrico
- 6 Tasto test meccanico
- 7 Vano batterie
- 8 Display

- 1 Botão de TESTE diferencial
- 2 LED de sinalização
- 3 Botão de navegação
- 4 Botão de regulação
- 5 Selector disparo manual / teste dieléctrico
- 6 Botão de teste mecânico
- 7 Compartimento das pilhas
- 8 Ecrã LCD

- 1 Przycisk TEST członu różnicowoprądowego
- 2 Diody sygnalizacyjne LED
- 3 Przycisk nawigacyjny
- 4 Przycisk regulacyjny
- 5 Selektor mechanicznego wyzwolenia / test izolacji
- 6 Przycisk testu mechanizmu
- 7 Komora baterii
- 8 Wyświetlacz

- 1 Kaçak akım TEST butonu
- 2 Led'li sinyal lambaları
- 3 Menü gezintisi tuşları
- 4 Ayar düğmesi
- 5 Mekanik açtırma/ dielektrik test seçici
- 6 Mekanik test butonu
- 7 Pil yuvası
- 8 Gösterge ekranı

**INSERTION DES BATTERIES / BATTERY INSERTION / BATTERIJEN PLAATSEN
COLOCACIÓN DE LA BATERÍA / INSERIMENTO BATTERIA / INSERÇÃO DAS PILHAS
MONTAŻ BATERII / PILLERIN YERLEŞTIRILMESİ**

1

En fonctionnement sur batterie, l'écran s'éteint après 10s si il n'est pas utilisé. / If battery powered the display switch off after 10 s if not used.
Het display schakelt uit wanneer het 10 seconde niet wordt gebruikt. / Si se alimenta con batería, la pantalla se apaga tras 10s sin utilizarla.
Se alimentato in batteria il display si spegne dopo 10s se inutilizzato. / Se alimentado por pilhas o ecrã apaga-se após 10 s sem utilização.
Przy zasilaniu z baterii wyświetlacz wyłączy się po 10 sekundach bezczynności. / Eğer pil üzerinden besleniyorsa kullanılmadan 10s kaldığında ekran kapanır.

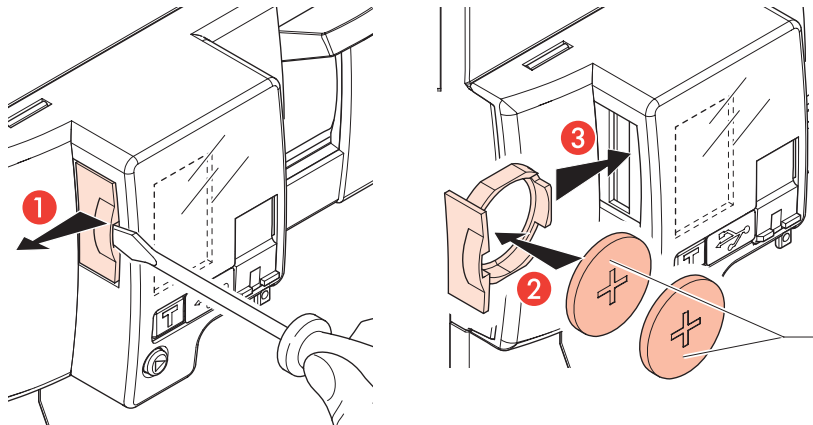

Batteries 2x CR1616 3V
Batteries 2x CR1616 3V
Batterijen 2x CR1616 3V
Baterias 2x CR1616 3V
Batterie 2x CR1616 3V
Baterias 2x CR1616 3V
Baterie: 2x CR1616 3V
2x CR1616 3V pil



A la fin de leur cycle de vie, recycler les batteries conformément à la directive européenne 2006/66/CE traitant des batteries, accumulateurs et déchets associés.
At the end of life cycle, process the included batteries according to the EU directive 2006/66/CE about the batteries, accumulators and relative wastes.
Gebruikte batterijen afvoeren volgens EU richtlijn 2006/66/CE Batterijen en accu's
Cuando se agoten las baterías, reciclarlas conforme a la directiva europea 2006/66/CE relativa a baterías, acumuladores y residuos asociados
A fine vita, smaltire le batterie incluse nell'articolo secondo quanto prescritto dalla direttiva 2006/66 CE relativo a pile, accumulatori e relativi rifiuti.
No final do ciclo de vida, processe as pilhas de acordo com a directiva UE de reciclagem de pilhas e acumuladores
W celu recyklingu zużytych baterii należy postępować zgodnie z dyrektywą EU 2006/66/CE dotyczącą baterii i akumulatorów, oraz związanych z tym odpadów.
Piller, ömürleri sona erdiğinde piller,aküler ve bağlı atıklarila ilgili EU2006/66/CE direktiflerine uygun olarak geri dönüştürülmelidir.

PARAMETRES / SETTINGS / INSTELLINGEN / PARÁMETROS / IMPOSTAZIONI / REGULAÇÕES / REGULACJA / AYARLAR

2

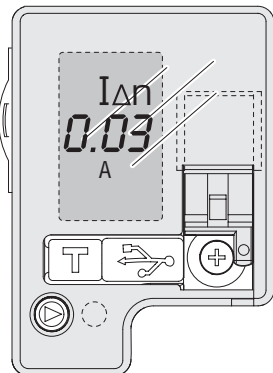

- * Réglages par défaut IΔn (A) = 0,03 - Δt (s) = 0
- * Factory setting IΔn (A) = 0,03 - Δt (s) = 0
- * Impostazioni di fabbrica IΔn (A) = 0,03 - Δt (s) = 0
- * Fabrika ayarı IΔn (A) = 0,03 - Δt (s) = 0

		IΔn = [A]			
		* 0.03	0.3	1	3
* 0	Δt [s]	OK	OK	OK	OK
0.3		NO	OK	OK	OK
1		NO	OK	OK	OK
3		NO	OK	OK	OK



Avec un seuil différentiel de IΔn = 0.03A, le temps de déclenchement est réglé automatiquement à Δt (s) = 0
With differential threshold of IΔn = 0.03A, the trip time automatically sets to Δt (s) = 0
Wanneer de differentiaalstroom is ingesteld op IΔn = 0.03A wordt de reactievertaging automatisch Δt (s) = 0
Con un umbral de disparo diferencial de IΔn = 0.03A, el tiempo de desconexión está ajustado automáticamente a Δt (s) = 0
Con soglia differenziale di IΔn = 0.03A il tempo di intervento automaticamente si imposta su Δt (s) = 0
Com regulação diferencial de IΔn = 0.03A o tempo de intervenção passa automaticamente a Δt (s) = 0
Dla nastawy czlonu różnicowoprądowego równej IΔn = 0.03A, czas zadziałania zostaje automatycznie ustawiony na Δt (s) = 0
Kaçak akım eşik değeri IΔn = 0.03A olarak ayarlandığında zaman gecikmesi otomatik olarak Δt (s) = 0 a getirilir.

1

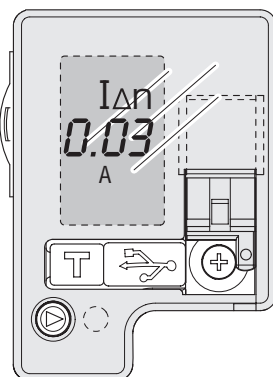

**PARAMETRES IΔn et Δt possibles
SETTINGS IΔn and Δt possible
instellen van IΔn en Δt mogelijk
AJUSTE IΔn y Δt posible
IMPOSTAZIONE IΔn e Δt possibili
REGULAÇÕES IΔn e Δt possíveis
Możliwość REGULACJI IΔn oraz Δt
Mümkün olan IΔn ve Δt ayarları**



2

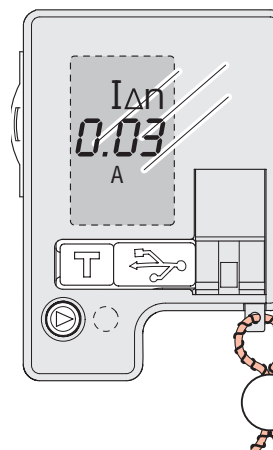

**CONSULTATION
CONSULTATION
ALLEEN AF/UITLEZEN
CONSULTA
CONSULTAZIONE
VERIFICAÇÕES
SPRAWDZENIE
INCELEME**



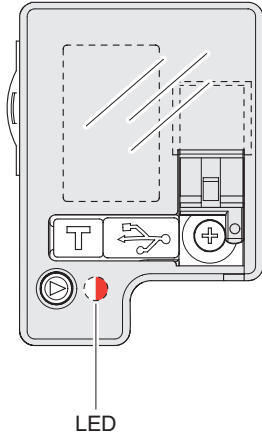

Double color led / LED bicolore / Led Bicolore / Çift renkli Led		
Signal / Indication / Segnalazione / Sinyal	Événements / Event / Eventi / Olay	Priorité / Priority / Priorità / Öncelik
LED verte allumée Green led on Led Verde acceso Yeşil Led sabit yanıyor	IΔn en-dessous du seuil IΔn under limit IΔn sotto soglia IΔn limitin altında	3
LED verte clignotante Green led blinking Led Verde lampeggiante Yeşil Led yanıp sönüyor	Réglage incorrect - Réglage en cours Setting mistake - Setting in process Regolazione non corretta - Regolazione in corso Ayarlama hatası - Ayarlama yapılıyor	3
LED rouge allumée Red led on Led Rosso acceso Kırmızı Led sabit yanıyor	IΔn supérieur à 45% du seuil défini IΔn higher than 45% of settled limit IΔn superiore al 45% della soglia imposta IΔn ayarlanan limit değerinin %45'inin üzerinde	3
LED rouge clignotante Red led blinking Led Rosso lampeggiante Kırmızı Led yanıp sönüyor	IΔn supérieur à 60% du seuil défini IΔn higher than 60% of settled limit IΔn superiore al 60% della soglia imposta IΔn ayarlanan limit değerinin %60'ının üzerinde	3
LED verte et rouge en clignotement alterné Green and Red alternately blinking Led Verde e Led Rosso lampeggianti alternativamente Yeşil ve Kırmızı Ledler sırayla yanıp sönüyor	Température > 85°C Temperature > 85°C Temperatura > 85°C Sıcaklık > 85° C	1

En cas de plusieurs événements simultanés, celui dont la priorité est la plus élevée sera signalé. Le niveau 1 de priorité est le plus élevé.

If more events were at the same time, the signal would be the one with highest priority. The highest priority is 1

Se più eventi fossero concomitanti, la segnalazione visualizzata sarà quella a priorità più elevata. La priorità maggiore è la 1

Aynı anda birden fazla olay söz konusu ise en öncelikli olay gösterilir. En yüksek öncelik değeri 1'dir.

- **Affichage écran / Service signals / Service signalen / Señalización de servicio / Segnalazioni di servizio / Indicações de serviço / Komunikaty serwisowe / Servis sinyalleri**

L'affichage des valeurs de $I_{\Delta n}$ et de Δt sur l'écran alterne à une fréquence de 3 s

The viewing on display of set values of $I_{\Delta n}$ and Δt takes place alternately with a viewing frequency of 3 s.

De waarden $I_{\Delta n}$ and Δt zijn met een interval van 3 s op het display af te lezen.

La visualización en pantalla de los valores de ajuste de $I_{\Delta n}$ y Δt se sucede alternativamente con una frecuencia de visualización de 3 segundos.

La visualizzazione su display dei valori impostati di $I_{\Delta n}$ e Δt avviene alternativamente con una frequenza di visualizzazione di 3 sec."

A visualização no ecrã dos valores regulados $I_{\Delta n}$ e Δt , ocorre alternadamente com uma frequência de 3 seg.

Wyświetlanie ustawionych wartości $I_{\Delta n}$ i Δt następuje naprzemiennie z częstotliwością 3s.

Ayarlanan $I_{\Delta n}$ ve Δt değerleri 3 saniyelik sürelerle ekranda dönüşümlü olarak gösterilir.

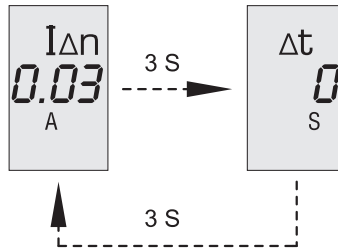

En cas de batterie faible.

In case of low battery.

Wanneer de batterij leeg raakt wordt.

En caso de nivel bajo de batería.

In caso di batterie a livello basso.

Se bateria com carga baixa.

W przypadku niskiego poziomu baterii.

Piller zayıfladığında ilave olarak.

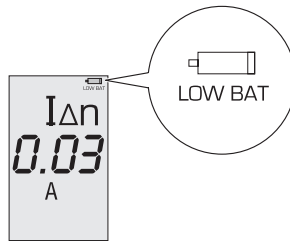

Navigation / Navigation / Navigatie / Navegación / Navigazione / Navegação / Nawigacja / Menüde Gezinme

Mode configuration / Setup mode / Setup Modus / Modo de configuración / Modalità di set up / Modo de regulação / Tryb konfiguracyjny / Uyarlama modu

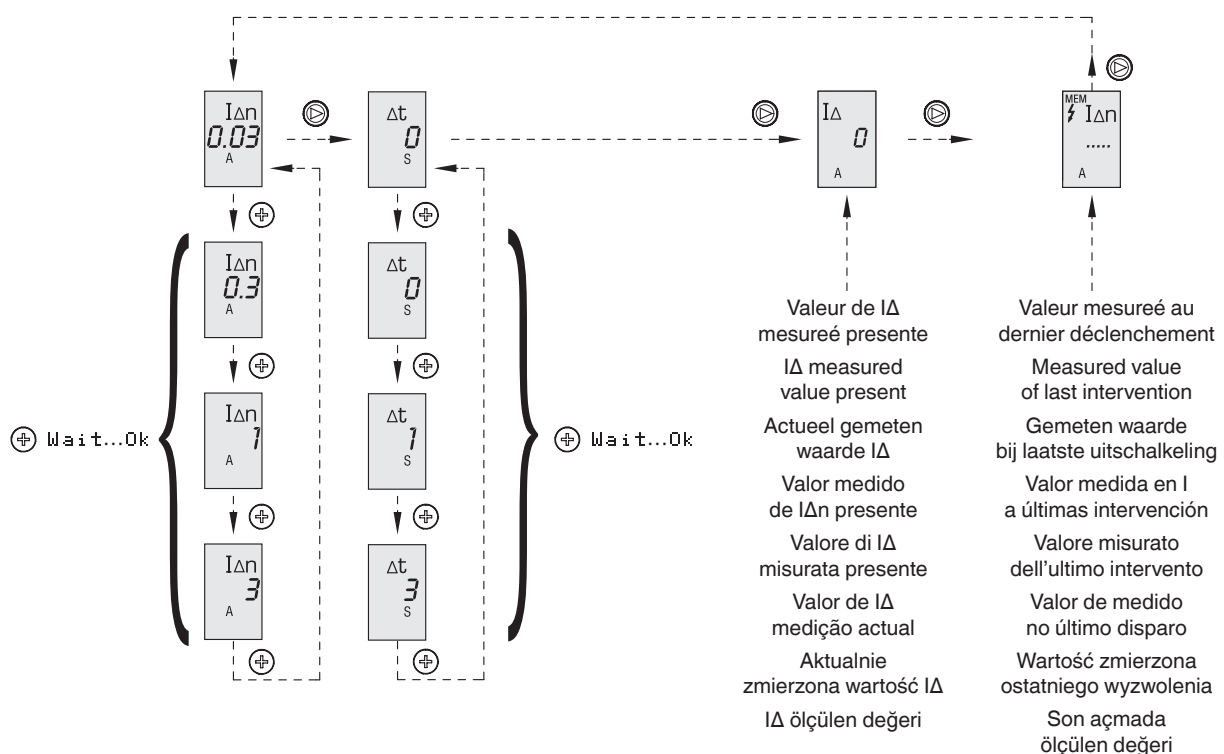

DESCRIPTION DE L'UTILISATION DU SELECTEUR DE TEST DIELECTRIQUE / WORKING CONDITIONS
DESCRIPTORS OF DIELECTRIC TEST SELECTOR / OMSCHRIJVING DIËLEKTRISCHE TEST SELECTOR /
'DESCRIZIONE DELLE CONDIZIONI DI LAVORO DEL SELETTORE TEST DIELETTICO / DESCRIZIONE DAS CONDIÇÕES DE
FUNCIONAMENTO DO SELETOR DE TESTE DIELÉCTRICO / OPIS TRYBÓW PRACY PRZEŁĄCZNIKA TESTU
IZOLACJI / DİELEKTRİK TEST SEÇİCİNİN ÇALIŞMA KOŞULU TANIMLARI

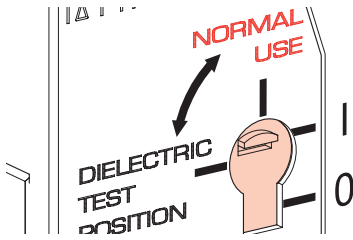

Position d'utilisation normale, différentiel actif.
 Normal running position, residual current device active.
 Posizione di normale utilizzo, differenziale attivo.
 Normal çalışma konumu, artık akım koruması devrede.

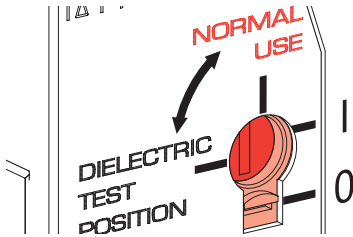

Position de blocage en position ouverte avec circuit électronique connecté.
 OPEN blocked position with electronic circuit inserted.
 Posizione di blocco in aperto con circuito elettronico collegato.
 AÇIK konumda kilitleme, elektronik devre çalışır.

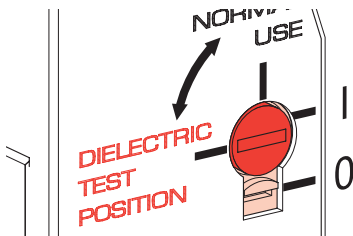

Position de test diélectrique, appareil bloqué en position ouverte, circuit électronique coupé.
 Dielectric test position, OPEN device, electronic circuit isolated.
 Posizione di test dielettrico, apparecchio bloccato in aperto, circuito elettronico sezionato.
 Dielektrik test konumu, Şalter AÇIK ve elektronik devre yalıtılmış.

TEST DIELECTRIQUE / DIELECTRIC TEST / DIËLEKTRISCHE TEST / TEST DIELÉCTRICO / TEST DIELETTICO /
TESTE DIELÉCTRICO / PRÓBA IZOLACJI / DİELEKTRİK TEST

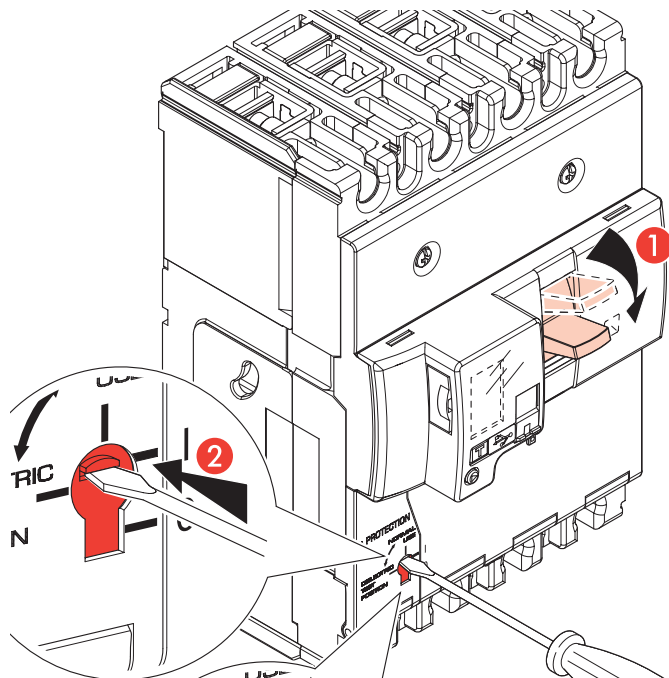

Essai de l'isolement de l'installation.
 Installation insulation test.
 Prova di isolamento impianto.
 Tesisatın yalıtım testi.

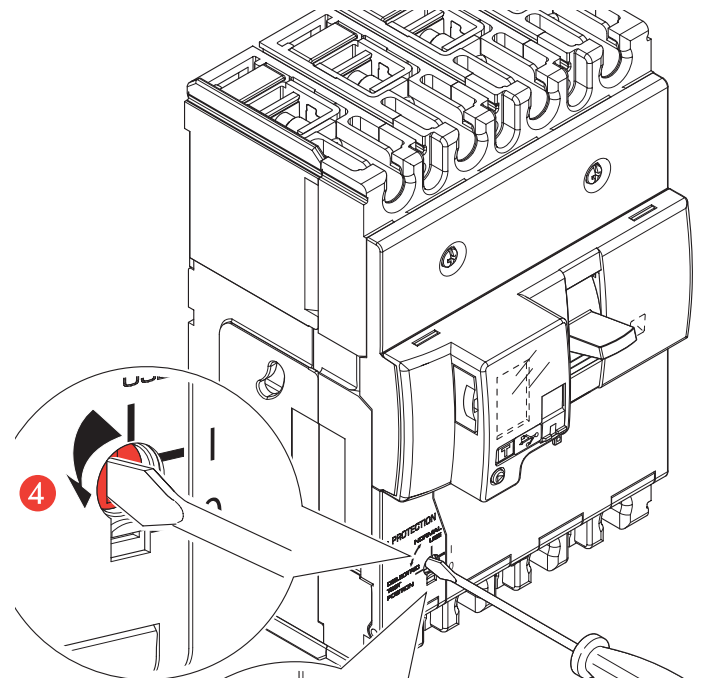

Exclusion du circuit intérieur.
 Exclusion of internal circuit.
 Esclusione circuito interno.
 Cihazın iç elektriksel devresi yalıtılır.

6b

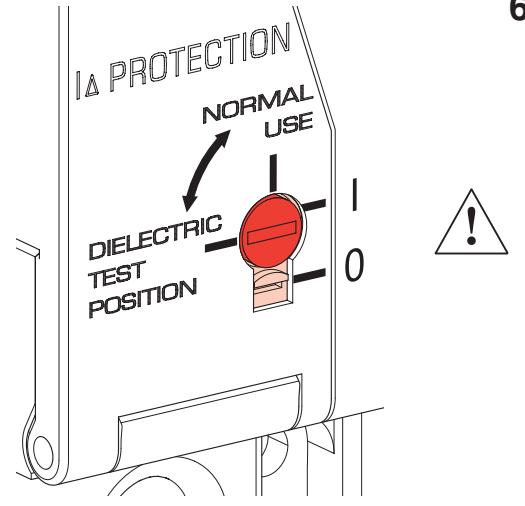
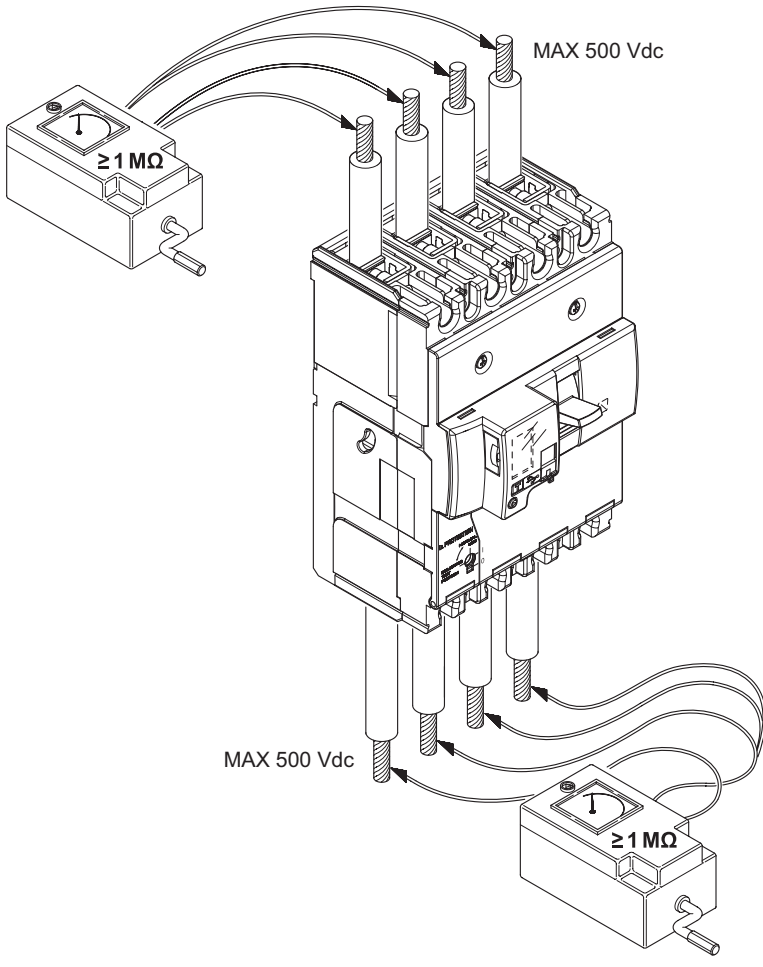

Exclusion du circuit interieur.
 Exclusion of internal circuit.
 Esclusione circuito interno.
 Cihazın iç elektriksel devresi yalıtılır.

6c

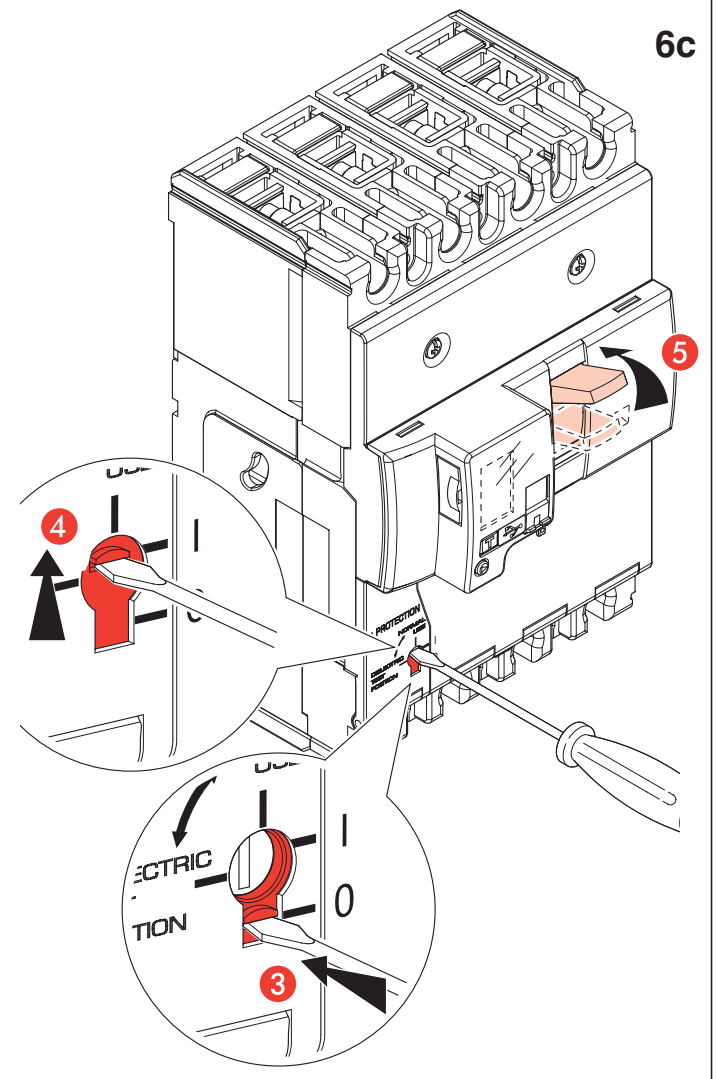
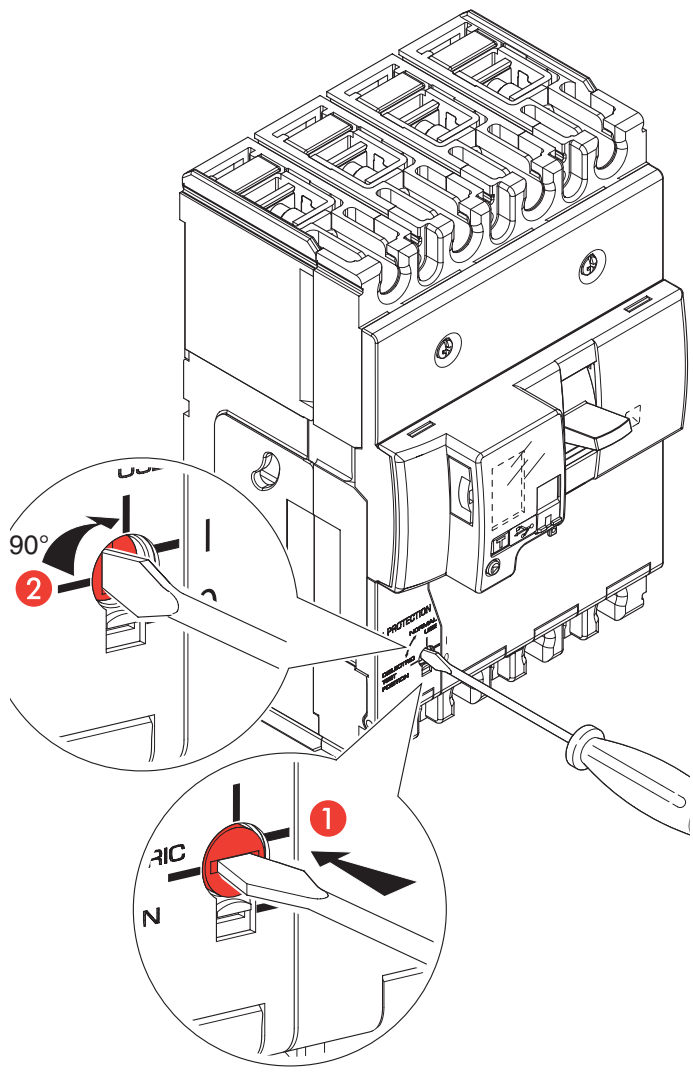

**ESSAI DE DECLENCHEMENT DIFFERENTIEL / TEST OF RESIDUAL CURRENT TRIPPING /
 TEST VAN DIFFERENTIEELSTROOM AFSCHAKELING / TEST DE DESCONEXIÓN DIFERENCIAL
 TEST SGANCIO DIFFERENZIALE / TESTE DE DISPARO DIFERENCIAL /
 TEST CZŁONU RÓŻNICOWOPRĄDOWEGO / ARTIK AKIMLA AÇMANIN TESTI.**

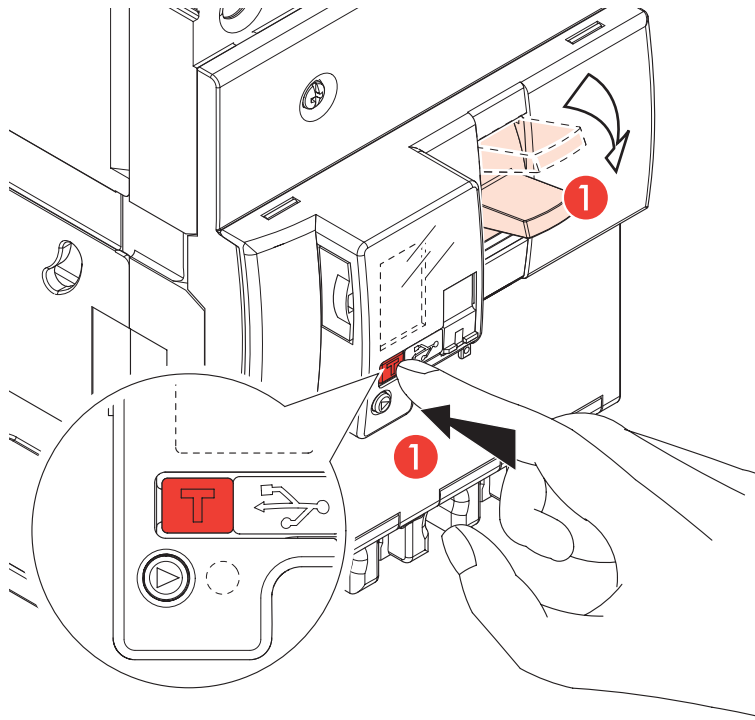

Essai de déclenchement différentiel.
 Test of residual current tripping.
 Prova d'intervento differenziale.
 Artık akımla açmanın testi.



Répéter cet essai mensuelle pendant l'exercice.
 Repeat this test monthly during service.
 Ripetere questa prova mensilmente durante l'esercizio.
 Çalışma süresince aylık bu testi gerçekleştirin.

Schéma interne de l'appareil magnétothermique avec différentiel intégré
 Internal diagram of breaker with integrated Earth leakage
 Intern schema van vermogensautomaat met ingeerd aardlekblok
 Esquema interno del aparato magnetotérmico con diferencial integrado
 Schema interno apparecchio magneto termico con differenziale integrato
 Esquema interno de aparelho magnetotérmico com diferencial integrado
 Schemat wewnętrzny wyłącznika magneto-termicznego ze zintegrowanym członem różnicowoprądowym
 Dahili kaçak akım modüllü termik manyetik şalterin iç bağlantı şeması

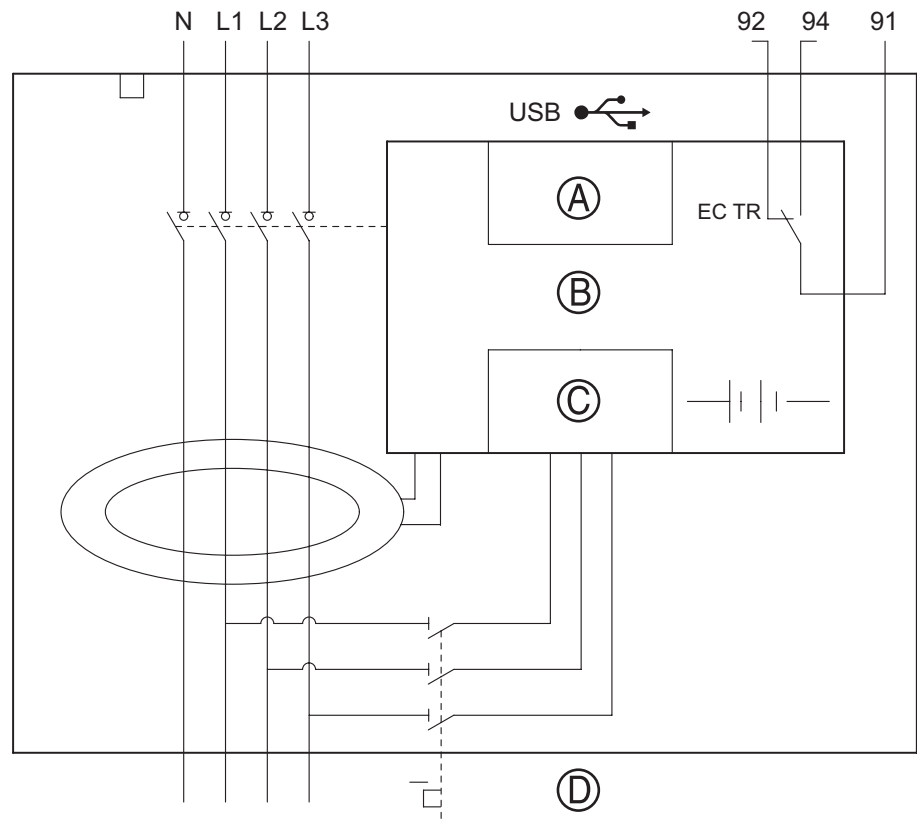
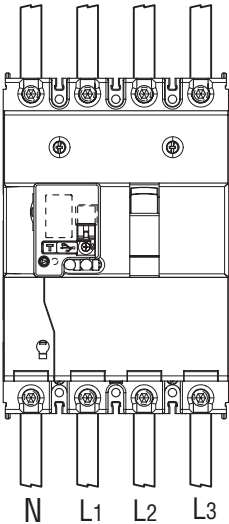

- (A)** Alimentation externe / External power /
 Externe spanning / Alimentación externa
 Alimentazione esterna / Alimentação externa /
 Zasilanie zewnętrzne / Harici besleme
- (B)** Bloc différentiel / Earth Leakage module
 Aardlek module / Bloque diferencial
 Modulo differenziale / Módulo diferencial
 Moduł różnicowoprądowy / Kaçak akım bloğu
- (C)** Alimentation directe / Direct power
 Directe voeding / Alimentación directa
 Alimentazione diretta / Alimentação directa
 Zasilanie bezpośrednie / Doğrudan besleme
- (D)** Test diélectrique / Dielectric Test
 Diélectrische test / Test dieléctrico
 Test dielettrico / Teste dieléctrico
 Próba izolacji / Dielektirk test

Lorsqu e le délai de non-déclenchement a été réglé sur «instantané», les temps de déclenchement sont conformes au graphique suivant:

Tripping curve when tiem delay is settled on "instantaneous":

I tempi di sgancio, quando il tempo di non intervento è regolato su "istantaneo" sono conformi al seguente grafico:

Zaman gecikmesi anlık (instantaneous) olarak ayarlandığında açma eğrisi:

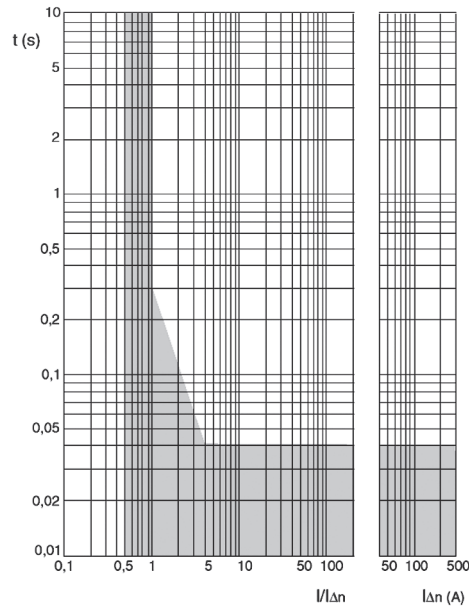

Δt=0s

Lorsque le délai de non-déclenchement a été réglé sur 0,3s, 1s et 3s, les temps de déclenchement sont conformes au graphique suivant:

Tripping curves when time delay is settled on 0.3s, 1s, 3s:

I tempi di sgancio, quando il tempo di non intervento è regolato su 0.3s, 1s, 3s sono conformi al seguente grafico:

Zaman gecikmesi 0,3s, 1s, 3s olarak ayarlandığında açma eğrisi:

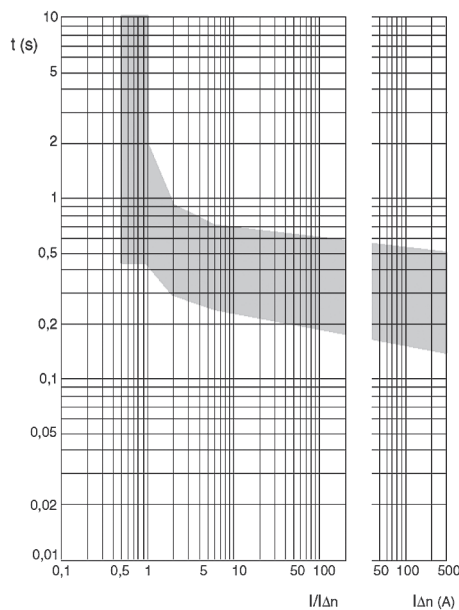

Δt=0,3s

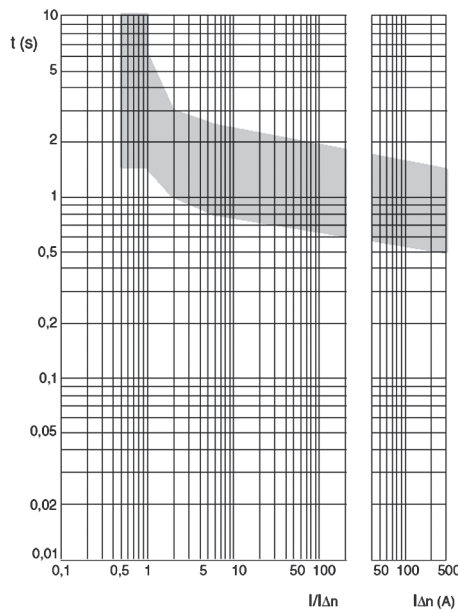

Δt=1s

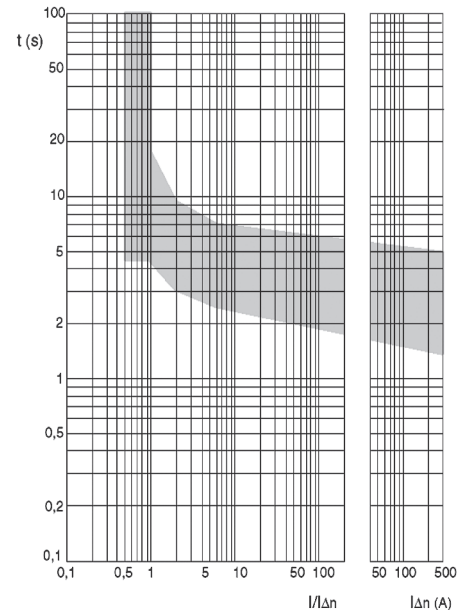

Δt=3s